

## **B. DESCRIPTION OF THE PROPOSED PROJECT**

---

### **B.1 INTRODUCTION**

Section B describes the Bolsa Chica Water Transmission Line and Wastewater Service Project proposed by Southern California Water Company (SCWC). The information presented in this section is intended to provide a common understanding of the project parameters as they are analyzed in the Environmental Impact Analysis section (Section C). Aspects of the project that are specific to particular issue areas (such as Air Quality) are presented in the discussions of those issue areas in Section C.

Section B.2 provides an overview of the Proposed Project and Section B.3 describes the location of the Proposed Project. Background information on the project applicant (SCWC) and a description of the CPUC's regulatory authority over the Proposed Project are presented in Section B.4. The objectives for the Proposed Project are stated in Section B.5. Section B.6 describes components of the proposed Bolsa Chica Water Line and Wastewater Service Project in detail, with additional details in Sections B.7 (Project Construction), and B.8 (Operation and Maintenance). Section B.9 provides a description of the intended uses of the EIR and anticipated public agency actions.

### **B.2 PROJECT OVERVIEW**

SCWC proposes to construct an underground water transmission line to deliver water to the Bolsa Chica Planned Community, a proposed residential development located at the southerly terminus of Bolsa Chica Street in unincorporated territory in western Orange County (see Section B.3 for a description of the project location). The water line would extend from SCWC's existing domestic water system in the City of Cypress to the Bolsa Chica Planned Community site (a total distance of approximately 6.7 miles), terminating at a 4-million gallon underground water storage reservoir to be constructed on the residential development site. Additional water facilities planned for the Bolsa Chica Planned Community site include a distribution pump station, a backbone water distribution system, and a groundwater well with wellhead treatment facilities. These on-site water distribution facilities were previously subject to environmental review in the *1996 Recirculated Draft Environmental Impact Report for the Bolsa Chica Report Local Coastal Program* (County of Orange, 1996; see Section A.4). The proponent for the Bolsa Chica Planned Community project is Hearthside Homes, Inc.

An on-site sewage collection system is planned to serve the Bolsa Chica Planned Community, including local sewage collector lines, a sewage lift station, and a force main required to connect to the facilities of the Orange County Sanitation District (OCSD). All sewage generated by the residential development would flow by gravity to the proposed sewage lift station where it would be pumped to an existing OCSD 21-inch trunk sewer located in Los Patos Avenue. OCSD would provide sewage treatment and disposal services for the Bolsa Chica Planned Community. SCWC would operate and maintain the on-site wastewater collection facilities. The on-site wastewater facilities were previously examined in the *1996 Recirculated Draft Environmental Impact Report for the Bolsa Chica Report Local Coastal Program* (County of Orange, 1996; see Section A.4).

### **B.3 PROJECT LOCATION**

The proposed Bolsa Chica Water Transmission Line project is located in western Orange County, California. The proposed 6.7-mile underground water line would extend from SCWC's existing domestic water system in the City of Cypress to the Bolsa Chica Planned Community site, crossing through portions of the cities of Cypress, Los Alamitos, Garden Grove, Seal Beach, Westminster, and Huntington Beach. The water line would originate at its proposed point of connection to SCWC's West Orange County System at the intersection of Orangewood Avenue and Valley View Street, and would terminate at a planned underground reservoir on the Bolsa Chica Planned Community site. Figure B-1 depicts the regional location of the Proposed Project and Figure B-2 illustrates the proposed water line route. The proposed water line route is described in detail in Section B.6.1.

The Bolsa Chica Planned Community site encompasses approximately 230 acres on Bolsa Chica Mesa in Orange County's Bolsa Chica Local Coastal Program (LCP) Area (see Figure B-2). The development site is located along the south side of Los Patos Avenue between Bolsa Chica Street and the Pacific Coast Highway. The Bolsa Chica Planned Community site is located within the Coastal Zone in unincorporated territory of Orange County. The construction of up to 1,235 residential dwelling units is currently planned on the site pending approval of a Coastal Development Permit by the County of Orange.

### **B.4 PROJECT APPLICANT**

SCWC has submitted two applications for Certificates of Public Convenience and Necessity to the California Public Utilities Commission (CPUC). The first application (A.98-11-003) requests approval to extend SCWC's existing West Orange County System by constructing a 6.7-mile water transmission line to serve the Bolsa Chica Planned Community on Bolsa Chica Mesa. The second application (A.98-11-015) requests approval for SCWC to operate and maintain a wastewater collection system that would be constructed to serve the Bolsa Chica Planned Community.

The applicant, Southern California Water Company (SCWC), is an investor-owned public utility engaged principally in the purchase, production, distribution, and sale of water to over 240,000 customers. SCWC operates 41 separate water systems in 10 counties in the State of California. SCWC currently supplies domestic water to over 25,000 customers in western Orange County, including portions of the cities of Los Alamitos and Cypress. SCWC receives water for its West Orange County System from two sources: (1) treated, imported water from the Colorado River and State Water Project; and (2) local groundwater (from the Santa Ana River Groundwater Basin). The West Orange County System is part of SCWC's Orange County District, which is comprised of four water systems that serve separate areas: the West Orange County System, the Placentia System, the Yorba Linda System, and the Cowan Heights/Lemon Heights System. The West Orange County System serves the

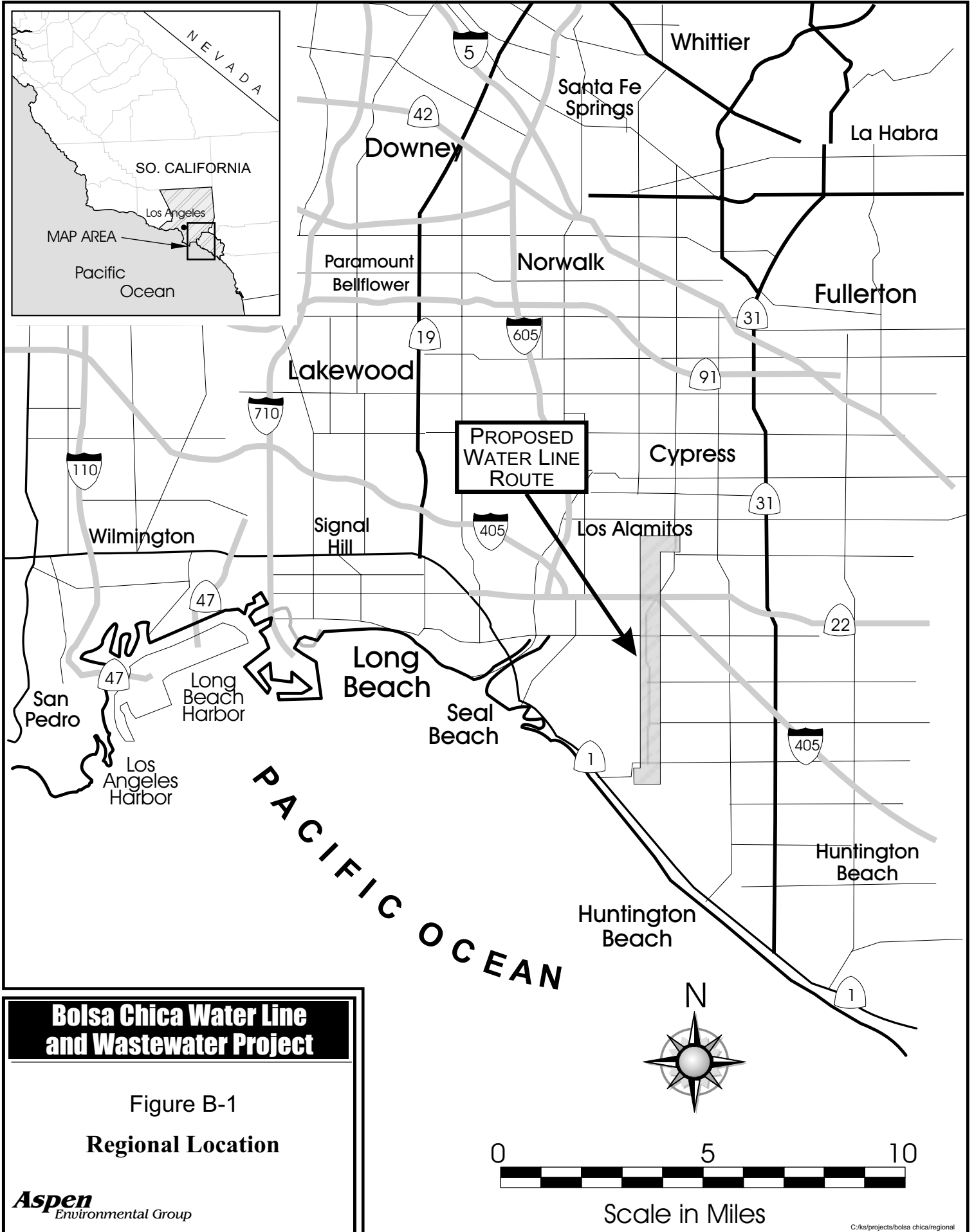

**Bolsa Chica Water Line and Wastewater Project**

Figure B-1  
**Regional Location**

**Aspen**  
 Environmental Group

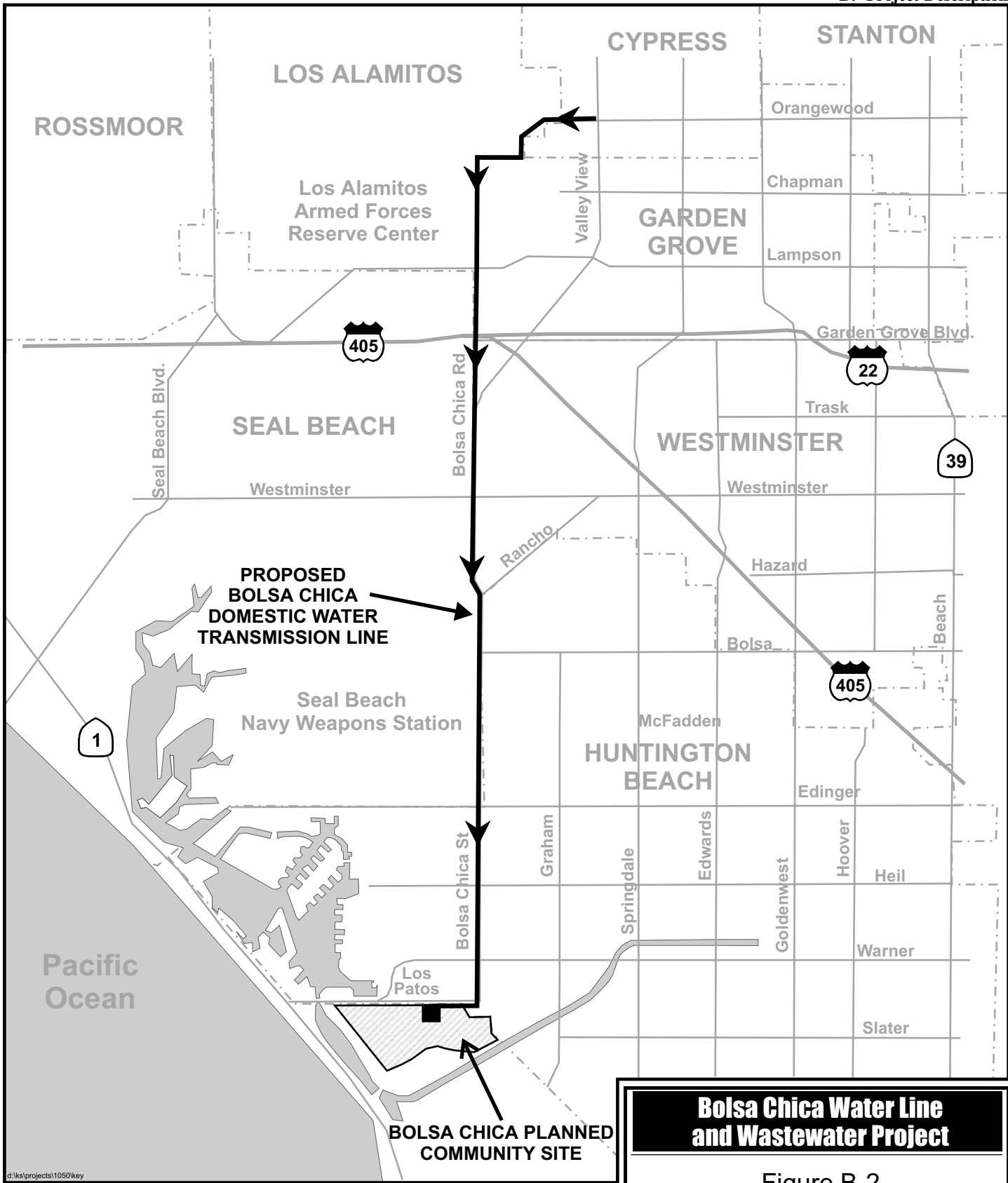

d:\ks\projects\11050\key



Scale in Miles

**Bolsa Chica Water Line and Wastewater Project**

Figure B-2  
 Proposed Water Transmission Line Route

**Aspen**  
 Environmental Group

cities of Cypress, Los Alamitos, and Stanton as well as small portions of Buena Park, Garden Grove, La Palma, and Seal Beach. In December 1997, there were more than 40,000 active customers in the Orange County District, 98% of whom were either residential or business customers.

In 1996-97, approximately 63% of the water supply in the Orange County District was obtained from 27 SCWC-owned wells located within the District. The storage facilities in the Orange County District consist of steel tanks and concrete reservoirs. Water is pumped from these storage reservoirs, which have a combined storage capacity of 11.4 million gallons, into the distribution system. As of December 1996, there were approximately 2,098,425 feet of distribution main in the Orange County District. The District has an operating capacity of 58,992 gallons per minute (gpm), a standby capacity of 3,709 gpm and an additional peaking capacity of 11,980 gpm (SCWC 1998a, p. 4).

The West Orange County System has an operating capacity of 10,386 gpm from active groundwater wells as well as 2,512-gpm capacity from standby wells. The West Orange County System has three connections to MWD feeder mains, which provide 24,700 gpm maximum capacity. The system has 6,600 gpm of peaking capacity from storage of which 1,155 gpm is available to meet maximum day demand. Accordingly, the West Orange County System has 36,241 gpm of water flow available from all sources to meet maximum day demands.

## **B.5 PROJECT OBJECTIVES**

The water transmission pipeline has been proposed with the basic objective of providing the Bolsa Chica Planned Community with a reliable, long-term domestic water supply. The proposal is designed to meet the projected domestic water demands and fire flow requirements of the Bolsa Chica Planned Community project. The Proposed Project is also concerned with ensuring that the planned residential community has an adequate and reliable wastewater collection and disposal system. Annexation into Districts 3 and 11 of the OCSD is proposed to provide the required wastewater treatment and disposal. A pre-annexation agreement has already been executed between Hearthside Homes, Inc., and the OCSD. SCWC's objectives for the Bolsa Chica Water Transmission Line and Wastewater Service Project are summarized below:

- Provide reliable, long-term domestic water supply to the Bolsa Chica Planned Community.
- Construct a water transmission system designed to meet the projected domestic water demands and fire protection needs of the Bolsa Chica Planned Community.
- Ensure adequate and reliable wastewater collection and disposal service for the Bolsa Chica Planned Community.

## **B.6 PROJECT COMPONENTS**

The Proposed Project consists of two primary components: 1) a proposed 6.7-mile water transmission line to deliver water to the Bolsa Chica Planned Community site; and 2) designation of the SCWC as the wastewater management agency for the Bolsa Chica Planned Community project. In order to facilitate water and wastewater service for the Bolsa Chica Planned Community project, various on-site water storage and distribution facilities and wastewater collection facilities will need to be constructed. These water storage/distribution facilities and the wastewater collection facilities were previously included in the project analyzed in the *1996 Recirculated Draft Environmental Impact Report for the Bolsa Chica Report Local Coastal Program* (County of Orange, 1996).

### **B.6.1 DOMESTIC WATER TRANSMISSION LINE**

#### **Pipeline Components**

SCWC proposes to construct a domestic water transmission line to deliver water from its existing West Orange County System in the City of Cypress to the proposed site of the Bolsa Chica Planned Community. The pipeline would terminate at a 4-million gallon underground storage reservoir to be constructed on Bolsa Chica Mesa (see Section B.6.2). The total length of the proposed pipeline would be 35,370 linear feet (approximately 6.7 miles). Water in the pipeline would be delivered by pressure flow from the SCWC system in the City of Cypress, without pumping required along the route to deliver the water to the planned reservoir on Bolsa Chica Mesa. The pipeline would consist of 18-inch diameter, ductile iron pipe buried at a typical depth of 42 inches below the ground surface. The ductile iron pipe would be pressure class 350, with a bituminous coating and encased in a polyethylene wrap to protect against corrosion. The Ductile Iron Pipe Institute has provided soil sampling along the pipeline alignment to test corrosivity, and has recommended only the polyethylene wrap. Therefore, no cathodic protection system is proposed for the water line. Gate valves would be installed on the pipeline at average spacing of 1,000 feet to block water flow in the pipe in case repairs are required (see Figure B-3). Concrete pipe encasements would be constructed at all utility crossings. There would be a 28-inch steel casing pipe around the pipeline where it crosses under the U.S. Navy Railroad (see Figure B-4).

The pipeline has been sized to meet the domestic water demands of the proposed Bolsa Chica Planned Community at “full, planned buildout” (currently planned for 1235 dwelling units). The proposed water system has been designed to conform to the CPUC’s General Order No. 103, Rules Governing Water Service Including Minimum Standards for Design and Construction.

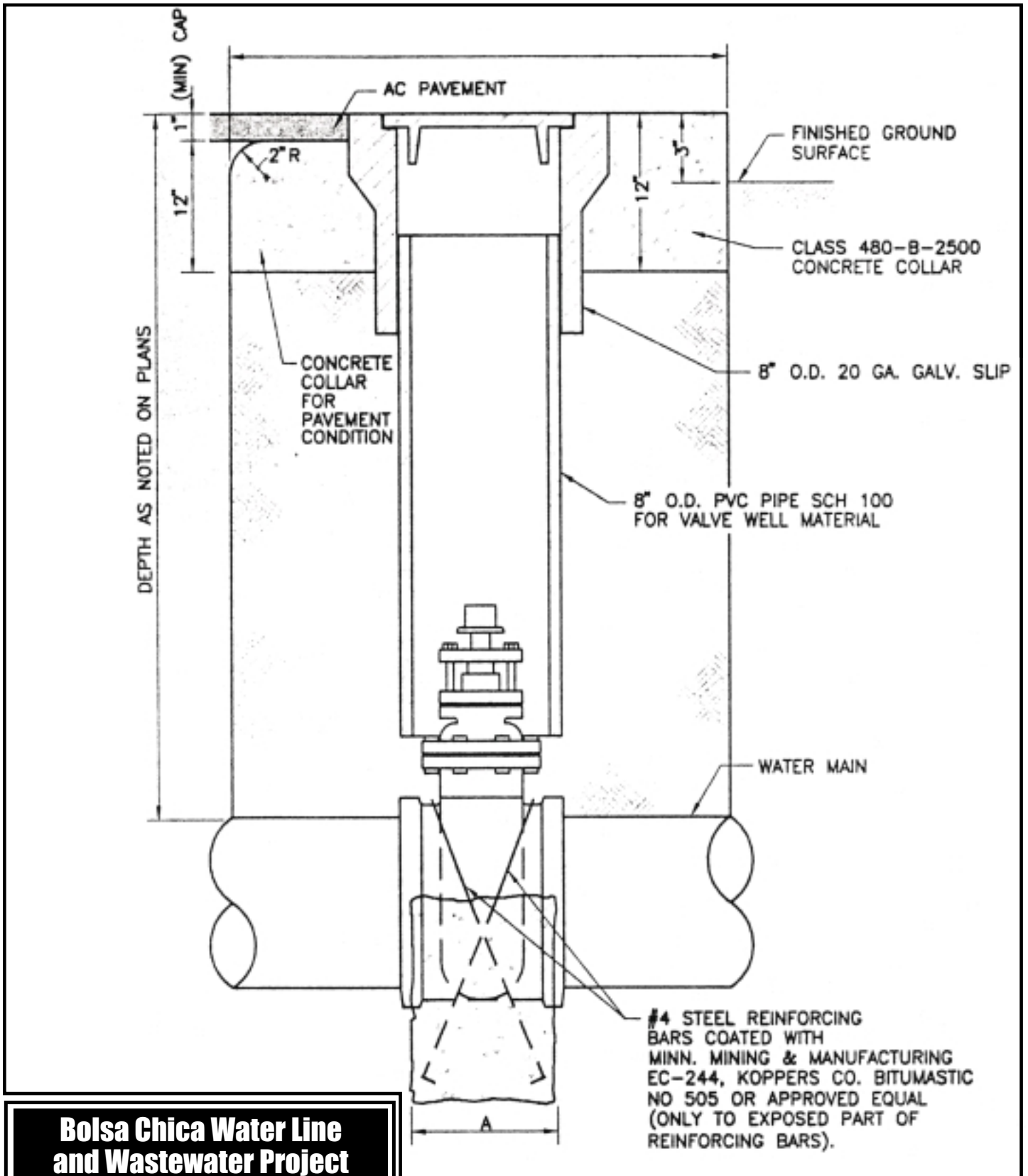

**Bolsa Chica Water Line and Wastewater Project**

Figure B-3  
 Gate Valve Detail

**Aspen**  
 Environmental Group

Note: Valves would be placed an average interval of 1000' along the pipeline.

Source: SCWC, 1997, Construction plans for the Bolsa Chica 18" Water Transmission Main

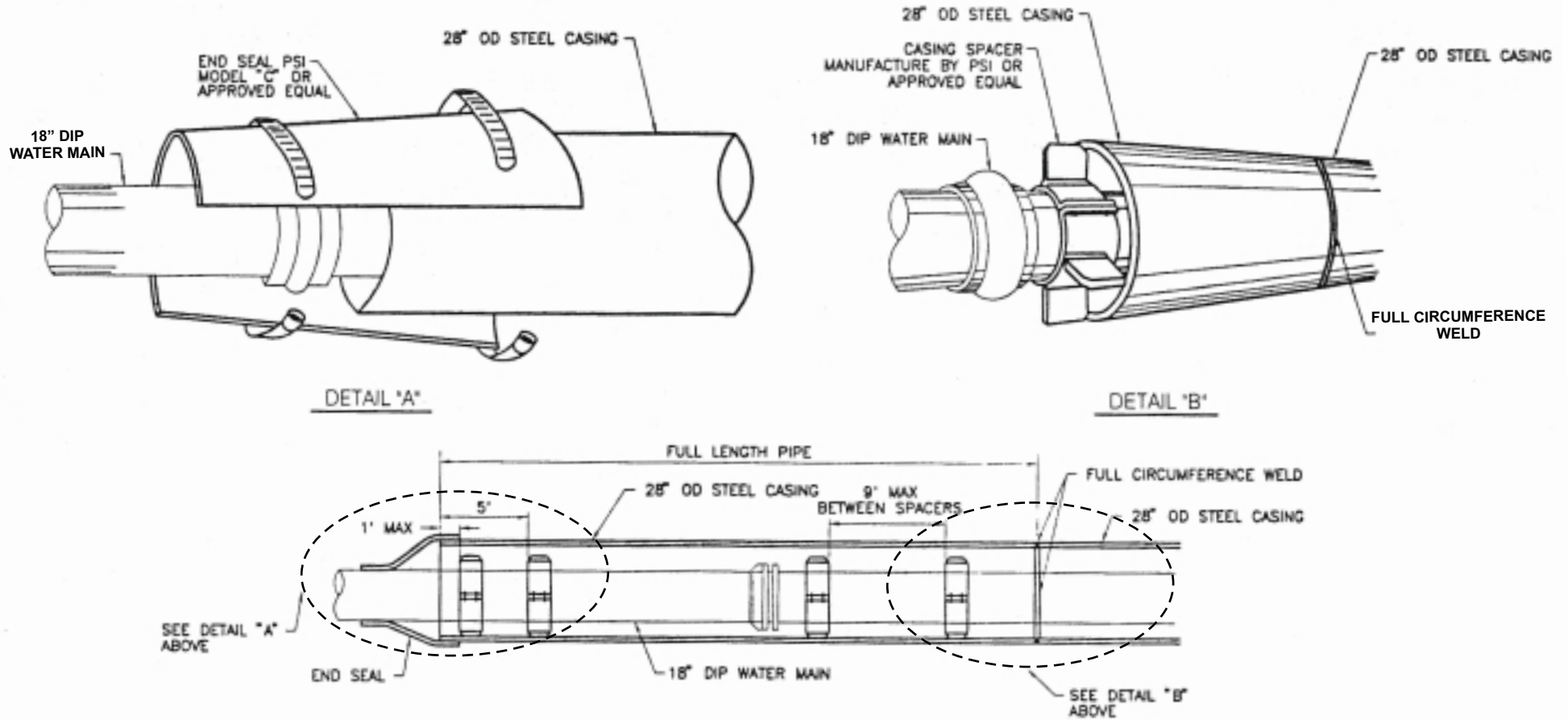

Note: The only rail crossing along the proposed pipeline route is at the U.S. Navy Railroad on Bolsa Chica Road south of Westminster Boulevard.

Source: SCWC, 1997, Construction Plans for the Bolsa Chica 18" Water Transmission Main

## Bolsa Chica Water Line and Wastewater Project

Figure B-4  
 Steel Casing Beneath  
 Railroad Crossing

**Aspen**  
 Environmental Group



The pipeline would be connected to the existing SCWC system at a 12-inch, ductile iron pipe water main in the intersection of Orangewood Avenue and Valley View Avenue. This water main has a maximum flow of 750 gallons per minute (gpm) that is under sufficient pressure to deliver water to the proposed reservoir at the Bolsa Chica Planned Community site. The existing SCWC water line alignment runs north-south along the west side of Valley View Street approximately 10 feet west of the westerly curb and gutter (Tetra Tech, 1999, p. 2).

### **Projected Water Demand**

SCWC's total available water supply in its West Orange County System is 36,241 gpm. The total daily water supply requirement for the West Orange County System at full build-out, including the proposed Bolsa Chica Planned Community, is 30,262 gpm. As a result, SCWC has an apparent excess in water supply of 5,979 gpm. The development of these values is detailed in the following paragraph.

The average daily requirement for the proposed Bolsa Chica Planned Community has been calculated to be 540 gpm from approximately 1,235 customers (SCWC 1999a, p. 11). The daily flow required by the local fire protection agency is 3,500 gpm. The minimum 2-hour total flow requirement therefore is 4,040 gpm (SCWC 1998b, p. 4). The total 2-hour flow available to the planned subdivision from SCWC is 5,152 gpm, an excess of 1112 gpm. Based on these projections, the total water supply requirement for the West Orange County System is 30,262 gpm (SCWC, 1999a, p. 11). The West Orange County System has 36,241 gpm of water flow from all sources. As a result, SCWC has an excess water supply of 5,979 gpm (SCWC, 1999a, p. 11). Therefore, SCWC has concluded that it can provide the maximum daily requirements of the planned subdivision for both domestic consumption and fire-fighting needs (SCWC, 1999a, 1999b).

### **Estimated Cost**

The total costs for the development of the proposed water supply system to service the Bolsa Chica Planned Community are estimated to be \$8,650,000. The SCWC water transmission line component of these costs is estimated at \$4,500,000 (SCWC, 1998c, p. 6-1).

### **Proposed Pipeline Route**

The proposed water line would originate in the City of Cypress, where it would connect with SCWC's existing West Orange County System. The proposed point of connection to the existing SCWC system is a 12-inch water main located at the intersection of Orangewood Avenue and Valley View Street. From this point of connection, the proposed alignment proceeds easterly along Orangewood Avenue until entering the Los Alamitos Armed Forces Reserve Center (LAAFRC), where it then proceeds in a generally southerly direction to the site of the Bolsa Chica Planned Community on Bolsa Chica Mesa. For descriptive purposes, the proposed water line route has been divided into ten segments. Table B.6-1 below describes the ten segments of the proposed alignment.

**Table B.6-1 Detailed Route Description**

Segment No.	Segment Location	Length (Feet)	Route Description	Construction Method
1	Orangewood Avenue – Valley View Street intersection to entrance of LAAFRC golf course	1,250	Public street right-of-way; the route is the westbound lane of street	Open trench
2	LAAFRC golf course parking lot and perimeter maintenance road	3,060	LAAFRC right-of-way; perimeter of the parking lot and, further south, in the service road of OCFCD's Bolsa Chica Channel.	Open trench
3	Bolsa Chica Channel maintenance road (south to Lampson Road)	3,900	Route lies on right-of-way of the OCFCD service road for Bolsa Chica Channel (route is eight feet from the outer perimeter of the easement, outside the channel).	Open trench
4	Bolsa Chica Channel (over Lampson and south to the I-405)	2,265	Route crosses Lampson on the eastern side (crossing both east and west bound lanes); then continues south on the eastern edge of the OCFCD right of way; eight feet from the outer boundary of the right of way.	Open trench
5	I-405/SR-22 freeway crossing	590	Caltrans right-of-way.	Bore & jack, steel casing
6	South on Old Bolsa Chica Road and Bolsa Chica Road from the I-405 freeway, to Westminster Ave	5,230	Public street right-of-way; northbound lanes of Old Bolsa Chica Road; quiet, low-volume street; northbound lanes at Bolsa Chica Road – busy four lane street.	Open trench
7	Under Westminster Ave, south along Bolsa Chica Road to Rancho Road.	3,540	City of Westminster; public street right-of-way (northbound lanes of Bolsa Chica Road);	Open trench with shoring through intersections. Boring and Jacking under Westminster Avenue and the Navy Railway; the Anaheim-Barber City Channel crossed by connecting to existing concrete culvert.
8	Bolsa Chica Street (from Rancho Road) south to Edinger Avenue	7,600	Route lies in public street right of way, mostly in the outer northbound lanes; the Westminster Channel would be crossed via the OCFCD right-of-way, single-span support structure.	Open trench in Bolsa Chica Street. Channel crossing: Concrete encasement approaching span abutments, support beam and hangars or truss members on support structure.
9	Bolsa Chica Street (south of Edinger Ave intersection) south to Los Patos Ave.	6,600	Route lies in public street right of way, alternating between the inner and outer northbound lanes.	Open Trench
10	Adjacent to Los Patos Avenue	1,300	Route lies in a 10-foot wide pipeline easement to the south of Los Patos Avenue.	Open trench, shoring, native backfill

Each of these segments is described in greater detail below. The pipeline route segments are displayed in Figure B-5.

***Segment 1***

The pipeline would originate in Orangewood Avenue near the intersection with Valley View Avenue, where it would be connected to the SCWC's existing system. The pipeline would be installed beneath the westbound lanes of Orangewood Avenue, six feet from the centerline of the street. The route maintains this position in the street for 1,250 feet until it reaches the LAAFRC parking lot at the end of Orangewood Avenue. The southern side of Orangewood Avenue includes a neighborhood park and

residential uses. On the northern side of the street is a business park development. The construction methods used in this segment would be trenching, shoring, and backfilling. This portion of the alignment is located within the City of Cypress.

### ***Segment 2***

In this 3,060-foot segment, the pipeline would be laid in the public utilities right-of-way that lies on the southerly perimeter of the LAAFRC property. The pipeline would be laid ten feet from the southerly boundary of the property. Upon entering the LAAFRC, approximately 500 feet of the pipeline would be laid in a generally westerly direction adjacent to the LAAFRC golf course parking lot; the pipeline route then turns southwest, following the right-of-way along the perimeter of the golf course. In this portion of the segment, the pipeline would be laid in the center of the service road, 13 feet from the edge of the LAAFRC property. The adjacent land use to the south is single-family residential. The construction methods used in this segment would be trenching, shoring, and backfilling. This portion of the alignment falls within the City of Los Alamitos.

### ***Segment 3***

This segment, which is 3,900 feet in length, begins where the pipeline enters the Orange County Flood Control District (OCFCD) right-of way, adjacent to the LAAFRC and continues south to Lampson Avenue. The OCFCD right-of-way is 75 feet wide and runs in a southerly direction at the eastern edge of the LAAFRC property. The pipeline would be laid under the existing, paved maintenance road, eight feet from the easterly edge of the right-of-way. The maintenance road lies to the east of the Bolsa Chica Channel. For most of this segment, the LAAFRC is west of the alignment, and residential uses exist east of the alignment. In the southern 600 feet of this segment, land use is residential, both east and west of the alignment. The construction methods used in this segment would be trenching, shoring, and backfilling. The alignment in this segment is located entirely within the City of Los Alamitos.

### ***Segment 4***

The alignment of this segment continues in the OCFCD right-of-way south to the I-405 freeway. The alignment crosses the east- and west-bound lanes of Lampson Avenue and continues south in the maintenance road on the east side of the Bolsa Chica Channel. The pipeline would be laid under the existing, paved maintenance road to the east of the Bolsa Chica Channel, 8 feet from the easterly edge of the right-of-way. There are residential land uses on both sides of the right-of-way. The construction methods used in this segment would be trenching, shoring, and backfilling. The alignment in this section falls within the City of Seal Beach.

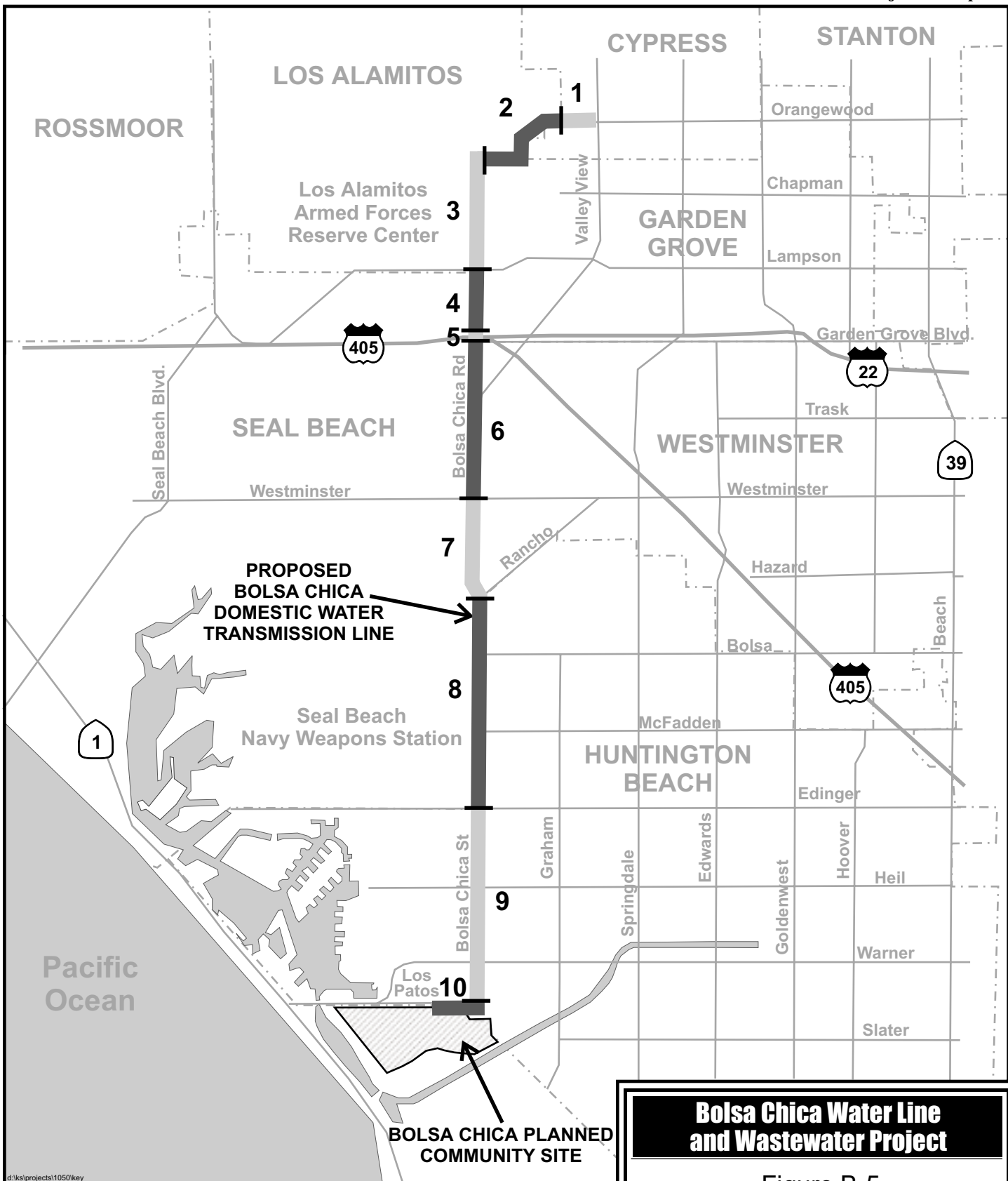

**Bolsa Chica Water Line and Wastewater Project**

Figure B-5

**Water Line Route Segments**

*Aspen*  
 Environmental Group



Note: The proposed pipeline route has been divided into ten segments for descriptive purposes only.

### ***Segment 5***

This segment is where the pipeline would cross the I-405/SR-22 freeways and associated Caltrans right-of-way. This segment is 590 feet in length and would be installed under the freeways using bore-and-jack construction methods. At the Caltrans right-of-way, the alignment turns at 90° and proceeds east for approximately 80 feet. The alignment then turns 90° and continues in a southerly direction under the freeways in an alignment that would connect with Old Bolsa Chica Road (see Segment 6 below). This segment is located within the City of Garden Grove.

### ***Segment 6***

The alignment in this 5,230-foot segment follows Old Bolsa Chica Road south from the I-405 freeway to its point of intersection with Bolsa Chica Road; and then south along Bolsa Chica Road to Westminster Avenue. The construction methods used in this segment would be trenching, shoring, and backfilling.

Immediately south of the I-405 freeway, the alignment lies in the existing right-of-way of Old Bolsa Chica Road, which is a narrow public street. The alignment is three feet east of the roadway centerline, and 27 feet from the eastern edge of the right-of-way. The Bolsa Chica Channel and the Seal Beach U.S. Naval Weapons Station are the land uses to the west of the pipeline alignment; east of the alignment are a Caltrans maintenance yard and three businesses. This street carries very little traffic. This portion of the alignment falls within the City of Seal Beach.

The alignment continues on Bolsa Chica Road south of the intersection with Old Bolsa Chica Road. At this intersection, the pipeline turns to the east from its southerly alignment, thus crossing Valley View Street. Having crossed Valley View Street, the pipeline alignment turns southwest to reach the northbound lanes on Bolsa Chica Road. From this point, the alignment continues south in the outer northbound lane in Bolsa Chica Road, 20 feet from the centerline. There is a striped median along this section of Bolsa Chica Road. The alignment gradually changes from the outer to the inner northbound lane in Bolsa Chica Road. A raised central median commences approximately 500 feet north of Westminster Boulevard and continues until the intersection. The Bolsa Chica Channel and the Seal Beach U.S. Naval Weapons Station lie to the west of the alignment; residential land uses lie to the east. This portion of the alignment falls within the City of Westminster.

### ***Segment 7***

This 3,540-foot segment begins on the northern side of the Westminster Boulevard/Bolsa Chica Road intersection and continues south on Bolsa Chica Road to the intersection with Rancho Road.

The pipeline would be bored and jacked under the Westminster Boulevard/Bolsa Chica Road intersection, a distance of approximately 100 feet. There is a raised median on both Bolsa Chica Road

and Westminster Boulevard immediately prior to the intersection. The alignment prior to and following this underground section is in the inner northbound lane, 40 feet from the centerline.

South of the intersection with Westminster Boulevard, the alignment continues south on Bolsa Chica Road for approximately 140 feet in the inner northbound lanes of Bolsa Chica Road until the U.S. Navy Railroad right-of-way is reached. There is a raised center median throughout this section. The alignment is 24 feet from the median.

The pipeline would be bored and jacked under the U.S. Navy Railroad right of way that crosses Bolsa Chica Road (a distance of 120 feet). The alignment remains in the inner northbound lanes of Bolsa Chica Road. There is a raised center median either side of the railway line.

Following the Navy railway right of way, the pipeline would again be constructed by open trenching and would resume the earlier alignment in the inner northbound lanes of Bolsa Chica Road. Approximately 200 feet south of the right of way, the alignment changes to the outer northbound lane, 50 feet from the centerline, eight feet from the curb. There is a striped center median at this stage.

This alignment is maintained until approximately 80 feet north of Hampton Court, where the alignment shifts into the inner lane, 20 feet from the centerline and six feet from the striped center median. This alignment is maintained for approximately 300 feet, before returning to the original alignment south of Hampton Court. The alignment remains in the outer lane until the Anaheim-Barber City Channel and Rancho Road are reached.

The Anaheim-Barber City Channel is crossed by connecting the pipeline to a reinforced concrete box culvert, in the OCFCD right of way. The pipeline will be attached to the parapet on the upstream side of the culvert. The pipeline, which will be above ground over the crossing, will be an 18-inch cement-lined welded steel pipe (.375 inches thick) and will be attached to the center rail of the guard rail.

The Rancho Road – Bolsa Chica Road intersection would be crossed using the open trenching method. The crossing of this intersection would begin in Rancho Road, approximately 10 feet from the intersection with Bolsa Chica Road. The alignment requires approximately 20 feet of trenching in the southbound lanes of Rancho Road, before the alignment turns south into Bolsa Chica Road to cross the intersection.

This segment falls within the City of Westminster.

### ***Segment 8***

This 7,600-foot segment begins on the southern edge of the Bolsa Chica Street – Rancho Road intersection and continues in a southerly alignment along Bolsa Chica Street to Edinger Avenue.

The alignment is in the outer northbound lane of Bolsa Chica Street for 160 feet south of the Rancho Road intersection. At this intersection it switches to the inner northbound lane, approximately four feet from the raised center median. It maintains the alignment until Edinger Avenue is reached, passing the termini of Bolsa Avenue, Tasman Drive, McFadden Avenue, Dovewood Drive and Robinwood Drive.

Upon reaching the Westminster Channel to the immediate north of Edinger Avenue, the pipeline would cross the channel on the easterly edge of the existing road bridge using a single-span support structure.

The Edinger Avenue – Bolsa Chica Street intersection would be crossed using the trenching method. The crossing of this intersection would begin in Edinger Avenue, approximately 20 feet from the intersection with Bolsa Chica Street. The alignment requires trenching across both the east and westbound lanes of Edinger Avenue, before the alignment returns to Bolsa Chica Street and continues south.

This segment falls within the City of Huntington Beach.

### ***Segment 9***

The alignment in this 6,600-foot segment continues south on Bolsa Chica Street, across Warner Avenue to Los Patos Avenue. South of the Edinger Avenue intersection, the alignment is in the outer northbound lane, 33 feet from the centerline. There is a raised central median throughout much of this segment. This alignment is maintained until immediately prior to Heil Avenue. At this point, the alignment switches to the inner northbound lane, three feet from the centerline. The pipeline crosses Heil Avenue in this alignment and maintains it until 200 feet north of Warner Avenue.

At this point, north of Warner Avenue, the alignment moves to the outer northbound lane, 38 feet from the centerline. It crosses Warner Avenue on this alignment.

South of Warner Avenue, Bolsa Chica Street narrows as most of the traffic turns onto Warner Avenue, a high traffic-volume street. The alignment moves to the southbound lane, 31.5 feet to the west of the centerline and 18 feet from the western curb. This alignment is maintained until Los Patos Avenue is reached.

This segment falls within the City of Huntington Beach. Open trenching is used throughout this segment.

### ***Segment 10***

This segment is located on the private property of the Bolsa Chica Planned Community site. The pipeline would be located immediately adjacent to the northern boundary of the proposed residential development site, paralleling the southern edge of the Los Patos Avenue right-of-way. The pipeline

would lie a few feet south of Los Patos Avenue, approximately 30 feet south of the centerline. The alignment along this 1,300-foot segment is in a ten-foot pipeline easement provided for this purpose. The construction methods used in this segment would be trenching, shoring, and backfilling.

This segment falls within the City of Huntington Beach and the County of Orange.

### **B.6.2 ON-SITE WATER FACILITIES**

In order to provide water storage and distribute water to the proposed residential units of the Bolsa Planned Community project, an underground water storage reservoir, a pump station, a groundwater well and treatment plant, and a backbone distribution system would be constructed on Bolsa Chica Mesa. A diagram of the proposed water facilities to be constructed on the Bolsa Chica Planned Community site is presented in Figure B-6. These and other on-site facilities were previously subject to environmental review in the *1996 Recirculated Draft Environmental Impact Report for the Bolsa Chica Report Local Coastal Program*. Information on these facilities is presented here solely to provide the reader with an understanding of related water facilities required to provide water service to the Bolsa Chica Planned Community project. These previously studied facilities are not re-examined in this Supplemental EIR.

**Underground Reservoir.** The proposed water transmission line would terminate at an underground reservoir on Bolsa Chica Mesa. The reservoir has a planned capacity of 4.0 million gallons (MG). The proposed location of the reservoir is just to the south of Los Patos Avenue, midway between Marina View Place and Bolsa Chica Street, south of the intersection of Los Patos Avenue and Lynn Street. According to SCWC, the following factors were pertinent to the siting decision, including:

- Construction and maintenance access provided by Los Patos Avenue
- Minimal grading required prior to construction of the reservoir and related facilities
- This location has the highest elevation in the project area, thus maximizing hydraulic benefits
- Distance from the Newport-Inglewood Fault, thus mitigating structural design and construction costs
- Proximity to the Los Patos Avenue – Bolsa Chica intersection, the primary water source (SCWC 1998c, p. 3-10).

The proposed reservoir is a cylindrical concrete tank approximately 35 feet deep. Approximately 40 feet of excavation will be required to account for two to three feet of earth cover for a maintenance yard and proposed community park (Tetra Tech, 1999, p. 2). A site plan for the reservoir site is displayed in Figure B-7.



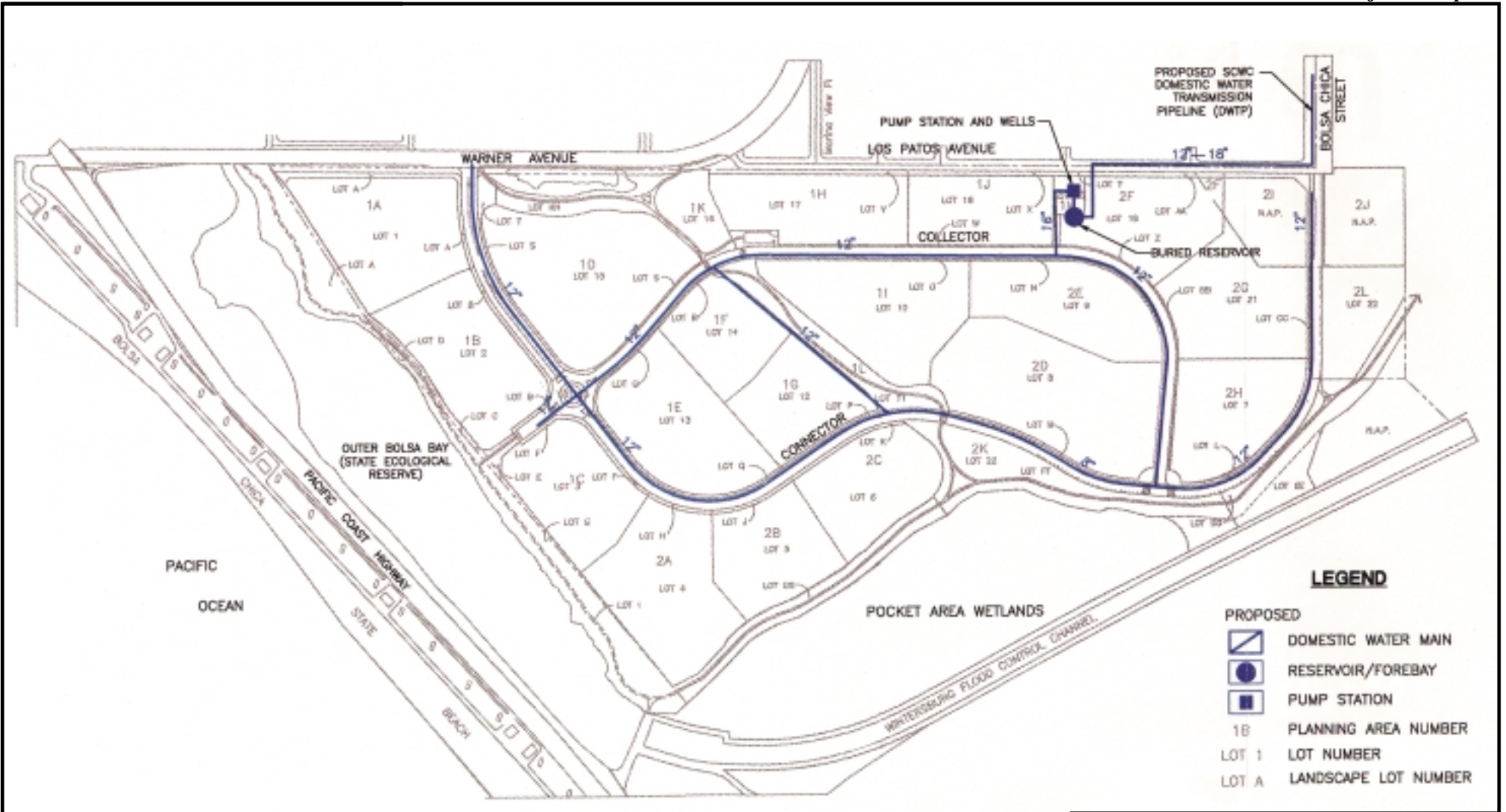

**LEGEND**

PROPOSED

- DOMESTIC WATER MAIN
- RESERVOIR/FOREBAY
- PUMP STATION
- 1B PLANNING AREA NUMBER
- LOT 1 LOT NUMBER
- LOT A LANDSCAPE LOT NUMBER

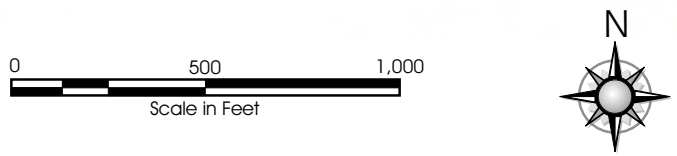

**Bolsa Chica Water Line and Wastewater Project**

Figure B-6  
**Proposed Onsite Water Storage and Distribution Facilities**

**Aspen**  
 Environmental Group

Note: Except for the SCWC water transmission line, the water facilities illustrated in this diagram were part of the project evaluated in the 1996 Recirculated Draft EIR for the Bolsa Chica Report Local Coastal Program.

Source: Plan of Works prepared by IWA Engineers, 1998

SCWC's storage criteria require capacity sufficient to meet the greater of: peak hour demand, or maximum day demand plus fire flow. For the Bolsa Chica Planned Community project, the reservoir has been designed to provide a capacity greater than the maximum day demand plus fire flow. Based on the Plan of Works report, maximum day demand is 1,405 gpm and maximum day demand plus fire flow is 4,405 gpm. The capacity of the reservoir was sized to be either 4.0 MG without on-site wells or 2.0 MG with on-site wells. Additional data on the reservoir sizing may be found in The Plan of Works Report for Water and Wastewater (IWA Engineers, 1998).

SCWC's storage criteria for emergencies require that the reservoir has sufficient redundancy to meet the maximum day demand with the largest source of supply (in this case the SCWC transmission line) out of service.

The reservoir (4.0 MG) can be filled in 41 hours at a rate of 1,632 gpm. Once filled, the operating range would be limited to a single maximum day demand (2.35 MG), i.e., the amount that can be replenished in a 24-hour period. The reservoir would include two internal reservoirs in order for one reservoir to be in operation while the other is out of service. An emergency generator would provide power to water facilities in the event that power is lost to the booster pumps, well and treatment facility (SCWC, 1999a, p. 13).

A pressure-activated inlet valve will control the volume and flow rate of water entering the reservoir. The purpose of the valve would be to maintain the water level in the reservoir within pre-set limits. The valve's operation may be controlled by a combination of parameters such as the current reservoir water level, the rate of change of the water level, time of day and time of year (Tetra Tech, 1999, p. 4).

**Distribution System Pumps.** An aboveground structure adjacent to the underground concrete reservoir would house the distribution system pumps and other equipment including pump controls, on-site well equipment and an emergency generator for back-up power. The pumps would be used to pump water from the underground storage reservoir into the on-site distribution system. The pumps and piping would deliver water at a maximum pressure of 80 pounds per square inch (psi); minimum pressures would be 20 psi for fire flow and maximum day demand, 40 psi for peak hour demand and 20 psi for inflow to the reservoir. The booster pump station must be capable of delivering 2,312 gpm for peak hour and 4,405 gpm for maximum day plus fire flow. Since the proposed residential development is relatively small, the pump must be capable of maintaining system pressure during 'low flow' conditions. To meet this requirement, four 1,100-gpm pumps and one 300-gpm jockey pump would be needed. A standby 1,100-gpm pump is also required. The larger pumps would be powered by 75-horsepower (hp) motors and the jockey pump would be driven by a 20-hp motor.

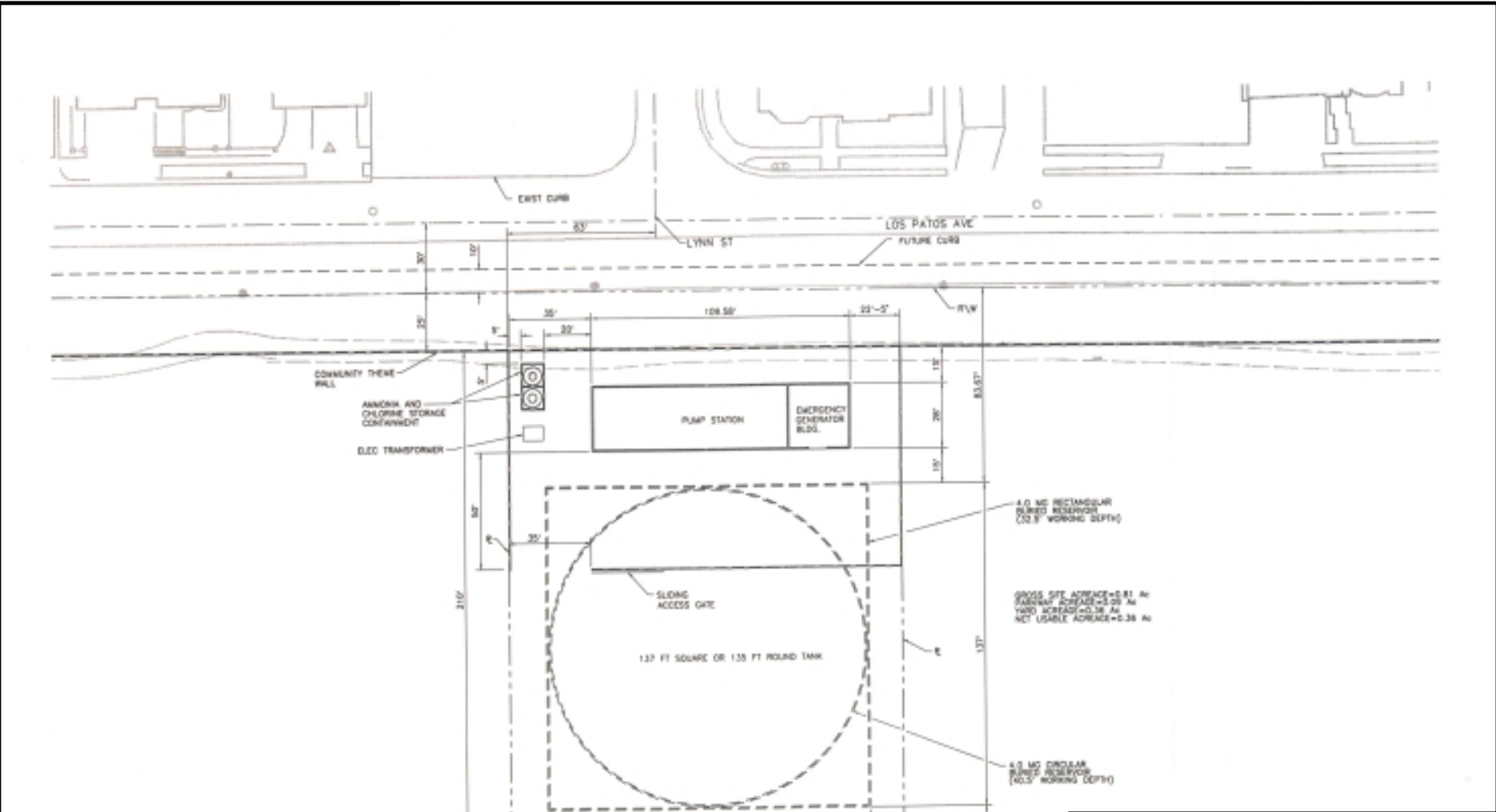

**Bolsa Chica Water Line and Wastewater Project**

Figure B-7  
**Onsite Underground Reservoir Site Plan**

*Aspen*  
 Environmental Group

Source: Plan of Works prepared by IWA Engineers, 1998

**Groundwater Well.** The on-site water system for the Bolsa Chica Planned Community project has been designed to include backup water sources to ensure reliability (SCWC, 1999a, p. 6) and to reduce the required size of the on-site reservoir (Tetra Tech, 1999, p. 2). The groundwater well would pump water from anticipated depths of 800 to 1000 feet. A test well was drilled to enable analysis of subsurface materials and water quality. These tests showed that two 1,100-gpm wells could be constructed on site and that water quality was satisfactory, although it exhibited a high color index (Tetra Tech, 1999, p. 2). The groundwater would be pumped into the on-site reservoir, following treatment. It is expected that the well would yield a maximum of 1,100 gallons per minute for a maximum daily production of 1.58 million gallons per day. It is estimated that the maximum annual draw on the groundwater basin would be 750 acre-feet per year. The groundwater well would be controlled by equipment installed for the pump station facility.

**Interconnections.** It is usual for interconnections between neighboring water systems to be established to ensure reliability of supply in case of emergency. SCWC is pursuing interconnections with cities along the route of the proposed pipeline, such as the cities of Westminster, Seal Beach, and Huntington Beach (SCWC, 1999a, p. 12). If a problem with the pipeline occurs, these interconnections would allow continuity of service.

**Wellhead Treatment.** A treatment facility would be established at the wellhead. Nano-filtration would be used to remove particulates and organic matter while *chloramination*, utilizing ammonia and chlorine, would be used to disinfect the water prior to storage in the reservoir. The chemicals would be stored in a purpose-built facility on site.

**Distribution Lines.** A distribution system would be developed on site to provide water service to individual homes. A backbone distribution system, consisting of 8-, 12-, and 16-inch diameter pipes would be laid under the proposed streets of the residential development.

### **B.6.3 WASTEWATER COLLECTION FACILITIES**

Hearthside Homes, Inc., has entered into an agreement with SCWC for operation and maintenance of the sewer system for the Bolsa Chica Planned Community. The sewer system facilities proposed for the project include on-site sewage collection lines, a sewage lift station (to be operated by SCWC), and a sewer force main (also to be operated by SCWC). All sewage generated by the development would flow by gravity to the proposed sewage lift station where it would be pumped to the existing Orange County Sanitation District (OCS D) 21-inch trunk sewer located in Los Patos Avenue. SCWC would own, operate, and maintain the sewer collection system at the Bolsa Chica Planned Community site. Residents of the development would be charged \$6.00 per month or \$0.267 per one hundred cubic feet of water used, whichever is greater.

The components of the system are described below and their locations are shown in Figure B-8. The description of the proposed wastewater facilities is based upon descriptions provided in the Plan of

Works submitted by SCWC in support of its application for a Certificate of Public Convenience and Necessity. In turn, this material is based upon a project description provided by the proponent of the Bolsa Chica Planned Community, Hearthside Homes, Inc. At the time of writing, the California Coastal Commission was considering the LCP in the light of the Appellate Court's finding that the eucalyptus grove cannot be removed as previously proposed. The final configuration of development on the Mesa and, more particularly, the final number of dwelling units, may therefore be subject to change.

**Proposed Collection System.** A backbone sewer system, consisting of 8-, 12-, 15- and 18-inch diameter sewer lines and a 6-inch force main, would be constructed under the streets in the proposed residential development. The location criteria used for sewer facilities would be based on City of Huntington Beach standards, with collector sewers placed within proposed streets or through open space areas as required. The sewers would be buried at a minimum depth of six feet.

The length of the sewers would be as follows:

- 4,370 linear feet of 8-inch sewer
- 7,210 linear feet of 12-inch sewer
- 1,770 linear feet of 15-inch sewer
- 1,520 feet of 18-inch sewer.

The estimated average day wastewater flow generated by the proposed development is 0.51 million gallons per day (mgd); the peak hour wastewater flow generated is estimated to be 1.53 mgd. Peak hour flows were used to size the sewers and lift station to be used in the system.

**Lift Station.** A sewage lift station would be constructed immediately south of Warner Avenue, near the intersection with Los Patos Avenue. A site plan for the lift station is displayed in Figure B-9. The lift station will use two 50-hp pumps with a capacity of 1200 gpm each (SCWC, 1998c, p. 4-7).

**Force Main.** An 875-foot force main would be located on Los Patos Avenue between the proposed sewage lift station and the existing 21-inch OCSD trunk sewer in the same street. The force main would transport wastewater at a velocity of 3 to 6 feet per second (fps) to the existing gravity-fed trunk sewer in Los Patos Avenue which would, in turn, transport the wastewater into the existing OCSD collection, treatment and disposal system.

**Emergency Systems.** The design of the wastewater system includes measures to avoid failure of the wastewater lift station and potential sewage overflows. The sewage lift station would have three pumps; two for normal operation and a third for backup in case of pump failure. Pump usage would be rotated to assist maintenance and reduce the possibility of pump failure. The wet well and inflow gravity sewer

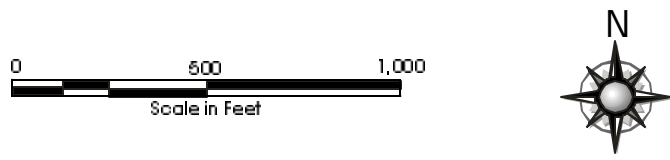
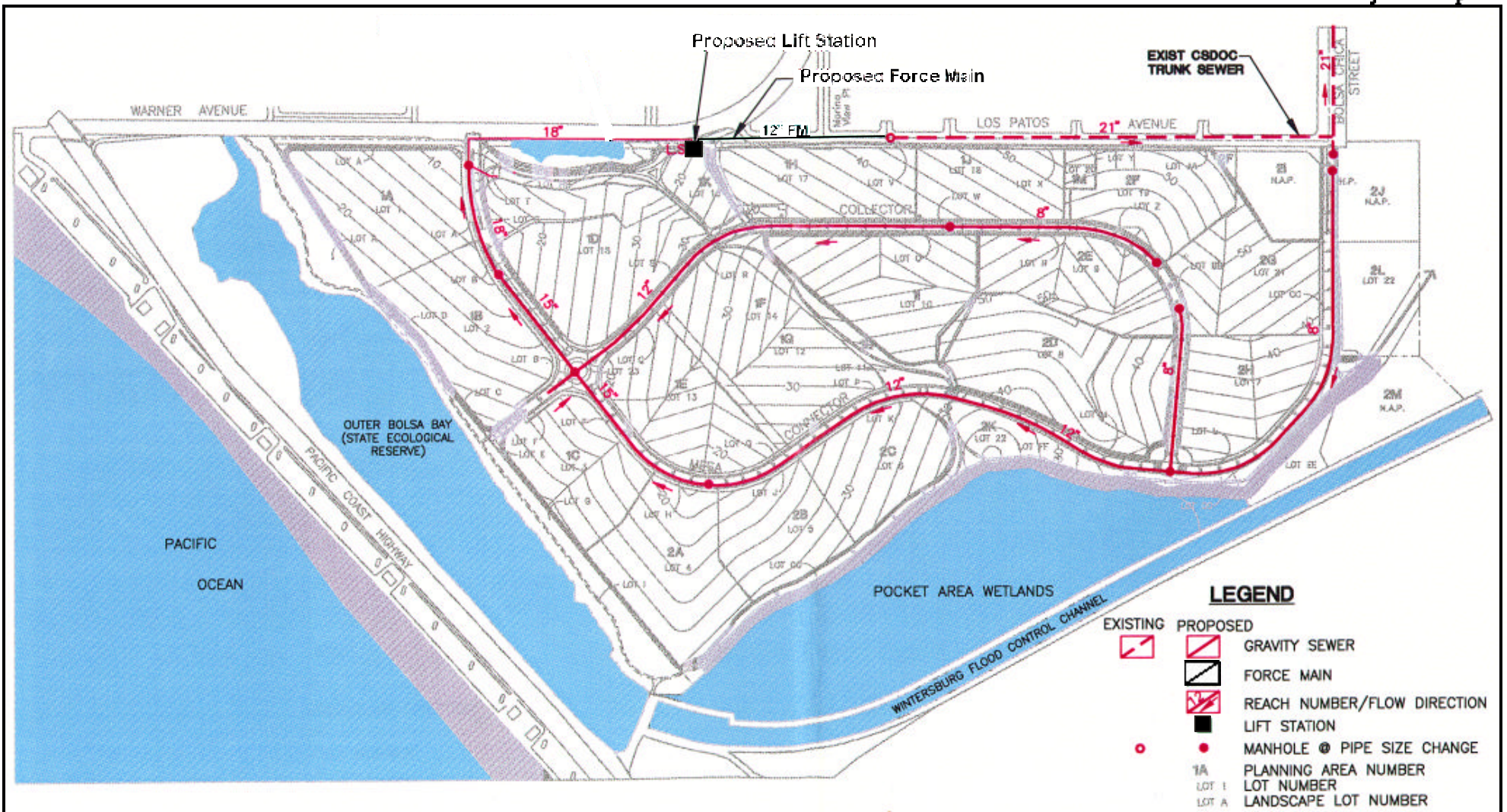

**Bolsa Chica Water Line and Wastewater Project**

Figure B-8  
**Proposed Wastewater Collection Facilities**

**Aspen**  
 Environmental Group

Note: The wastewater facilities illustrated in this diagram were part of the project evaluated in the 1996 Recirculated Draft EIR for the Bolsa Chica Report Local Coastal Program.

Source: Plan of Works prepared by IWA Engineers, 1998. Revised February 2000.

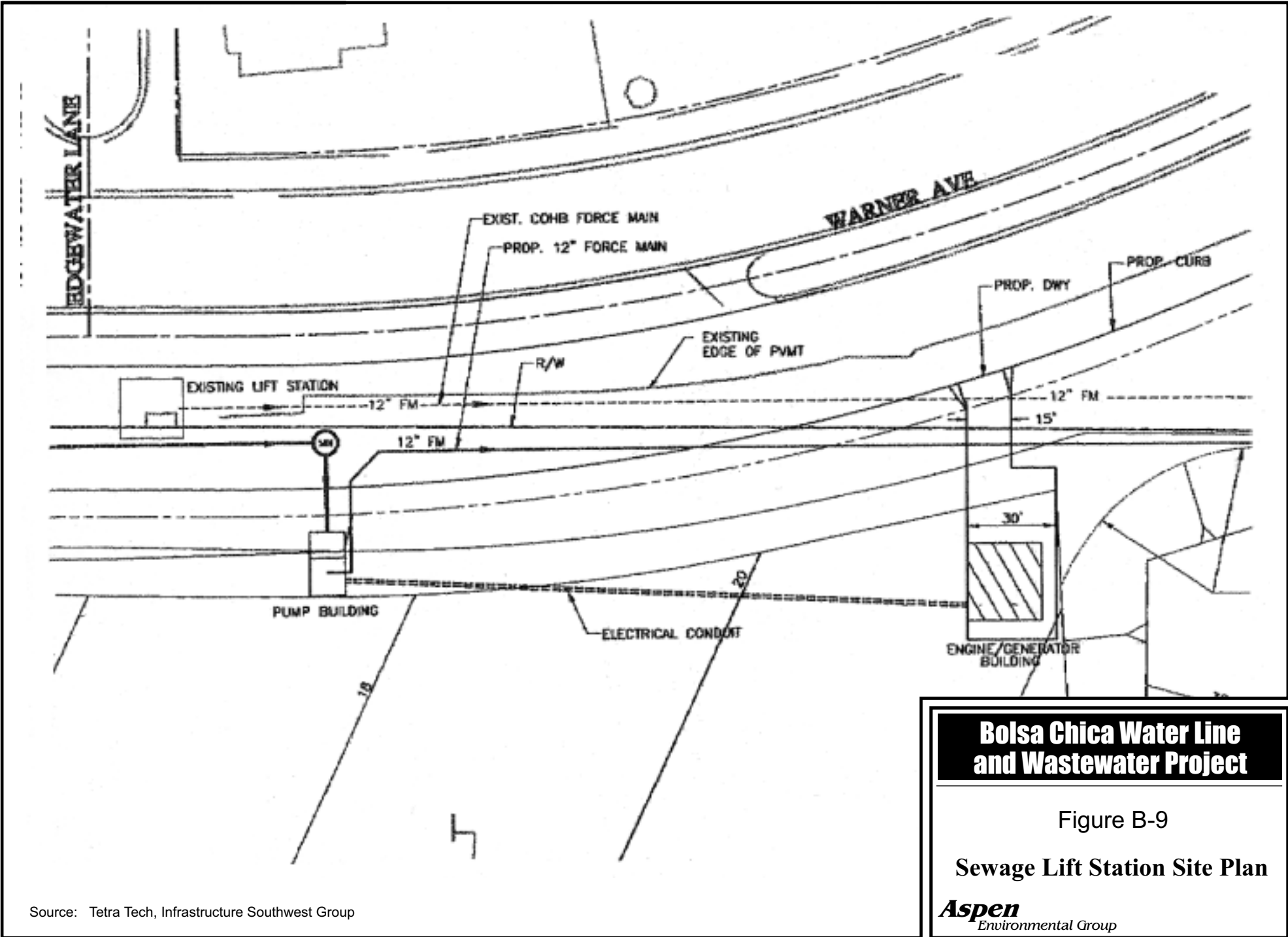

**Bolsa Chica Water Line  
and Wastewater Project**

Figure B-9  
**Sewage Lift Station Site Plan**

**Aspen**  
Environmental Group

Source: Tetra Tech, Infrastructure Southwest Group

would be sized with sufficient capacity to store about two hours of average sewage flow during a pump failure or loss of power. In cases of a loss of power, a manual electrical transfer switch and emergency connection would be provided so that a truck-mounted portable generator can be quickly utilized.

Bypass piping and emergency connections between the wet well and the sewer force main are included in the design so that emergency pumps can be used to pump around the lift station to the force main. Finally, alarms at the lift station would be transmitted to the 24-hour Customer Service Center for emergency response (SCWC, 1999a, p. 14).

**OCSD System.** The proposed water line would be located within the Orange County Sanitation District (OCSD) Revenue Areas 3 and 11. In order for the development to receive sewage collection and disposal services, annexation into the district is required. A pre-annexation agreement has been executed between the landowner (Signal Landmark) and the OCSD, and final annexation of the property into Districts 3 and 11 can occur after the development receives all of its approvals.

Wastewater flows from the residential development project would be transported through the OCSD Slater Avenue Pump Station and sewer system. The Sanitation District expanded these facilities in 1995 to include flows generated by the proposed Bolsa Chica Planned Community. Wastewater generated by the project would be treated at the OCSD's Plant 2 in Huntington Beach. This treatment plant has the available capacity to serve the proposed residential development (SCWC, 1999a, p. 7).

## **B.7 PROJECT CONSTRUCTION**

### **B.7.1 DOMESTIC WATER TRANSMISSION LINE**

This section describes how the domestic water transmission line would be constructed for the proposed project. It is assumed that the same construction method would be used for the alternatives described in Section D as well.

**Schedule.** Pending all permits, approvals, and the current Bolsa Chica development schedule, project construction would commence in 2000. It is anticipated that construction would progress at an average rate of 100 feet per day along three concurrent construction spreads (SCWC, 1999b, p. 3-8). Each construction spread would operate on a separate section of the pipeline route. The three sections of the pipeline route where construction would occur concurrently are shown in Figure B-10. According to the Plans of Works Report for Water and Wastewater, the construction of the proposed pipeline would take approximately 180 to 250 days to complete [SCWC, 1998c, p. 5-7 (Figure 5.1)]. Table B.7-1 provides a description of the construction schedule for the three construction sections. Work hours for construction of the pipeline would be Monday through Friday between the hours of 7:00 a.m. and 6:00 p.m. No construction would occur on Saturday or Sunday (SCWC, 1999b, p. 3-11).



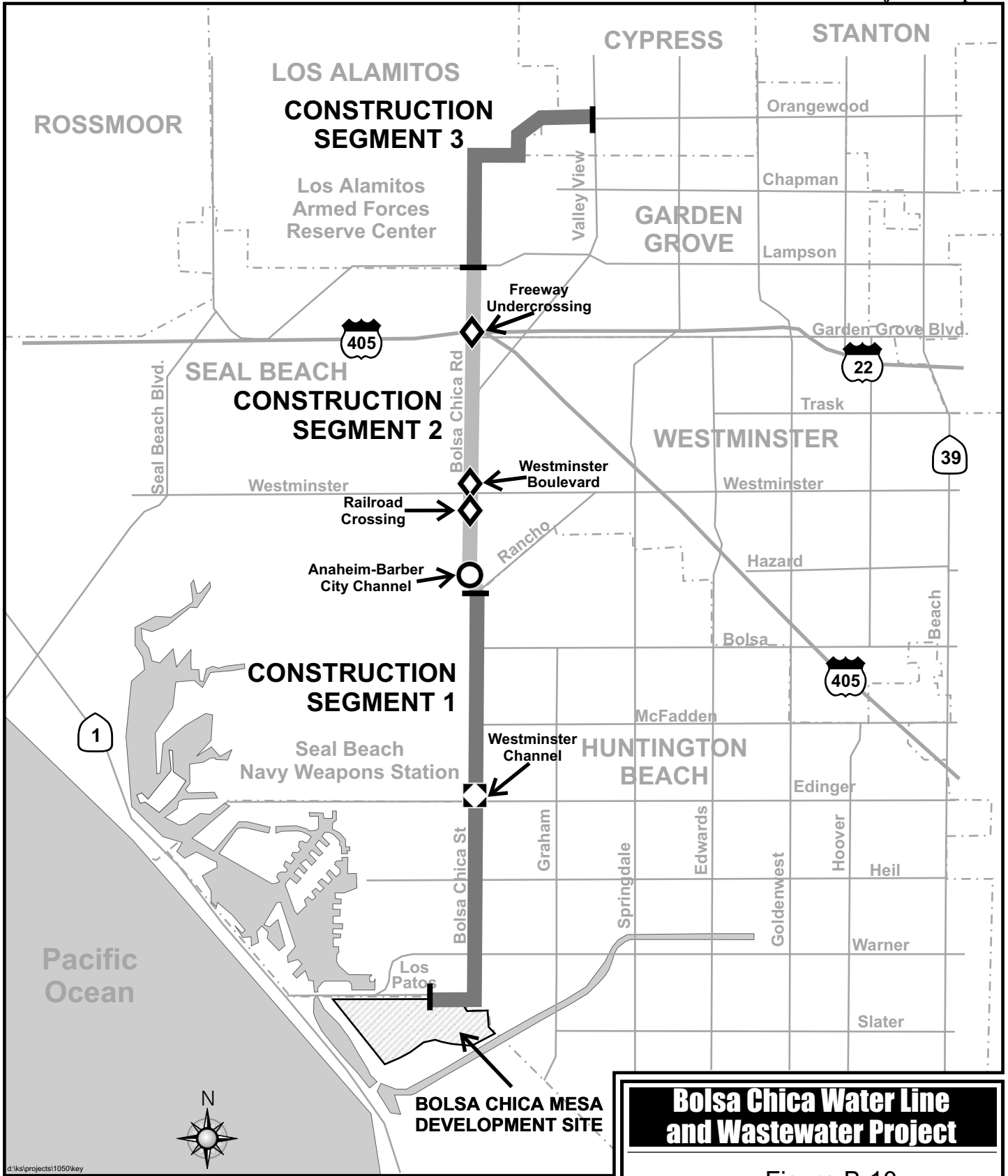

**Bolsa Chica Water Line and Wastewater Project**

Figure B-10

**Construction Segment Map**

*Aspen*  
 Environmental Group

d:\ks\projects\11050\key

- ◆ Bore and Jack
- Concrete Culvert Attachment
- ◻ Single-span Support Structure

Note: Pipeline construction would occur concurrently along each of the three construction segments.

0  1 1/2

Scale in Miles

**Labor Force.** Approximately 20 personnel would be employed for pipeline construction (SCWC, 1999b, p. 4-16). Approximately 60 percent of the workforce would be skilled, and 40 percent unskilled labor with a majority of the work force likely originating in southern California, mainly from the Los Angeles Basin. It is expected that most laborers would meet in a staging yard and go to the construction site in the work trucks and pick-up trucks.

**Schedule.** Pending all permits, approvals, and the current Bolsa Chica development schedule, project construction would commence in 2000. It is anticipated that construction would progress at an average rate of 100 feet per day along three concurrent construction spreads (SCWC, 1999b, p. 3-8). Each construction spread would operate on a separate section of the pipeline route. The three sections of the pipeline route where construction would occur concurrently are shown in Figure B-10. According to the Plans of Works Report for Water and Wastewater, the construction of the proposed pipeline would take approximately 180 to 250 days to complete [SCWC, 1998c, p. 5-7 (Figure 5.1)]. Table B.7-1 provides a description of the construction schedule for the three construction sections. Work hours for construction of the pipeline would be Monday through Friday between the hours of 7:00 a.m. and 6:00 p.m. No construction would occur on Saturday or Sunday (SCWC, 1999b, p. 3-11).

**Table B.7-1 Pipeline Construction Schedule**

Construction Phase/Section	Linear Feet	Progress Rate (ft/day)	Days	Construction Months										
				1	2	3	4	5	6	7	8	9		
Setup	NA	NA	10											
Section 1 - Los Patos Avenue to Westminster Channel Crossing	15,400	100	154											
Section 2 - Westminster Channel Crossing to Bolsa Chica Maintenance Road	11,400	100	114											
Section 3 - Bolsa Chica Maintenance Road to Orangetown Avenue	8,700	100	87											
Three Bores	NA	NA	NA											
Clean Up	NA	NA	NA											

**Labor Force.** Approximately 20 personnel would be employed for pipeline construction (SCWC, 1999b, p. 4-16). Approximately 60 percent of the workforce would be skilled, and 40 percent unskilled labor with a majority of the work force likely originating in southern California, mainly from the Los Angeles Basin. It is expected that most laborers would meet in a staging yard and go to the construction site in the work trucks and pick-up trucks.

**Equipment and Material.** The equipment estimated for pipeline construction is in Table B.7-2. These estimates are representative of the type of construction equipment to be used on this project. SCWC has

indicated that all construction equipment would be fitted with appropriate mufflers and all engines would be maintained regularly.

**Table B.7-2 Equipment Inventory**

Equipment	Number	Days	Hours/Day
<b>Section 1 - Los Patos Avenue to Westminster Channel Crossing</b>			
<i>Diesel:</i>			
Asphalt/Concrete Saw	1	4 - 5	8
Backhoe Loader	1	140 - 160	8
Excavator	1	140 - 160	8
Compactor Roller	1	140 - 160	2
Asphalt Paver	1	140 - 160	2
<i>Gasoline:</i>			
Pickup Truck	2	140 - 160	10
<b>Section 2 - Westminster Channel Crossing to Bolsa Chica Maintenance Rd</b>			
<i>Diesel:</i>			
Asphalt/Concrete Saw	1	4 - 5	8
Backhoe Loader	1	100 - 120	8
Excavator	1	100 - 120	8
Compactor Roller	1	100 - 120	2
Asphalt Paver	1	100 - 120	2
<i>Gasoline:</i>			
Pickup Truck	2	100 - 120	10
<b>Section 3 - Bolsa Chica Maintenance Road to Orangewood Avenue</b>			
<i>Diesel:</i>			
Asphalt/Concrete Saw	1	4 - 5	8
Backhoe Loader	1	80 - 100	8
Excavator	1	80 - 100	8
Compactor Roller	1	80 - 100	2
Asphalt Paver	1	80 - 100	2
<i>Gasoline:</i>			
Pickup Truck	2	80 - 100	10
<b>Three Bores - Equipment Inventory</b>			
<i>Diesel:</i>			
Asphalt/Concrete Saw	4	5 - 10	8
Backhoe Loader	3	3 - 5	8
Excavator	3	4 - 7	8
Compactor Roller	3	5 - 10	8
<i>Gasoline:</i>			
Pickup Truck	2	10 - 20	10

**Staging and Storage Areas.** For open-trench pipeline construction, the project specifications would not allow the pipeline contractor to store equipment or supplies other than those that are necessary for the work performed each day. Therefore, it is not anticipated there would be staging areas during construction of the pipeline. The only exception is the storing of supplies and equipment for boring and jacking operations within the specified work area limits for those operations. The work area limits for boring and jacking operations are indicated on the construction plans and are not to be used as “staging areas” for other construction activities.

**Utility and Service Requirements.** Construction equipment would require both gasoline and diesel fuel. Equipment would be refueled primarily onsite using mobile fuel trucks. Project construction would require little demand for electrical power; where needed, generators would be used at the construction sites for power. Construction activities would not require natural gas or fixed telephone service. Generally, most of the communication would be through mobile phone service.

Water would be used as necessary to control fugitive dust and to wash streets as a supplement to sweeping streets. In addition to the daily construction water needs, hydrostatic testing of the pipeline would also require water. Water would be obtained from local water sources.

**Pipeline Construction Methods within the Right-of-Way.** A pipeline construction spread would be composed of several units. The units would be organized to proceed with the work in the order listed below. A typical construction spread is illustrated in Figure B-11. The various pipeline construction activities are generally described in the following sections:

- Pre-construction Activity
- Trenching
- Pipe Handling and Laying
- Backfilling and Compaction
- Resurfacing/Restoration.

The alignment for this proposed pipeline would be located in existing paved streets or utility rights-of-way (ROWs) except at waterway crossings, railroad crossings, and highway crossings. Since the pipeline construction ROW is located within major road corridors, construction would require closure of at least one lane of traffic to accommodate the construction ROW. Approval to construct and operate a pipeline would be obtained or authorized by franchise agreements or permits from the agency with jurisdiction over the streets along the proposed route.

**Pre-construction Activity.** After the ROW is obtained and the project is permitted, landowners, permittees, and business owners along the ROW would be notified in advance of construction activities that could affect their business or operations. Notification to landowners would be by mail. Tenants would be notified in person a few days ahead of construction.

Emergency response providers near the proposed route would also be notified in advance of construction locations, road closure schedules, and potential alternate routes. SCWC would work with local police and traffic engineers to plan appropriate access alternatives for temporary street closures and traffic disruptions. Traffic control requirements from municipalities would also be followed.

Prior to construction, SCWC would notify Underground Service Alert (USA), which would notify service providers of the intended construction to avoid conflict with existing utilities and disruptions of service to utility customers.

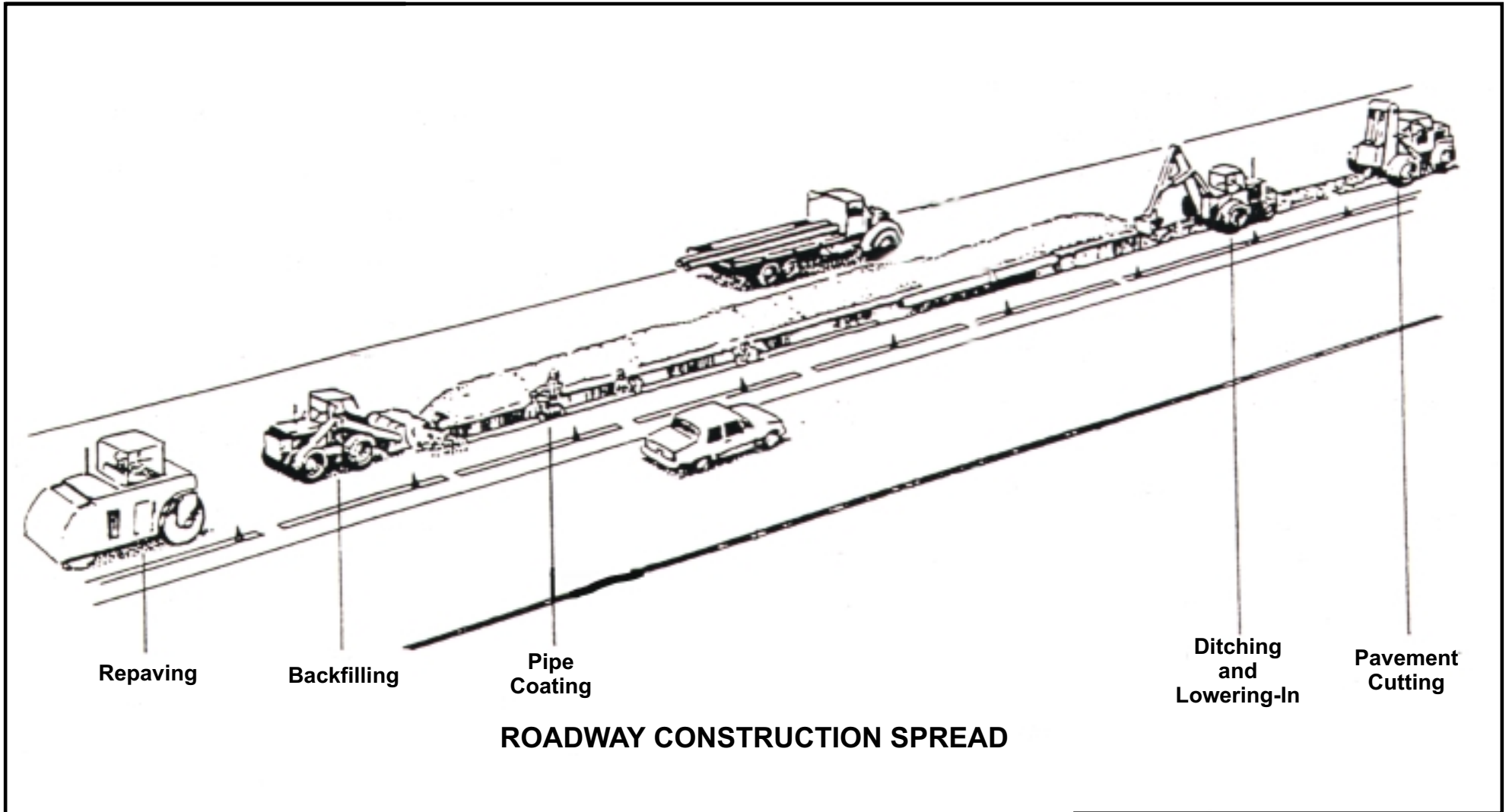

Repaving

Backfilling

Pipe  
Coating

Ditching  
and  
Lowering-In

Pavement  
Cutting

**ROADWAY CONSTRUCTION SPREAD**

**Bolsa Chica Water Line  
and Wastewater Project**

Figure B-11  
**Pipeline Construction Diagram  
(Typical)**

**Aspen**  
Environmental Group

Since construction would occur almost exclusively in paved streets, no extensive grading is proposed. Other than a truss across Westminster Channel, no construction of roads and bridges is anticipated. Surface preparation would include breaking and removing pavement with concrete saws, pavement breakers, and where necessary, jack hammers. The broken debris would be hauled off to approved landfill sites or a crusher plant via dump trucks.

**Trenching.** Once traffic control measures are in place, ditching operations would begin. Typically, a five-foot-deep ditch would be excavated (varying depending on the conditions encountered), and a typical trench would be four feet wide (SCWC, 1999b, p. 3-7). The total work area would typically be approximately 20 to 25 feet in width (SCWC, 1999b, p. 3-7). The ditch would be excavated using backhoes or excavators. An exception to the mechanical excavation would be hand-digging to locate buried utilities, such as other pipelines, cables, water mains and sewers. No blasting is anticipated. A cross-section view of a typical pipeline trench is displayed in Figure B-12.

The length of the excavated trench is typically the distance necessary to accommodate the amount of pipe installed in a single day. For the Proposed Project, pipe installation would progress along the alignment at an advancement rate of about 100 feet per day along each of the three construction spreads (SCWC, 1999b, p. 3-8).

As the trench is excavated, the trench walls would be supported or shored with hydraulic jacks or trench boxes (SCWC, 1999b, p. 3-9). Steel or wood sheeting between H-beams would be occasionally used. Other similar shoring methods may be used. Trenches greater than five feet deep require shoring to prevent the sides from caving in or collapsing as required by Cal-OSHA. Shoring is also required when a sloped back excavation would extend into the influence zone of an existing structure. All shoring would be done in accordance with Cal-OSHA and SCWC's safety requirements.

Spoils from cuts would typically be used as backfill materials at the site of origin. Materials unsuitable for backfill use and economically not usable for other purposes would be disposed of in accordance with local and county guidelines in available landfills.

For portions of the alignment that are constructed in areas with high groundwater, the groundwater level must be lowered prior to, and during, the excavation of the trenches. It is possible that groundwater would be encountered during excavations for the pipeline. If dewatering is necessary, a National Pollutant Discharge Elimination System (NPDES) permit would be required and the discharge must meet the specifications and requirements of the Regional Water Quality Control Board (RWQCB). A more detailed assessment of the occurrence of groundwater along the pipeline route is planned as part of the final design. All applicable regulations regarding the disposal of groundwater, if encountered, will need to be followed. Since high groundwater was not encountered during previously performed geotechnical investigations, it is expected that only limited dewatering will be necessary.

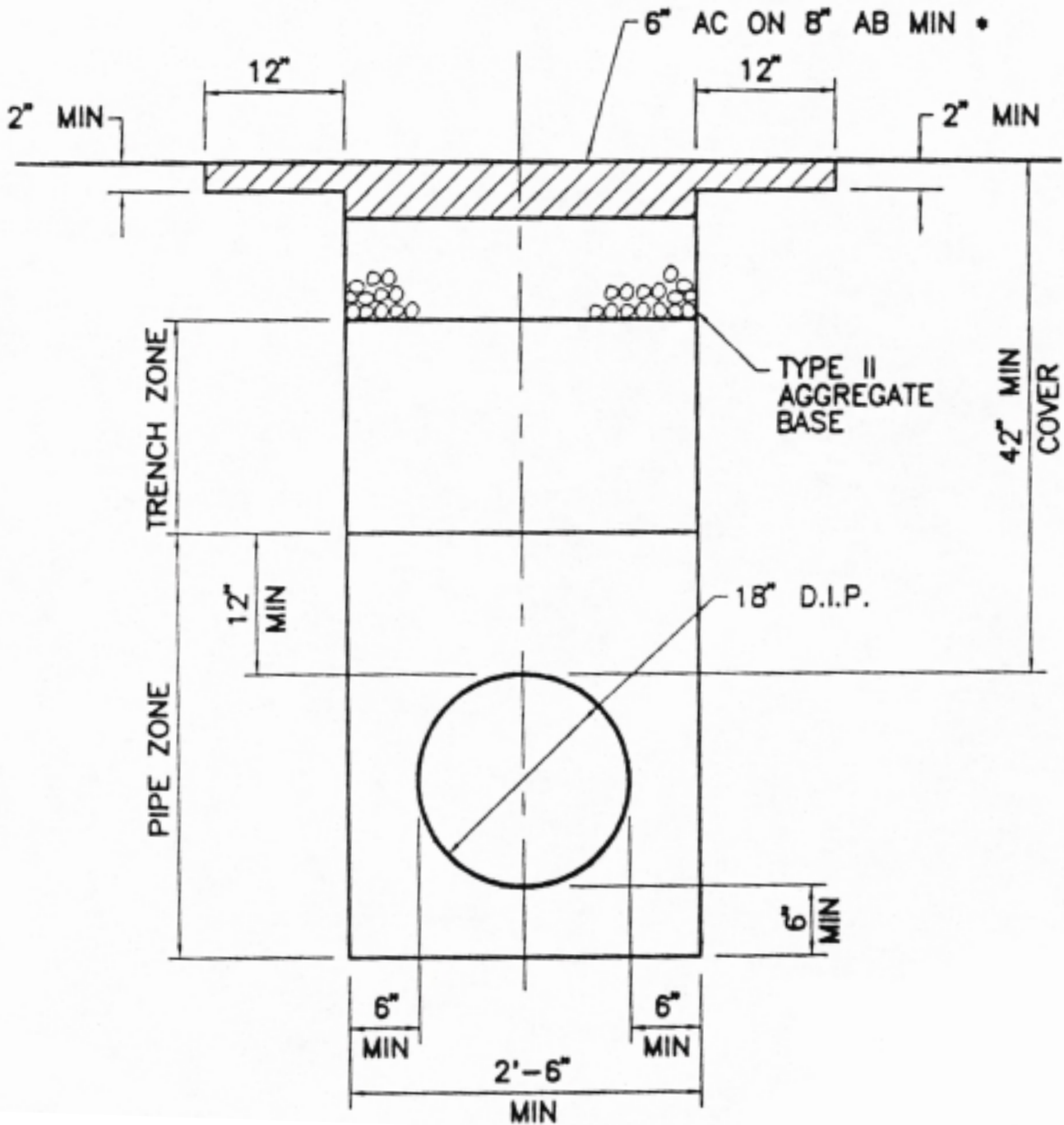

• NOTE  
 A.C. MUST BE EXIST  
 A.C. THICKNESS PLUS 1"

**Bolsa Chica Water Line  
 and Wastewater Project**

Figure B-12  
 Typical Pipeline  
 Trenching/Bedding  
 Diagram

**Aspen**  
 Environmental Group

Source: SCWC, 1997, Construction Plans for the Bolsa Chica  
 18" Water Transmission Main

**Pipe Handling and Laying.** Typically, 18-inch waterline construction does not require specialized equipment to move the pipe from the haul truck to the ditch. The equipment used will be at the discretion of the contractor based on constraints such as overall project schedule, working hours and work area restrictions.

The installation of the pipeline involves the placement of a bedding material in the bottom of the trench prior to laying the pipe. The bedding material provides a superior support for the pipe and usually consists of imported gravel, sand, or other aggregate. Where soil conditions permit, the excavated soil can be used as the bedding. For the Proposed Project, site material will not be suitable for bedding, but can be used as backfill above the bedding material, as long as it is free of organic material, contamination, and debris.

The bedding material is placed in the trench, spread, compacted to a predetermined thickness, and formed to fit the pipe joints before the pipe is placed in position. Other pipe support methods may be employed depending on soil conditions, pipe size, and depth. Once the bedding material is in place, a segment of pipe is placed in the proper position on the bedding with a crane, backhoe, or manually. The next pipe segment is placed in position and the joint sealed to prevent leakage.

Bedding around the pipe is then put in place before being hand or mechanically compacted. In some areas where additional support and protection is needed, a concrete cap or encasement is placed over the pipe before the top bedding is put in place. As the pipe laying operation proceeds, any lateral lines are connected.

All pipe fittings will be manufactured at the factory and delivered to the site for installation. There will be no requirement for pipe bending at the project site.

**Backfilling and Compaction.** Once the pipe is placed in the proper position and bedding placement is complete, the trench is backfilled and compacted. A loader or backhoe is used to fill the trench with previously excavated soil. Mechanical compacting would be used to compact the soil. Mechanical compacting consists of placing layers of soil or imported fill material over the pipe and compacting each layer with a vibrating roller or other compacting device. For the Proposed Project, the pipe bedding and backfill requirements shall be in accordance with the SCWC's Standard Technical Specifications.

Upon backfilling and soil densification, the trench is temporarily resurfaced. This is then followed by a permanent surface once the project is near completion. In general, resurfacing of previously paved areas involves resurfacing with asphalt or concrete. For construction that occurs in unpaved areas, surface area restoration may include landscaping or restoration of vegetation.

**Testing.** The pipeline will require several tests before it is accepted, including hydrostatic testing. Testing will be conducted per American Water Works Association (AWWA) standards and SCWC's



standard specifications. Water used for pressure testing would be discharged to a storm or sanitary sewer. The water quality must meet the requirements of the contractor’s NPDES permit that places criteria on the quality of the water discharged to the environment. It is unknown where the contractor will obtain the water; however, if the water is potable then it may need to be dechlorinated before discharging.

**Pipe Flushing and Disinfection.** Flushing and disinfection is usually performed right before the pipeline is placed into service. The pipe is flushed to remove remaining particulate matter and then is disinfected. There are generally three accepted ways to disinfect the pipeline: the tablet, continuous feed, and slug method. Each involves filling the pipe with water at a high chlorine concentration to kill bacteria in the pipe. The chlorine dosage is much higher than that acceptable for drinking and must be isolated from the potable water supply during disinfection. Waste disinfection water must meet NPDES discharge criteria, before discharging it to the environment. As a minimum, the water will need to be dechlorinated and may need to be aerated to increase the dissolved oxygen content.

**Cleanup and Restoration.** The restoration process would entail removal or debris, construction signs, surplus material and equipment, followed by re-paving of street surfaces where trenching occurred.

**Crossing Techniques**

The Proposed Project would require a pipe “jacking” technique at a number of locations. Jacking activities require a jacking pit and a receiving pit. Pipe jacking is a method that utilizes a horizontal jack to install the pipelines in a single pass. Although pipe jacking minimizes the surface disruption common to open-trench construction, some surface disruption is unavoidable as this method of construction requires the use of access shafts called jacking pits and receiving pits. A hydraulic jack pushes the pipe segment by segment through the soil from a jacking pit to a receiving pit. Soil is excavated mechanically or manually at the head or leading edge of the pipe. Pipe jacking is normally used for relatively short tunneling installations because frictional resistance increases with length and only very gently curves can be negotiated (SCWC, 1999b).

The dimensions of jacking pits are typically 12 feet wide by 30 feet long by 20 feet deep. Receiving pits are typically 10 feet wide by 10 feet long by 20 feet deep. Boring and jacking is required in certain locations along Segments 5, 6 and 7. As listed in Table B.7-3, the pipeline would require jacking at three locations. A diagram of conventional boring and jacking methods is displayed in Figure B-13.

**Table B.7-3 Pipe Jacking Locations**

Segment #	Location
5	Crossing of the I-405/SR-22 Freeway interchange
6	The intersection of Bolsa Chica Road and Westminster Boulevard
7	U.S. Navy Railroad tracks crossing of Bolsa Chica Street just south of Westminster Boulevard

Source: SCWC, 1999c.

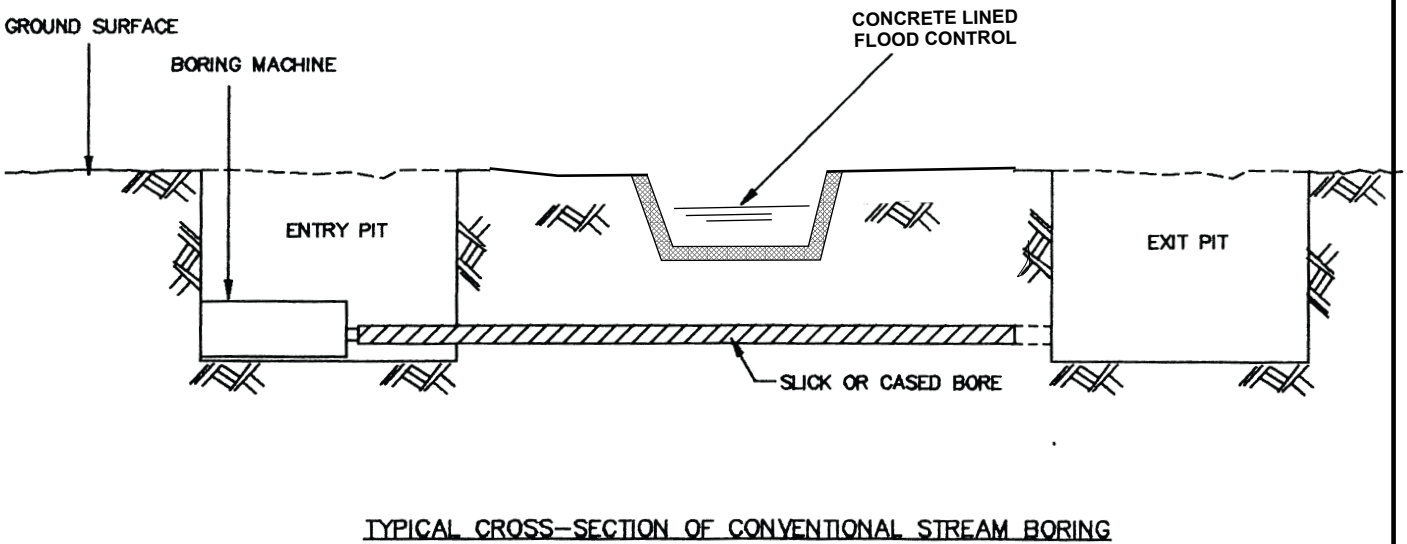
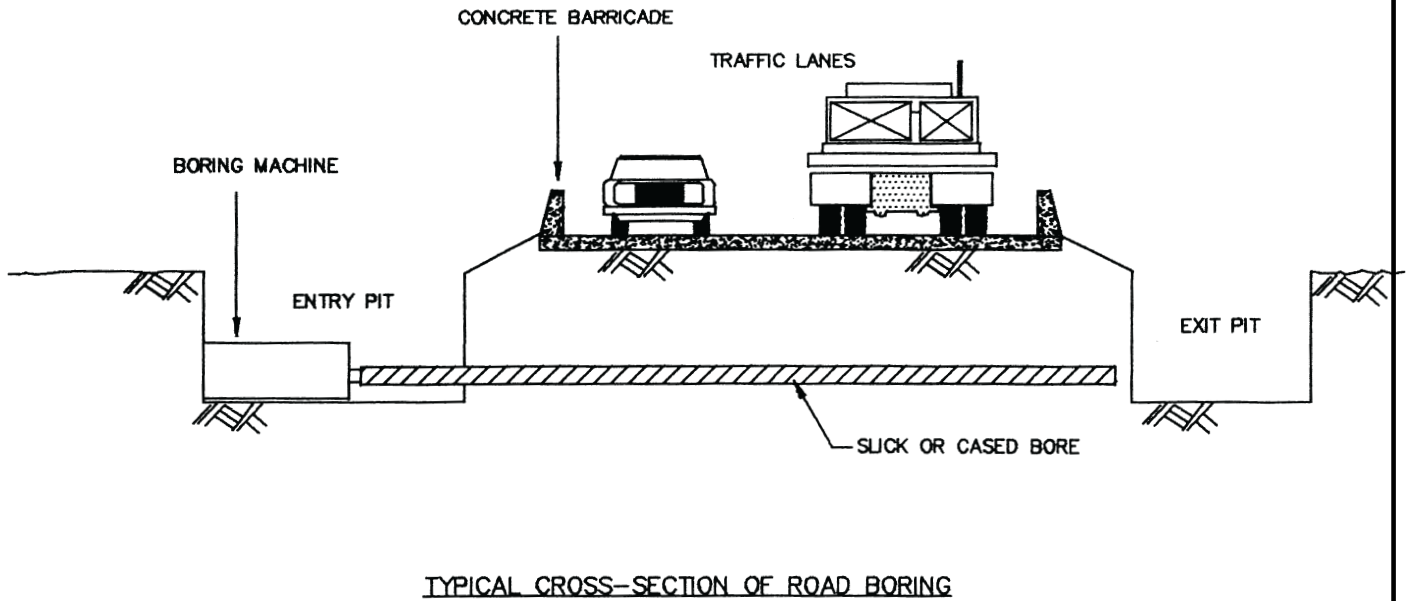

- Note: Boring Locations:
1. The I-405/SR-22 freeway interchange
  2. Intersection of Bolsa Chica Road and Westminster Boulevard
  3. U.S. Navy Railroad crossing of Bolsa Chica Road south of Westminster Boulevard

Source: Proponent's Environmental Assessment  
 Santa Fe Pacific Pipeline Partners  
 Watson To Colton Expansion Project  
 April 1997  
 Woodward-Clyde

**Bolsa Chica Water Line  
 and Wastewater Project**

Figure B-13

**Conventional  
 Boring Operation**

**Aspen**  
 Environmental Group

### **B.7.2 ON-SITE WATER FACILITIES**

Construction of water facilities proposed for the Bolsa Chica Planned Community site were addressed in the *1996 Recirculated Bolsa Chica Report LCP EIR*. Information pertaining to construction of these facilities is presented for informational purposes only.

The construction of the on-site water facilities would occur during the same period as the water transmission line construction. It is assumed that the on-site facilities would be constructed using excavators, backhoes, loaders, bull-dozers, cement mixers, dump trucks, pickup trucks, drill rigs, flat bed trucks, etc. The contractor is not limited in the use of equipment to perform the work.

The site will initially be graded in preparation for construction of the water storage tank, well sites and water pump station. The tank will be located below finished grade so the grading for the tank will involve excavating the hole large enough for the tank and for work around the tank to take place as the tank is built. As grading is commenced at the tank and pump station site, utility installation would commence shortly thereafter. Utilities could include underground piping, such as water and reclaimed water, electrical conduit, etc. After the site has been graded sufficiently, tank and building concrete foundation forms can be built for placement of concrete. Once foundations are complete the tank walls and the walls of the pump station will be built. To secure the building, doors and windows are installed. When walls are complete and the building is secure, mechanical and electrical equipment can be installed followed by the connection of piping and electrical circuits. The control system is usually installed configured following substantial progress of the mechanical and electrical work. The mechanical and electrical equipment and the control system are tested during start-up where the system is operated and problems with the operation of the system are solved before the system is considered complete.

Utilities will also be laid in the streets of the site following rough grading of the streets. Utilities could include all underground piping (natural gas, water and reclaimed water), sewers (sanitary and storm), electrical conduit, manholes, etc. These utilities will be placed in the streets and will terminate at the property lines of the respective lots.

Flushing and disinfection of onsite water piping would be performed in a similar manner to the flushing of the 18" water pipeline. Typically sewer piping is tested for leakage by plugging and filling the pipe between manholes with water above the groundwater level then measuring the leakage after a set period of time. From this test, a leakage rate is calculated and is compared to the acceptable rate to determine whether the pipe has passed.

Steps necessary to flush and disinfect a water tank are slightly different from that for pipelines. Cleaning would involve the removal of construction materials and materials not necessary for operating the tank followed by a thorough cleaning of the tank with high pressure water jet, sweeping, scrubbing, or other equally effective means as necessary. Vents would also be cleaned and checked to prevent

deleterious materials from entering the tank. There are three disinfection methods described in AWWA D105 that the contractor may use to disinfect the potable water storage tank on-site. The first involves filling the tank with chlorinated water and meeting a minimum chlorine residual of 10 mg/l after an established period of time. The second method involves brushing or painting the surfaces with 200 mg/l chlorine solution then filling up the tank and placing it in service pending acceptance by bacteriological testing and aesthetic quality. The third method involves filling the tank with a 2 mg/l chlorine solution followed by bacteriological testing to determine acceptability. Disinfection water resulting from method one will require dechlorination and disposal. Methods two and three provide for the water to be served to the distribution system after testing and acceptance. Only potable water is used for making up and diluting the chlorine solutions.

### **B.7.3 WASTEWATER COLLECTION FACILITIES**

As described in Section B.6.3, the proposed sewer collection system would include the installation of new sewer lines (ranging from 8 to 18 inches in diameter), sewage lift stations, and force mains. It is assumed that construction of the wastewater collection facilities would occur at the same time as the development of the proposed area.

The approximately 12,900 feet of sewer lines and force mains would be trenched using a backhoe or excavator. It is assumed that the sewer lines and force mains would be installed at a depth ranging between 5 feet and 10 feet below the surface. With regard to the sewage lift station, the lift station would be situated in a concrete vault below ground.

All equipment and material would be transported to the site via flatbed trucks. It is anticipated that a construction crew of six to eight personnel would be working on the project site at any one time.

## **B.8 OPERATION AND MAINTENANCE**

### **B.8.1 DOMESTIC WATER TRANSMISSION LINE**

The SCWC Los Alamitos Custom Service Area (CSA) office would be accessible to customers from the Bolsa Chica Planned Community. Personnel at this facility would handle a variety of customer-care issues as well as reports of leaks. This facility handles issues associated with domestic water and wastewater services.

The SCWC Los Alamitos Field Operations Warehouse would coordinate and oversee water services such as repairing main, hydrant and service leaks, new service installations, gate valve and maintenance programs, and 24-hour emergency response. The SCWC ensures that there is a serviceperson available to respond to service problems 24 hours a day, seven days a week. The SCWC deploys an emergency crew immediately upon receiving a call during business hours, and within ten minutes of receiving a call during non-business hours (SCWC 1999a, p. 15).

### **B.8.2 ON-SITE WATER FACILITIES**

The water supply facilities, including wells, boosters, reservoirs and treatment facilities would be visually inspected on a daily basis. All equipment would be inspected in accordance with the manufacturer's recommendations (SCWC, 1999a, p. 15).

The SCWC Los Alamitos CSA office would be accessible to customers from the Bolsa Chica planned community. Personnel at this facility would handle a variety of customer-care issues as well as reports of leaks. The emergency response system provided for wastewater services would be comparable to the emergency response system described above for water services (SCWC 1999a, p. 15). Emergency calls will be answered by SCWC's 24 hour Customer Service Center in San Dimas, California, who would then deploy contractors to respond to the emergency (SCWC 1999a, p. 15).

### **B.8.3 WASTEWATER COLLECTION FACILITIES**

The wastewater collection facilities include design aspects that are intended to reduce operational problems and maintenance. The sewer lift station pumps have been designed to pump water with small foreign debris (SCWC, 1999a, p. 20). Similar automation would be installed to operate these facilities reliably. This automation may include hardwired telemetry or programmable logic controllers to enable SCWC personnel to monitor both an intake pump and sewer lift station's operation remotely (SCWC, 1999a, p. 20).

In relation to the wastewater system, the SCWC intends to hire contractors specializing in sewer system maintenance to provide maintenance for each of the components of the wastewater system (SCWC, 1999a, p. 20). The wastewater maintenance contractors would provide immediate, 24-hour emergency response to any problems occurring in the wastewater system. Emergency calls would initially be answered by SCWC's 24-hour Customer Service Center in San Dimas, California, who would then contact the wastewater contractor to provide prompt emergency response (SCWC, 1999a, p. 15).

## **B.9 INTENDED USES OF THE EIR AND ANTICIPATED PUBLIC AGENCY ACTIONS**

This Supplemental EIR is intended to provide environmental clearance for the Proposed Project pursuant to the California Environmental Quality Act (CEQA). The Final Supplemental EIR must be certified by the CPUC as to its adequacy in complying with the requirements of CEQA before any action is taken to approve the Proposed Project. The CPUC must consider the information contained in the Final Supplemental EIR in making a decision to approve the Proposed Project. In addition to the permit approvals required by the CPUC as the Lead Agency for the Proposed Project, there are a number of permits and approvals required from different public agencies for this project to proceed. Required permits and approvals from other agencies identified to date are listed in Table B.9-1. To the degree required, this Supplemental EIR is intended to provide CEQA clearance for all of the permits approvals listed in Table B.9-1.

To receive construction permits, SCWC may need to submit construction plans and various construction-related documents to local jurisdictions for review. Issuance of required permits will be contingent on compliance with local submission requirements. Construction activities will be required to comply with conditions imposed by local jurisdictions when issuing permits.

**Table B.9-1 Required Permits and Approvals**

Agency	Permit
California Department of Transportation	Encroachment Permit Utility Agreement Temporary Construction Permit Possible need for Right-of-Way Certification
California Department of Health Services	Compliance with design requirements for domestic water line crossing sewer facilities
Regional Water Quality Control Board	National Pollution Discharge Elimination System (NPDES) Storm Water Permit
Cal OSHA, Division of Industrial Safety	Excavation and Shoring Regulations
Los Alamitos Armed Forces Reserve Center	Construction Easement Permanent Use Easement
Orange County Flood Control District	Construction Easement Permanent Use Easement
Orange County	Coastal Development Permit
City of Huntington Beach	Construction Permit Franchise License Agreement Coastal Development Permit
City of Westminster	Construction Permit Franchise Agreement
City of Seal Beach	Public Works Permit
City of Cypress	Public Works Excavation Permit
U.S. Navy	Easement

**B.10 REFERENCES**

COHB (City of Huntington Beach). 1999. *City of Huntington Beach's Closing Brief before the Public Utilities Commission – Testimony in relation to Application No. 9811015 and 9811003*. California Public Utilities Commission.

County of Orange. 1996. *Recirculated Draft Environmental Impact Report, The Bolsa Chica Report, Local Coastal Program*.

CPUC (California Public Utilities Commission). 1999. *Initial Study, Bolsa Chica Domestic Water Transmission Line and Wastewater Service Project*.

SCWC (Southern California Water Company) 1998a. *Application for a Certificate of Public Convenience and Necessity Pursuant to California Public Utilities Code Section 1001 to Extend Its West Orange County System to the Bolsa Chica Planned Community*.

- \_\_\_\_\_. 1998b. *Appendix C Water Supply Supplemental Questionnaire - Application for a Certificate of Public Convenience and Necessity Pursuant to California Public Utilities Code Section 1001 to Extend Its West Orange County System to the Bolsa Chica Planned Community.*
- \_\_\_\_\_. 1998c. *Plan of Works Report for Water and Wastewater.*
- \_\_\_\_\_. 1999a. *Southern California Water Company's Opening Brief - Testimony in relation to Application No. 9811015 and 9811003.* California Public Utilities Commission.
- \_\_\_\_\_. 1999b. *Revised Proponent's Environmental Assessment.* Prepared for the California Public Utilities Commission. January.
- Tetra Tech. 1999. Correspondence from Mr. Jon Austin, Tetra Tech, Inc., to Mr. Ed Moutford, Hearthside Homes, Inc. October 13.