

Southern California Edison
ELM Project A.18-05-007

DATA REQUEST SET A1805007-ED-SCE-DEF-001

To: ENERGY DIVISION
Prepared by: Rey Gonzales
Title: Environmental Project Manager
Dated: 07/17/2018

Question 51 (B-29):

Hazardous Substance Control and Emergency Response Plan

The PEA identifies that a Hazardous Substance Control and Emergency Response Plan will be required but provides no specific information on content.

A. For this plan, please provide (1) the required plan in draft or (2) an APM that specifies the content of the plan that will be provided.

Response to Question 51 (B-29):

A Hazardous Substance Control and Emergency Response Plan will be developed and submitted to the CPUC prior to the start of construction. The plan will accomplish the following:

- identify and describe the appropriate control methods, approved containment, and spill control practices that will be implemented for construction and on-site hazardous material storage;
- describe methods by which all hazardous materials and hazardous wastes will be handled, stored, and disposed of in accordance with all applicable regulations;
- include procedures for the regular inspection of vehicles and equipment parking near sensitive resource areas during construction; and define spill containment procedures and emergency response and reporting to address hazardous material releases.

Southern California Edison
ELM Project A.18-05-007

DATA REQUEST SET A1805007-ED-SCE-DEF-001

To: ENERGY DIVISION
Prepared by: Rey Gonzales
Title: Environmental Project Manager
Dated: 07/17/2018

Question 52 (B-29):

Health and Safety Plan

The PEA identifies that a Health and Safety Plan will be required but provides no specific information on content.

A. For this plan, please provide (1) the required plan in draft or (2) an APM that specifies the content of the plan that will be provided.

Response to Question 52 (B-29):

A Health and Safety Plan will be developed and submitted to the CPUC prior to the start of construction. The plan will describe the measures that will be implemented to minimize safety-related situations that could occur and provide procedures to assist in the protection of workers and the general public during the construction phase of the Project. The plan will accomplish the following:

- Educate construction workers on the hazards associated with the Project site and how to identify them, the safety measures that must be taken to prevent injury, how to identify potentially contaminated soils and/or groundwater, and the procedures for ensuring personnel receive necessary training;
- Identify federal and state occupational standards regarding occupational safety and safe work practices;
- Establish fire safety evacuation procedures;
- Explain the appropriate response actions for each safety hazard and develop a mechanism for reporting serious accidents to appropriate agencies and for notifying the appropriate authorities of safety issues;
- Identify requirements for temporary fencing around staging areas, storage yards, and excavation areas during construction or decommissioning activities, as well as appropriate measures to be taken during construction of the Project to limit public access to hazardous facilities;

- Designate an environmental field representative to be on site to observe, enforce, and document adherence to the Health and Safety Plan; and
- Identify where medical kits are located.

Southern California Edison
ELM Project A.18-05-007

DATA REQUEST SET A1805007-ED-SCE-DEF-001

To: ENERGY DIVISION
Prepared by: Rey Gonzales
Title: Environmental Project Manager
Dated: 07/17/2018

Question 53 (B-29):

Worker Environmental Awareness Program (WEAP)

The PEA identifies that a WEAP will be required but provides no specific information on content.

A. For this plan, please provide (1) the required plan in draft or (2) an APM that specifies the content of the plan that will be provided.

Response to Question 53 (B-29):

A comprehensive Worker Environmental Awareness Program (WEAP) will be prepared prior to construction and delivered to all developer, contractor, and subcontractor personnel that will be working on the construction right-of-way. The training will review the following:

- Project background;
- Procedures for supervisory personnel, communication protocols, project changes, and agency coordination;
- Key staff assigned to the project and their roles;
- Jurisdictional agencies and project permitting;
- Agency expectations;
- Sensitive habitat and species issues, including photographs; and
- Project-specific mitigation measures and permit conditions.

California Joint Utility Traffic Control Manual

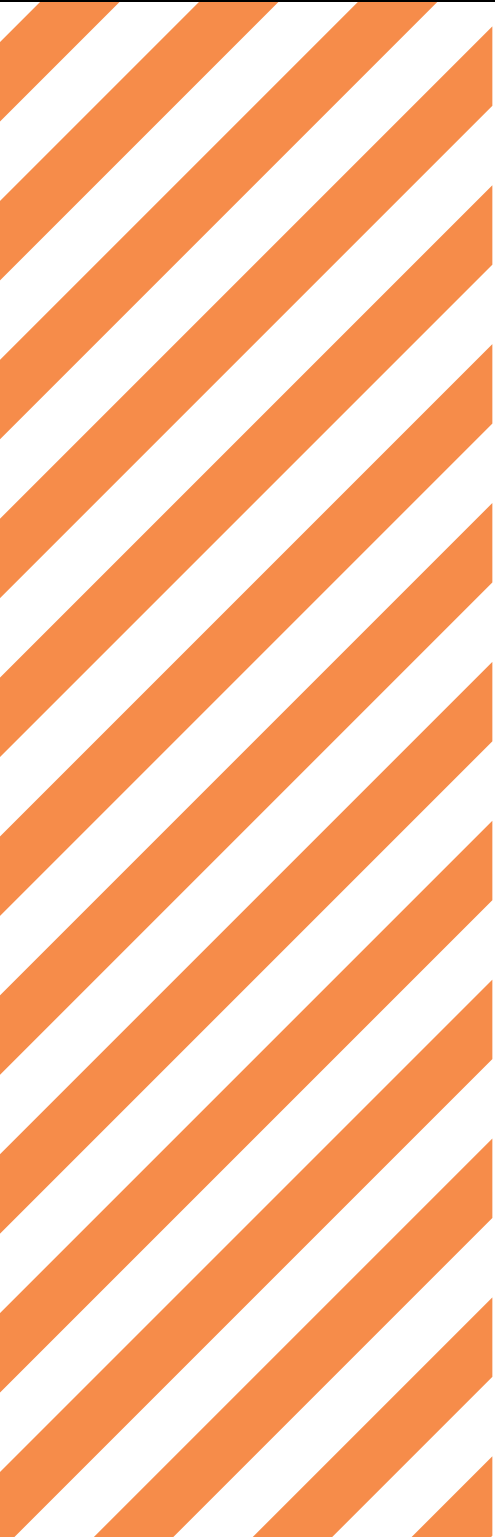

TABLE OF CONTENTS

ENDORSEMENTS..... 5

INTRODUCTION TO THE FIFTH EDITION 7

PUBLIC UTILITIES CODE..... 9

CALIFORNIA JOINT UTILITY TRAFFIC CONTROL MANUAL 10

Fundamental Principles 10

TEMPORARY TRAFFIC CONTROL (TTC) GENERAL/REFERENCE INFORMATION 12

Short Duration Work Operations 12

End of Work Period 13

Night Operations 14

TTC Sign Recommendations 14

 OPEN TRENCH Sign (C27(CA))..... 14

 FIGURE A – Use of C27 Open Trench Sign..... 15

Table A - Suggested Minimum Advance Warning Sign Spacing 16

Table B - Taper Length Criteria for Temporary Traffic Control Zones 16

Table C - Formulas for Determining Taper Lengths 16

Table D – Buffer Space Table 17

Table E - Taper Length Criteria for Temporary Traffic Control zones..... 17

Channelizing Devices 18

Table F – Maximum Spacing of Channelizing Devices 18

Barricades 19

Arrow Panels 19

Table G – Arrow Panel Table 20

Flagger Reference Information..... 20

FLAGGING TRAFFIC 21

REFERENCE SIGN CHART 24

DRAWING LIST

DRAWINGS SUBURBAN/RURAL SECTION

Two Lane Traffic Control without Centerline.....1

Work in Center of Road (w/Centerline) – Two Lane Traffic Control.....2

Work in Center of Road (w/o Centerline) – Two Lane Traffic Control.....3

Midblock Half Street Closure – Flagger Control.....4

Single Lane Closure for One Way Street.....5

Multi Lane Closure for One Way Street – Right Lanes Closed.....6

Single Lane Closure – Right Lane using Left Turn Lane.....7

Left Turn Lane Closure – Midblock.....8

Single Lane Closure – Right Lane.....9

Shoulder Closure10

Midblock Closure for One Direction of Traffic.....11

Midblock No. 1 Lane Closure.....12

Midblock No. 1 Lane and Left Turn Lane Closure.....13

Midblock No. 1 Lanes and Left Turn Lane Closure.....14

Midblock No. 1 Lane Closures for Both Lanes of Traffic.....15

Midblock Half Street Closure – Using Left Turn Lane as Traveled Lane...16

Multi Lane Closure – Right Lanes and Left Turn Lanes.....17

Edge of Gutter Closure.....18

Middle Lane Closure.....19

Multi Lane Closure – Right Lanes.....20

Midblock Closure of No. 2 Lane and Curb Lane.....21

Multi Lane Closure – Left Lanes.....22

Work Beyond Intersection – Right Lane.....23

Work Beyond Intersection – Left Lane.....24

Work Beyond Intersection – Right Side Single Thru Lane.....25

Work Beyond Intersection – Left Side Single Thru Lane.....26

Left Turn Lane Closure – At Intersection.....27

Work Within Intersection – Left Lane/Left Turn Lane.....28
Work Within Intersection – Right Lane/Left Turn Lane.....29

DRAWINGS URBAN SECTION

Intersection Work – Right/Center.....30
Intersection Work – Right/Left.....31
Beyond Intersection – Far Left.....32
Intersection Work – Center.....33
Intersection Work – Right.....34
Intersection Work – Right.....35
Intersection Work – Center.....36
Intersection Work – Right/Center.....37
Intersection Work – Right/Center.....38
Intersection Work – Right.....39
Intersection Work – Far Left/Right40
Half Street Closure – Far Side.....41
Half Street Closure – Near Side.....42
Full Street Closure – Two Way Street.....43
Full Street Closure – One Way Street.....44
Sidewalk Closure – Right/Center.....45
Sidewalk Closure.....46
Sidewalk Closure.....47
Sample Traffic Circulation Plan.....48

The California Joint Utility Traffic Control Manual is a joint effort among members of the California Inter-Utility Coordinating Committee. The member logos below are proudly displayed as a sign of their support in developing safe working conditions for their employees as well as for the traveling public. We are a dedicated group who wants safety first. As you read through this manual, please keep in mind that safety is everyone's business and it is up to each one of us to do our part in ensuring a safe work zone.



ENDORSEMENTS

California Department of Transportation (Caltrans) has reviewed the California Joint Utility Traffic Control Manual and finds it to be in conformance with the California Manual on Uniform Traffic Control Devices for Streets and Highways (FHWA's MUTCD 2003 Revision 2, as amended for use in California) also called California MUTCD 2010 issued by Caltrans on January 21, 2010.

Caltrans is not responsible for the content of this manual and it is up to the local jurisdiction to ensure the plans and traffic control being used are appropriate for the field conditions and work being performed. When working on State Highways in California refer to the California MUTCD 2010 and use the existing encroachment permit processes.

Gurinderpal (Johnny) Bhullar, P.E., T.E.
Senior Transportation Engineer
Editor, California MUTCD
Office of Signs, Markings & External Support
Caltrans, Division of Traffic Operations, MS-36
1120 N St., Sacramento, CA 95814
916-654-7312
johnny.bhullar@dot.ca.gov

I have been using the California Joint Utility Traffic Control Manual for more than 8 years because it has proven to be a sound resource for routine permit work within the public right of way. The modifications included in this edition ensure that safe work zones are properly set up to perform standard utility repairs and maintenance within the public right of way. This manual may help expedite the permitting process by notifying the jurisdictional agency exactly what traffic control will be used to successfully complete the permitted work.

Nelson D. Nelson, P.E.
City of Corona
Assistant Public Works Director/Assistant City Engineer

The City of Corona is not responsible for the content of this manual and it is up to the local jurisdiction to ensure the plans and traffic control being used are appropriate for the field conditions and work being performed.

The **City of Dana Point** allows encroachment permit applicants (applicants), generally Contractors and Utility Companies, to use the California Joint Utility Traffic Control Manual, among other publications via City Ordinance 14.01.220 Safety and Warning Devices Required. The guidelines and manuals noted in this ordinance are invaluable tools to applicants that need to accomplish work in City Streets. In a number of cases, these standard documents have helped these applicants in the City of Dana Point avoid expense in generating traffic control plans, as these plans specifically accommodate their needs, and provide for a safe working environment. The City will continue to allow these manuals/guidelines to be utilized to accomplish work in our rights-of-way. Of course, any Contractor or Utility Company doing work in any City street assumes all responsibility and liability.

Matthew Sinacori, P.E.
City Engineer
City of Dana Point
phone (949) 248-3574
fax (949) 234-2826

After reviewing the manual and its accompanying drawings I can completely endorse the use of the manual for routine utility work within Covina's rights-of-way.

Steve Henley
City of Covina
Public Works Director

The city of Claremont endorses the use of the (CJUTCM) manual.

Craig Bradshaw
City of Claremont
Senior City Engineer

Introduction to the Fifth Edition

This Manual is coordinated and prepared by the California Joint Utility Traffic Control Committee. It provides the basic standards for the safe movement of traffic upon highways or streets in accordance with Section 21400 of the California Vehicle Code and the California Manual on Uniform Traffic Control Devices for Street and Highways 2010 Edition. Traffic control includes safe protection for the public, motorist, cyclist, pedestrian and worker. It is the responsibility of the contractor or organization performing work on, or adjacent to, a roadway to install and maintain such devices which are necessary to provide safe passage for the traveling public through the work area and for the safety of the workers.

This text is not intended to establish or create a legal standard. The criteria for the position, location, manner of installation, and the use of such signs, lights and devices are furnished solely for the purpose of information and guidance. This manual will be updated as required to conform to Federal and State guidelines. When working on State Highways in California refer to the California Manual on Uniform Traffic Control Devices for Streets and Highways 2010 Edition and use the existing encroachment permit processes.

California Joint Utility Traffic Control Committee Members:

Reed Reisner	SCE --- Committee Chairman
Patti Good	SDG&E [®] --- Committee Vice Chairman
Louis Renner	PG&E
John Gilginas	PG&E
Mike Harriel	Southern California Gas Company
Mike Riley	Verizon
Oscar Escobar	Verizon
Kristin Maldonado	Verizon
Gail Dafun	AT&T
Dennis Buss	SDG&E [®]

Technical Review Team:

I have reviewed the Manual prepared by the California Joint Utility Traffic Control Committee and am pleased to endorse it.

LOUIS RENNER, Certified Safety Professional Certification # 11510
Board of Certified Safety Professionals (BCSP) 208 Burwash Avenue, Savoy, IL
Phone: 415-973-7470, Fax: 415-973-1390, Email: LPR3@pge.com
Pacific Gas and Electric Company. 77 Beale Street, Mail Code B23H Rm. 2854A
San Francisco, CA 94105

JOHN GILGINAS, Certified Safety Professional Certification # 18487
BCSP 208 Burwash Avenue, Savoy, IL
Phone: 415-973-2454, Fax: 415-973-1390, Email: JPGd@pge.com
Pacific Gas & Electric Company. 77 Beale Street, Mail Code B23H Rm. 2882
San Francisco, CA 94105

PARDUMAN S. MARWAH, RCE # 25380 State of California
Phone: 909-274-1436, Fax: 909-274-1465, Email: marwahps@sce.com
Southern California Edison Company. One Innovation Way.
Pomona, CA 91768
(For technical questions related to SCE work please contact Noe Bargas)

NOE BARGAS, Engineer
Phone: 909-274-1457, FAX: 909-274-1465, Email: noe.bargas@sce.com
Southern California Edison Company. One Innovation Way.
Pomona, CA 91768

MIKE HARRIEL, Technical Supervisor
Phone: 714-634-3278, Fax: 714-634-7287, Email: MHarriel@semprautilities.com
Southern California Gas Company. 1919 S. State College Blvd, Mail Code SC8321
Anaheim, CA 92806-6114

MIKE RILEY, Outside Plant Network Engineering Manager, South Division
Phone: 909-748-6650, Email: mike.riley@verizon.com
Verizon. 1980 Orange Tree Ln., Suite 100
Redlands, CA 92374

OSCAR ESCOBAR, Outside Plant Network Engineering Manager, East Division
Phone: 909-469-6351, Email: oscar.escobar@verizon.com
Verizon. 1400 E. Phillips Blvd.
Pomona, CA 91766

KRISTIN MALDONADO, Outside Plant Network Engineering Section Manager, Tri-Valley District
Phone: 951-925-5319 Email: kristin.m.maldonado@verizon.com
Verizon. 150 S. Juanita St.
Hemet, CA 92543

BRIAN R. TODD, Outside Plant Engineer South C&E Region
Phone: 714-666-5518, Fax: 714- 630-6617, Email: bt1469@att.com
AT&T California. 1265 N. Van Buren St Floor Room 180
Anaheim, CA 92807-1608

JAIME BORRUEL, TCP Specialist
Phone: 858.636.5589, Email: jborruel@semprautilities.com
San Diego Gas & Electric®

Public Utilities Code

AT&T and Verizon as telephone utilities have been granted by the State the right to use public streets. This grant, known as the state franchise is found in Section 7901 of the California Public Utilities Code. Section 7901 provides that:

“Telegraph or telephone corporations may construct lines of telegraph or telephone lines along and upon any public road or highway, along or across any of the waters or lands within this State, and may erect poles, posts piers, or abutments for supporting the insulators, wires, and other necessary fixtures of their lines, in such manner and at such points as not to incommode the public use of the road or highway or interrupt the navigation of the waters.”

Many cities and counties have granted Southern California Edison, as an electric utility, San Diego Gas & Electric, as a gas and electric utility, Southern California Gas Company, as a gas utility, and Pacific Gas and Electric Company as an electric and gas utility the right to use public streets. These grants, known as the city or county franchises, are granted in accordance with: (1), the Broughton Act, set forth in Section 6001, et seq. of the Public Utilities Code, or (2) the Franchise Act of 1937, set forth in Section 6201, et seq. of the Public Utilities Code.

Illustrative of the franchise rights granted by counties and cities to public utilities, Section 6265 of the Public Utilities Code provides that:

“Every gas franchise granted pursuant to this chapter confers upon the grantee the right to use, or to lay and use, gas pipes and appurtenances for the purpose of transmitting and distributing oil or products thereof; every industrial gas franchise so granted confers upon the grantee the right to use, or lay and use industrial gas pipelines and appurtenances for the purpose of transmitting and distributing industrial gas;... and every electric franchise so granted confers upon the grantee thereof the right to use, or to construct and use, poles, wires or conduits and appurtenances for the purpose of transmitting and distributing electricity for all purposes, under, along, across, or upon the public streets, ways, alleys, and places as they now or hereafter exist within the municipality.”

California Joint Utility Traffic Control Manual

Fundamental Principles:

The needs and control of all road users (motorists, bicyclists and pedestrians within the highway including persons with disabilities in accordance with the Americans with Disabilities Act of 1990 (ADA) Title II, Paragraph 35.130) through a temporary traffic control (TTC) zone shall be an essential part of highway construction, utility work, maintenance operations and the management of traffic incidents.

Those using the roadway (motorists, bicyclists and pedestrians), worker safety at the job site and accessibility in TTC zones should be an integral part of every project initiated in the planning phase and continuing through design and construction. In a like fashion, maintenance and utility work should be planned and conducted with the safety and accessibility of all motorists, bicyclists, pedestrians (including those with disabilities) as well as the safety of those workers performing the work.

NOTE: Work around a railroad or highway rail grade crossing will require early coordination with the railroad company prior to work planning.

To provide safety for motorists, bicyclists, pedestrians, workers, enforcement/emergency officials and equipment at the job site, the following factors must be considered:

1. Safety principles governing the design of permanent roadways and roadsides should also govern the design of temporary traffic control zones. The goal should be to route road users through such zones using roadway geometrics, roadway features and temporary traffic controls as nearly as possible comparable to those for normal highway/traffic situations.
2. A temporary traffic control plan should be prepared and understood by all responsible parties before the site is occupied. Any changes in the TTC plan shall be approved by the Engineer of the public agency or authority having jurisdiction over the highway.

Road user movement should be inhibited as little as practical, based on the following considerations:

1. TTC at work and incident sites should be designed on the assumption that drivers will only reduce their speeds if they clearly perceive a need to do so.
2. Frequent and abrupt changes in geometrics such as lane narrowing, dropped lanes or main roadway transitions that require rapid maneuvers should be avoided.
3. Provisions shall be made for the reasonably safe operation of work, particularly on high-speed, high-volume roadways.
4. Road users should be encouraged to use alternative routes that do not include TTC zones.
5. Bicyclists and pedestrians, including those with disabilities, should be provided with access and reasonably safe passage through the TTC zone.

NOTE: The context of through does not mean a bicyclist or pedestrian may enter a TTC zone but that passage is provided in the bike lane or crosswalk for a bicyclist and on the sidewalk or crosswalk for a pedestrian to navigate past or around (i.e. through) the TTC zone.

The following three items should be considered when planning for pedestrians in TTC zones:

Pedestrians should not be led into conflicts with work site vehicles, equipment or operations.

Pedestrians should not be led into conflicts with vehicles moving through or around the worksite.

Pedestrians should be provided with a reasonably safe, convenient and accessible path that replicates as nearly as possible the most desirable characteristics of the existing sidewalks (s) or footpath (s). Where pedestrians who have visual disabilities encounter work sites that require them to cross the roadway to find an accessible route, instructions should be provided using an audible information device.

6. Roadway occupancy should be scheduled during off-peak hours and, if necessary, night work should be considered.
7. Early coordination with officials having jurisdiction over the affected cross streets and providing emergency services should occur before roadway or ramp closures.

Motorists, bicyclists and pedestrians should be guided in a clear and positive manner while approaching and traversing TTC zones and incident sites. The following principles should apply:

- A. Adequate warning, delineation and channelization (tapers) should be provided to assist in guiding road users in advance of and through (i.e. past or around) the TTC zone or incident site by using proper pavement marking, signing, or other devices that are effective under varying conditions. Providing information that is in usable formats by pedestrians with visual disabilities should also be considered.
- B. TTC devices inconsistent with intended travel paths through (i.e. past or around) should be removed or covered. Intermediate-term stationary, short term, and mobile operations, where visible permanent devices are inconsistent with intended travel paths, devices that highlight or emphasize the appropriate path should be used (attached directional arrow indicators on a vehicle). Providing information that is in usable formats by pedestrians with visual disabilities should also be considered.
- C. Flagging procedures, when used, should provide positive guidance to road users traversing the TTC zone.

NOTE: Flaggers must have received the State of California Title 8, Construction Safety Orders, Section 1599 (f) "Training of Construction Site Flaggers" prior to performing flagger duties (See reference section).

- D. Inspect the TTC zone to make sure warning flags are not wrapped around supports. Inspect warning signs for proper visibility, barricade lights or flashers for visibility and function. A good test of a TCC zone is to drive through the zone yourself, in addition to observing traffic, to determine if there is an orderly

transition. For nighttime work, lighting the work zone and approaches will allow the motorist better comprehension of imposed requirements. Since traffic patterns change, observation should be conducted periodically and adjustments made accordingly to assure traffic flow.

Each person whose actions affect the TTC zone safety, from upper-management through the field worker, should receive training appropriate to the job decisions each individual is required to make. Only those individuals who are trained in proper TTC practices and have a basic understanding of the principles (established by applicable standards and guidelines) should supervise the selection, placement and maintenance of TTC devices for TTC zones and for incident management.

NOTE: Before any new detour or temporary route is opened to traffic, all necessary signs shall be in place. All TTC devices shall be removed as soon as practical when they are no longer needed. When work is suspended for short periods of time, TTC devices that are no longer appropriate shall be removed or covered.

Good public relations should be maintained by applying the following:

1. The needs of the road user should be assessed such that appropriate advance road notice is given and clearly defined alternative paths are provided.
2. The cooperation of the various news media should be sought in publicizing the existence and reason for the TTC zones as news releases can assist by keeping the road user well informed.
3. The needs of abutting property owners, residents, and businesses should be assessed and appropriate accommodations made.
4. The needs of emergency service providers (law enforcement, fire, and medical) should be assessed and appropriate coordination and accommodations made.
5. The needs of railroads and transit should be assessed and appropriate coordination and accommodations made.
6. The needs of operators of commercial vehicles such as busses and large trucks should be assessed and appropriate coordination and accommodations made.

Temporary Traffic Control (TTC) General/Reference Information

Short Duration Work Operations

The CA MUTCD addresses work duration under section 6G.02 **Work Duration** and states:

Work duration is a major factor in determining the number and types of devices used in TTC zones. The duration of a TTC zone is defined relative to the length of time a work operation occupies a spot location.

Standard:

The five categories of work duration and their time at a location shall be:

- A. Long-term stationary is work that occupies a location more than 3 days.
- B. Intermediate-term stationary is work that occupies a location more than one daylight period up to 3 days, or nighttime work lasting more than 1 hour.

C. Short-term stationary is daytime work that occupies a location for more than 1 hour within a single daylight period.

D. Short duration is work that occupies a location up to 1 hour.

E. Mobile is work that moves intermittently or continuously.

Standard:

Since intermediate-term operations extend into nighttime, retroreflective and/or illuminated devices shall be used in intermediate-term stationary TTC zones.

Support:

Most maintenance and utility operations are short-term stationary work.

As compared to stationary operations, mobile and short-duration operations are activities that might involve different treatments. Devices having greater mobility might be necessary such as signs mounted on trucks. Devices that are larger, more imposing, or more visible can be used effectively and economically. The mobility of the TTC zone is important.

Maintaining reasonably safe work and road user conditions is a paramount goal in carrying out mobile operations.

Guidance:

Safety in short-duration or mobile operations should not be compromised by using fewer devices simply because the operation will frequently change its location.

Option:

Appropriately colored or marked vehicles with high-intensity rotating, flashing, oscillating, or strobe lights may be used in place of signs and channelizing devices for short-duration or mobile operations. These vehicles may be augmented with signs or arrow panels.

Support:

During short-duration work, it often takes longer to set up and remove the TTC zone than to perform the work. Workers face hazards in setting up and taking down the TTC zone. Also, since the work time is short, delays affecting road users are significantly increased when additional devices are installed and removed.

Option:

Considering these factors, simplified control procedures may be warranted for short-duration work. A reduction in the number of devices may be offset by the use of other more dominant devices such as high-intensity rotating, flashing, oscillating, or strobe lights on work vehicles.

End of Work Period

Before leaving a work area, it is necessary that approved warning devices be placed to protect motorists, bicyclists or pedestrians.

1. Ensure the area is properly barricaded and that flashing lights, where required, are functioning satisfactorily.

2. Make sure that equipment is secured and that the work area is left orderly. Cover or barricade exposed openings (trenches, excavations, bell holes, etc.) to assure protection of the public.

Night Operations

Night Operations should be set up pursuant to the National Cooperative Highway Research Program (NCHRP) report 476, guidelines for design and operation of nighttime traffic control for highway maintenance and construction.

In order to provide enhanced warning and safety during twilight and night operations, the following steps are recommended:

1. When the work area is to be illuminated by use of flood lights, the light placement shall be such that the light beams are not hazardous to oncoming traffic.
2. All warning signs and channelizers shall have reflective properties.
3. Flashing or rotating amber lights on vehicles may be used when the vehicles are blocking established traffic lanes or for additional work area protection.

NOTE: Flares and red emergency lights and reflectors are strictly for emergency situations and must not be used as substitutes for standard work area warning devices. Flares shall not be used in high hazard fire areas.

TTC Sign Recommendations

All temporary traffic control signs shall be sized to be in accordance with CA MUTCD Table 6F-1, *Sizes of Temporary Control Signs*.

Approved warning signs shall be installed and properly maintained whenever hazards exist due to moving or stationary vehicles, open excavations, construction or maintenance operations or similar work. Warning signs shall be placed so as to provide adequate notice to motorists, bicyclists or pedestrians that they are approaching an excavation, obstruction or hazard. Warning signs shall be removed as soon as the excavation, obstruction or hazard is removed or cleared.

California MUTCD Section 6F.105(CA):

OPEN TRENCH Sign (C27(CA))

The OPEN TRENCH sign shall be used in advance of open trenches in/or adjacent to roadway. The edge of the traveled way shall be defined by edge line delineation consisting of appropriate markers or striping. Edge line delineation shall be white when located on the right of traffic and yellow when located on the left of traffic.

Standard:

Trenches in excess of 0.25 ft (3-inches) in depth that are less than 8 ft from the edge of traveled way shall be identified by C27(CA) and NO SHOULDER (C31A(CA)) portable signs on Type II or Type III barricades alternately set in the trench at intervals not to exceed 2,000 ft.

Use of C27(CA) and C31(CA) signs shall be incorporated into all temporary traffic control drawings contained in this manual where trenches are within 8-ft of the traveled way. See Figure A for reference.

FIGURE A – Use of C27 Open Trench Sign

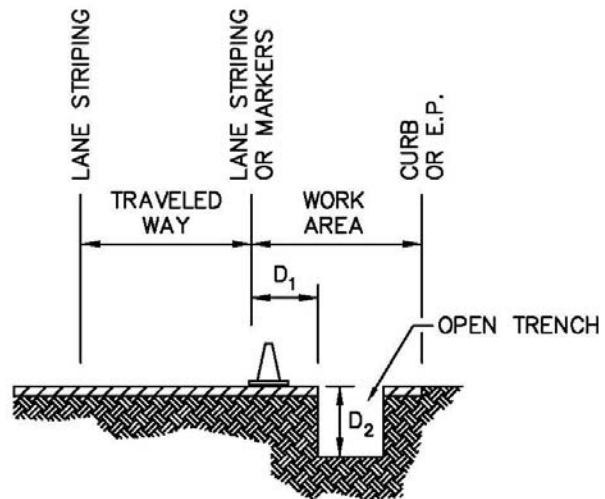
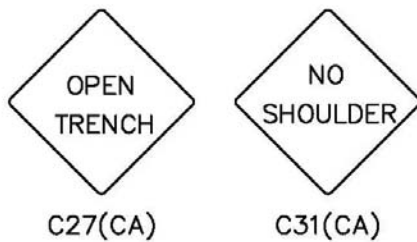
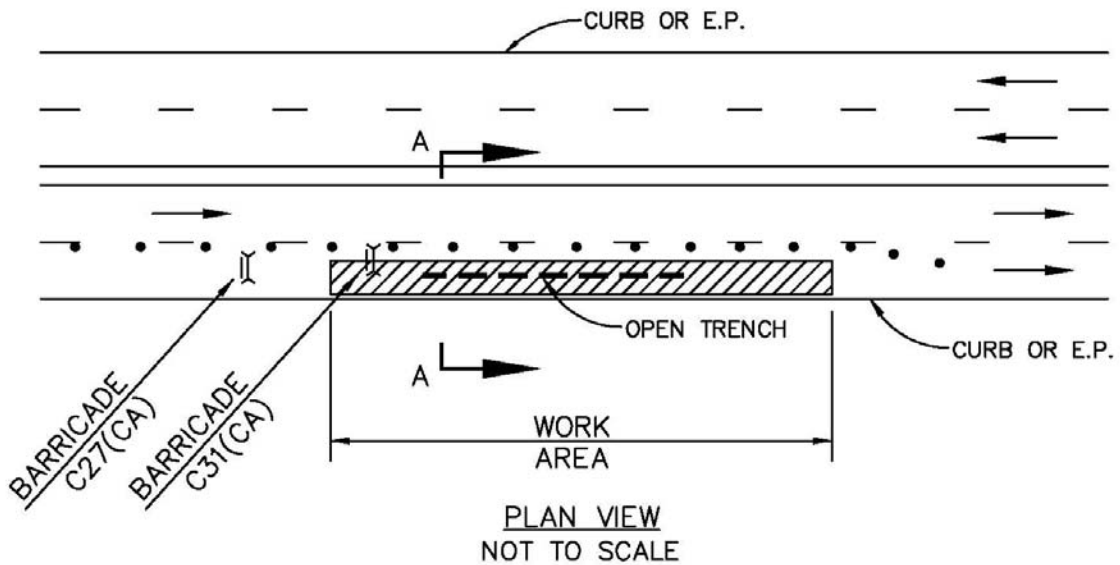

NOTE:

1. C27 AND C31 SIGNS SHALL BE USED WHEN TRENCH D_1 IS 8-FT OR LESS AND D_2 IS 0.25-FT (3-INCHES) OR GREATER.
2. D_1 SHALL NOT BE LESS THAN 5-FT.

Table A - Suggested Minimum Advance Warning Sign Spacing

Posted Speed	Distance Between Signs **		
	A	B	C
Urban (low speed) 25 mph or less *	100	100	100
Urban (high speed) 30 mph or more *	350	350	350
Rural	500	500	500
55 mph & above	1,000	1,500	2,640

* Speed category to be determined by highway agency.

** Distances are shown in feet. **The column headings A, B, and C are the dimensions shown on drawings No. 1-51.** The A dimension is the distance from the transition or point of restriction to the first sign. The B dimension is the distance between the first and second signs. The C dimension is the distance between the second and third signs. (The third sign is one in a three sign series encountered by a driver/motorist approaching a TTC zone).

Table B - Taper Length Criteria for Temporary Traffic Control Zones

Type of Taper	Taper Length (L)
Merging Taper	at least L
Shifting Taper	at least 0.5L
Shoulder Taper	at least 0.33L
One-Lane, Two-Way Traffic Taper	100 feet maximum
Downstream taper	100 feet per lane

Table C - Formulas for Determining Taper Lengths

Speed Limit	Taper Length (L) Feet
40 mph or less	$L = WS^2/60$
45 mph or more	$L = WS$

Where: L = taper length in feet
 W = width of offset feet
 S = posted speed limit, or off peak 85th- percentile speed prior to work starting. Or the anticipated operating speed in mph

Table D – Buffer Space Table

Speed (mph)	% Downgrade (Buffer Space)			
	<-3% (ft)	-3% (ft)	-6% (ft)	-9% (ft)
20	115	116	120	126
25	155	158	165	173
30	200	205	215	227
35	250	257	271	287
40	305	315	333	354
45	360	378	400	427
50	425	446	474	507
55	495	520	553	593
60	570	598	638	686
65	645	682	728	785
70	730	771	825	891

Table E - Taper Length Criteria for Temporary Traffic Control zones for 12 feet Offset Width

Speed* S (mph)	Minimum Taper Length ** For Width of Offset 12 ft (W)			Down Stream (ft)
	Merging L (ft)	Shifting L/2 (ft)	Shoulder L/3 (ft)	
20	80	40	27	100
25	125	63	42	100
30	180	90	60	100
35	245	123	82	100
40	320	160	107	100
45	540	270	180	100
50	600	300	200	100
55	660	330	220	100
60	720	360	240	100
65	780	390	260	100
70	840	420	280	100

* - Posted Speed, off peak 85th percentile speed prior to work starting, or the anticipated operating speed.

** - For other offsets use the following merging taper length formula for L:
 For speeds of (40 mph) or less ($L=WS^2/60$)
 For speeds of (45 mph) or more ($L=WS$)

Channelizing Devices

Channelizing devices (cones, tubular markers, drums or vertical panels) are elements in a total system of temporary traffic control for use during construction and maintenance operations. These elements shall be preceded by a subsystem of warning devices, adequate in size, number and placement for the type of roadway on which the work will take place.

Channelizing devices can be used as follows:

1. To channel and/or divert traffic in advance of a temporary traffic control zone (work zone).
2. To define traffic lanes through the work zone.
3. To define a change in the position of the lanes around a work zone.
4. On detours to define curves and the edges of the roadway.
5. To separate opposing lanes of traffic.

Table F – Maximum Spacing of Channelizing Devices

Speed (mph)	Maximum Channelizer Spacing		
	Taper* (ft)	Tangent (ft)	Conflict** (ft)
20	20	40	10
25	25	50	12
30	30	60	15
35	35	70	17
40	40	80	20
45	45	90	22
50	50	100	25
55	55	110	27
60	60	120	30
65	65	130	32
70	70	140	35

* Maximum channelizer spacing for all speeds on one-lane/two-way tapers is (20 ft). Maximum channelizer spacing for all speeds on downstream tapers is (20 ft). All other tapers are as shown.

** Use on intermediate and short term projects for taper and tangent sections where there are no pavement markings or where there is a conflict between existing pavement markings and channelizers.

On State highways a spacing of 10 ft is recommended for tapers and tangent sections.

Barricades

The function of barricades is to separate the motorist from objects or unusual situations created by construction or maintenance operations in or near the traveled way. Barricades should not be used to guide motorist through the transition or work zones.

The barricade would not be used where a collision with the barricade would be more severe than a collision with the object being separated. At such locations, channelizers or similar less rigid devices should be used.

Barricade design:

Barricades for vehicular traffic shall be of three types conforming to the CA MUTCD: Type I, Type II and Type III. Markings for barricades shall be alternate orange and white stripes sloping downward at a 45 degree angle. The entire area of orange and white shall be effectively reflectorized. Other barricade components shall be predominately the color white.

Arrow Panels

California MUTCD Section 6F.56 Arrow Panels:

An arrow panel shall be a sign with a matrix of elements capable of either flashing or sequential display. This sign shall provide additional warning and directional information to assist in merging and controlling road users through or around a Temporary Traffic Control (TTC) zone.

Guidance: An arrow panel in the arrow or chevron mode should be used to advise approaching traffic of a lane closure along major multi-lane roadways in situations involving heavy traffic volumes, high speeds and/or limited sight distances or at other locations and under the conditions where road users are less likely to expect such lane closures. When used, an arrow panel should be used in conjunction with appropriate signs, channelizing devices, or other TTC devices. An arrow panel should be placed on the shoulder of the roadway or if practical, further from the traveled lane. It should be delineated with retro reflective devices. When the arrow panel is not being used, it should be removed, if not removed, it should be shielded, or if the previous two options are not feasible, it should be delineated with retro reflective devices.

Standard: When arrow panels are used to close multiple lanes, a separate arrow panel shall be used for each closed lane.

Guidance: When arrow panels are used to close multiple lanes, if the first arrow panel is placed on the shoulder, the second arrow panel should be placed in the first closed lane at the beginning of the second merging taper. When the first arrow panel is placed in the first closed lane, the second arrow panel should be placed in the second closed lane at the downstream end of the second merging taper.

Table G – Arrow Panel Table

Panel Type	Minimum Size	Minimum Legibility Distance	Minimum Number of Elements
Type A – Low Speed Urban Areas	(48 X 24 inches)	(0.5 or ½ miles)	12
Type B or II – Intermediate speed facilities or mobile operations on high –speed roadways	(60 X 30 inches) On State highways Use 72 X 36 inches	(0.75 or ¾ miles)	13
Type C or I – High speed, high volume motor vehicle traffic control projects	(96 X 48 inches)	(1 mile)	15
Type D – for use on authorized vehicles	None	0.5 or 1/5 mile	12

Flagger Reference Information

1599 TRAINING OF CONSTRUCTION SITE FLAGGERS
Effective August 22, 2009

- (a) Flaggers shall be utilized at locations on a construction site where barricades and warning signs cannot control the moving traffic.
- (b) When flaggers are required, they shall be placed in relation to the equipment or operation so as to give effective warning.
- (c) Placement of warning signs shall be according to the California Manual on Uniform Traffic Control Devices for Streets and Highways, September 26, 2006, published by the State Department of Transportation, which is herein incorporated by reference and referred to as the "Manual."
- (d) Flaggers shall wear warning garments such as vests, jackets, or shirts manufactured in accordance with the requirements of the American National Standards Institute (ANSI)/International Safety Equipment Association (ISEA) 107-2004, High Visibility Safety Apparel and Headwear.
- (e) During the hours of darkness, flaggers' stations shall be illuminated such that the flagger will be clearly visible to approaching traffic and flaggers shall be outfitted with reflectorized garments manufactured in accordance with the requirements of the American National Standards Institute (ANSI)/ International Safety Equipment Association (ISEA) 107-2004, High Visibility Safety Apparel and Headwear. The retroreflective material shall be visible at a minimum distance of 1,000 feet. White outer garments with retroreflective material that meets the above requirements may be worn during hours of darkness but not during snow or fog conditions, in lieu of colored vests, jackets and/or shirts.
- (f) The employer shall select the proper type (class) of high visibility safety apparel for a given occupational activity by consulting the Manual, apparel manufacturer, ANSI/ISEA 107-2004, Appendix B or the American Traffic Safety Services Association (ATSSA).

(g) Flaggers shall be trained in the proper fundamentals of flagging moving traffic before being assigned as flaggers. Signaling directions used by flaggers shall conform to the "Manual" (CA MUTCD). The training and instructions shall be based on the "Manual" (CA MUTCD) and work site conditions and also include the following:

- (1) flagger equipment which must be used,
- (2) layout of the work zone and flagging station,
- (3) methods to signal traffic to stop, proceed or slow down,
- (4) methods of one-way traffic control,
- (5) trainee demonstration of proper flagging methodology and operations,
- (6) emergency vehicles traveling through the work zone,
- (7) handling emergency situations,
- (8) methods of dealing with hostile drivers,
- (9) flagging procedures when a single flagger is used (when applicable)

Documentation of the training shall be maintained as required by Section 3203, Injury Illness and Prevention Program of the General Industry Safety Orders.

(h) flaggers shall be trained by persons with the qualifications and experience necessary to effectively instruct the employee in the proper fundamentals of flagging moving traffic.

Note: Authority cited: 142.3, Labor Code. Reference: Section 142.3, Labor Code.

California MUTCD Section 6E.04 Flagger Procedures:

Support:

The use of paddles and flags by flaggers is illustrated in Figure 6E-1 (see page 27).

Standard:

The following methods of signaling with paddles shall be used:

- A. To stop road users, the flagger shall face road users and aim the STOP paddle face toward road users in a stationary position with the arm extended horizontally away from the body. The free arm shall be held with the palm of the hand above shoulder level toward approaching traffic.**
- B. To direct stopped road users to proceed, the flagger shall face road users with the SLOW paddle face aimed toward road users in a stationary position with the arm extended horizontally away from the body. The flagger shall motion with the free hand for road users to proceed.**
- C. To alert or slow traffic, the flagger shall face road users with the SLOW paddle face aimed toward road users in a stationary position with the arm extended horizontally away from the body.**

Option:

To further alert or slow traffic, the flagger holding the SLOW paddle face toward road users may motion up and down with the free hand, palm down.

Standard:

The following methods of signaling with a flag shall be used:

- A. To stop road users, the flagger shall face road users and extend the flag staff horizontally across the road users' lane in a stationary position so that the full area of the flag is visibly hanging below the staff. The free arm shall be held with the palm of the hand above the shoulder level toward approaching traffic.
- B. To direct stopped road users to proceed, the flagger shall stand parallel to the road user movement and with flag and arm lowered from the view of the road users, and shall motion with the free hand for road users to proceed. Flags shall not be used to signal road users to proceed.
- C. To alert or slow traffic, the flagger shall face road users and slowly wave the flag in a sweeping motion of the extended arm from shoulder level to straight down without raising the arm above a horizontal position. The flagger shall keep the free hand down.

Section 6E.05 Flagger Stations

Standard:

Flagger stations shall be located such that approaching road users will have sufficient distance to stop at an intended stopping point.

Guidance:

Flagger stations should be located such that an errant vehicle has additional space to stop without entering the work space.

Standard:

Except in emergency situations, flagger stations shall be preceded by an advance warning sign or signs. Except in emergency situations, flagger stations shall be illuminated at night.

CA MUTCD Figure 6E-1. Use of Hand Signaling Devices by Flaggers

PREFERRED METHOD
STOP/SLOW Paddle

EMERGENCY SITUATIONS ONLY
Red Flag

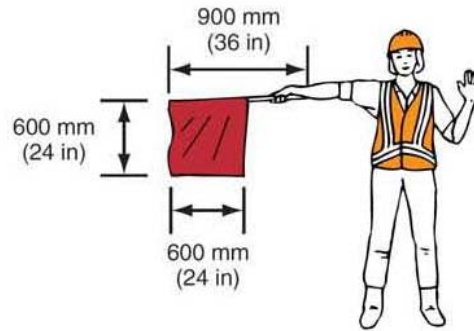

TO STOP TRAFFIC



TO LET TRAFFIC PROCEED



TO ALERT AND SLOW TRAFFIC

REFERENCE SIGN CHART

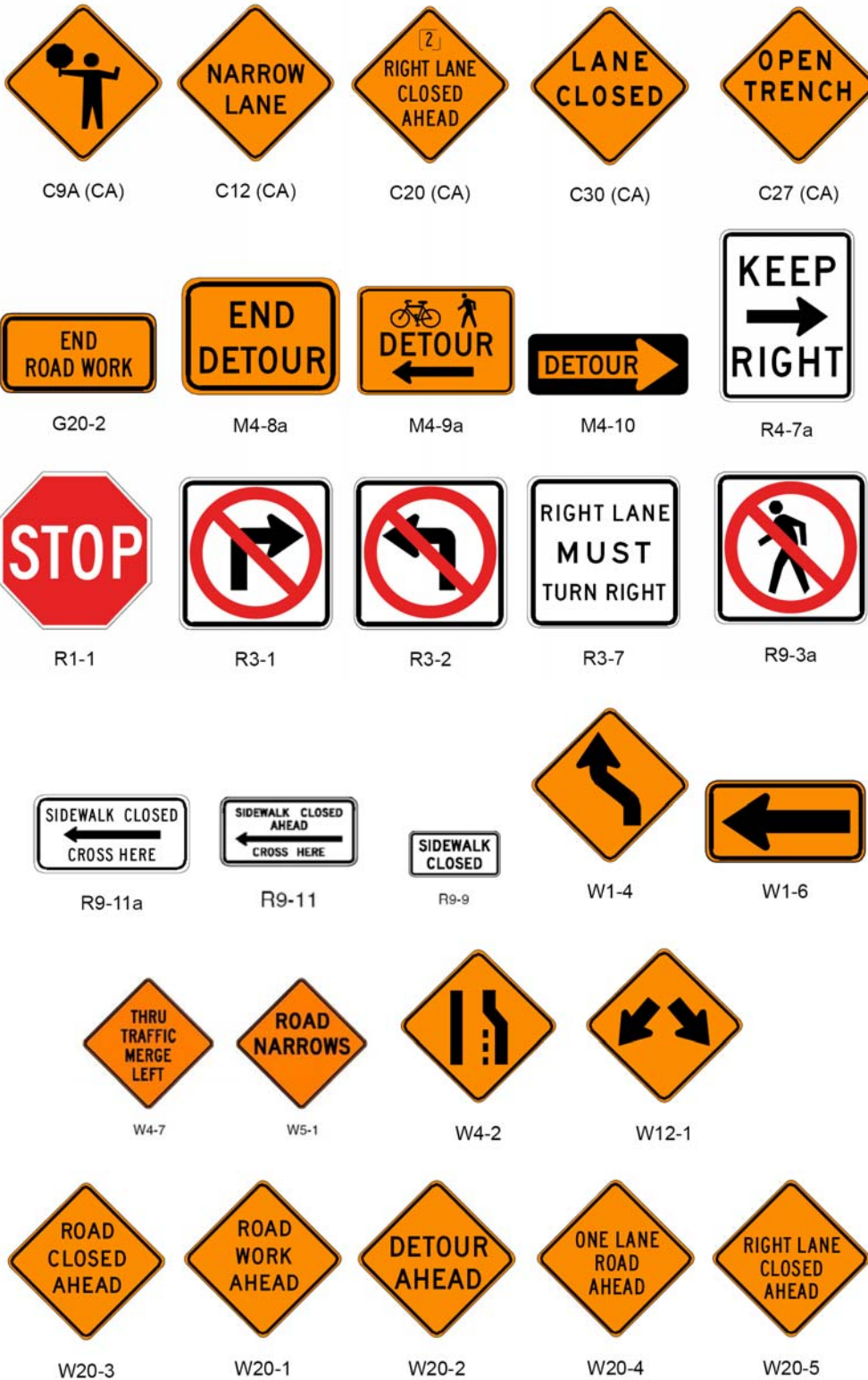

REFERENCE SIGN CHART

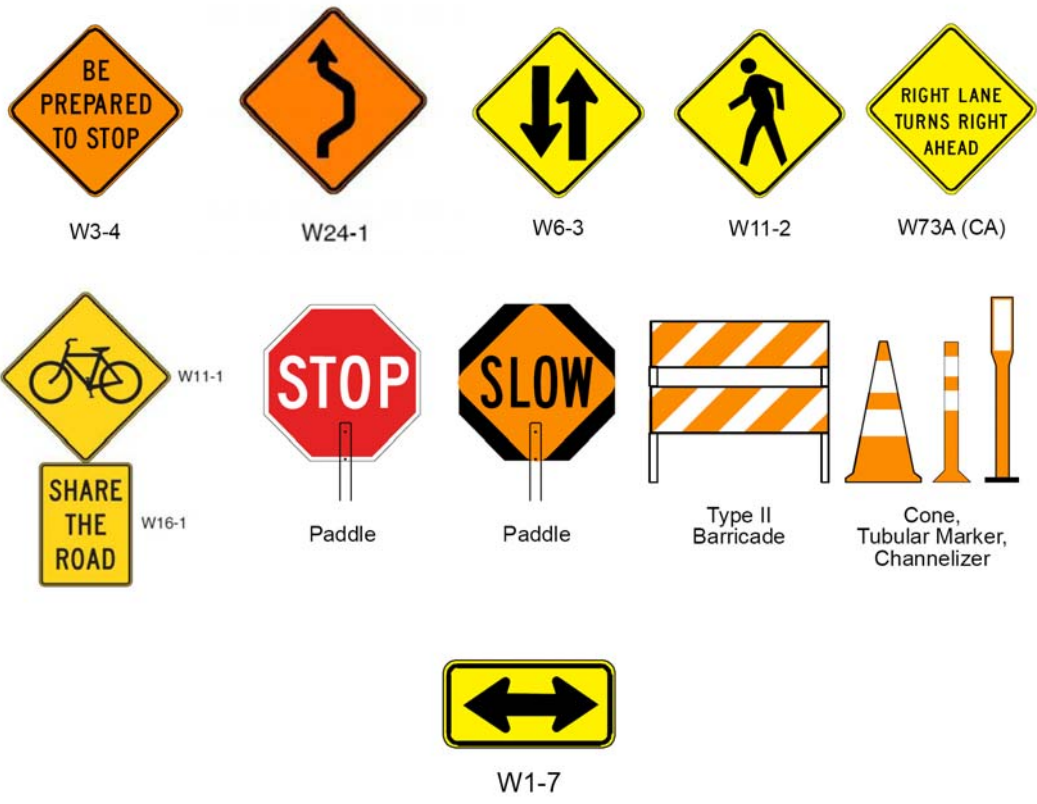

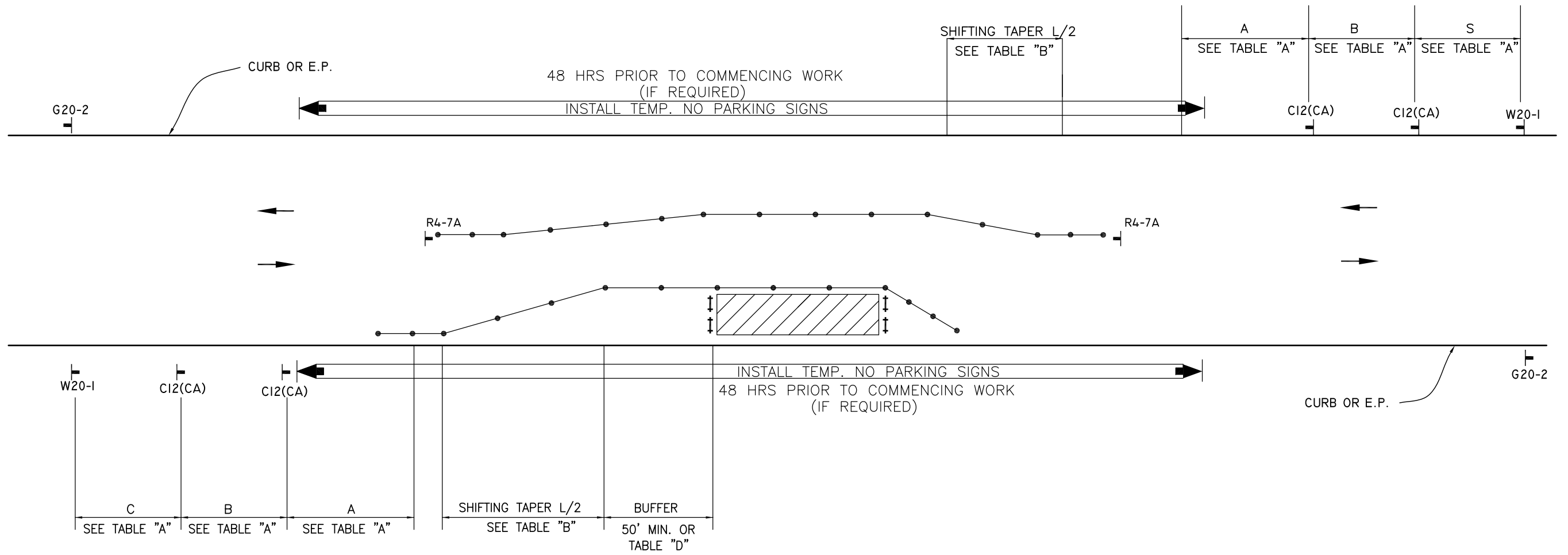

LEGEND

- TYPE III BARRICADE W/SIGN
- TYPE II BARRICADE W/O SIGN
- CHANNELIZING DEVICE
- TRAFFIC CONE WITH CLIP ON SIGN
- SIGN
- SIGNALIZED INTERSECTION
- ARROW PANEL (FLASHING ARROW) (WHERE REQUIRED)
- HIGH LEVEL WARNING DEVICE (FLAGTREE) (OPTIONAL)
- FLAGGER
- TANS TOW AWAY NO STOPPING ____ TO ____ (SHOW HOURS)
- TANSAT TOW AWAY NO STOPPING ANY TIME
- WORK ZONE (ACTIVITY AREA) LIMITS
- DIRECTION OF TRAFFIC (NOT PAVEMENT MARKING)
- ROADWAY DESIGNATION (A THROUGH D)

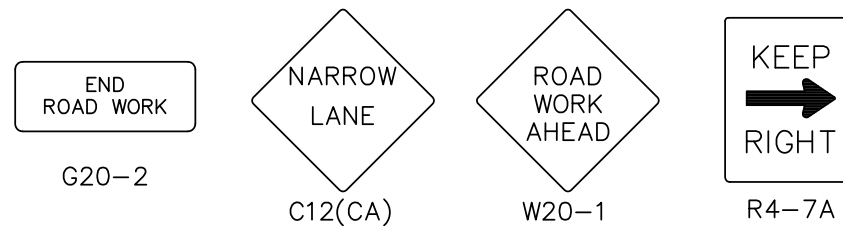

DATES OF TEMPORARY NO PARKING ZONE _____

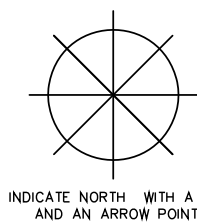

WORKSITE TRAFFIC CONTROL PLAN		
SIDE OF ROAD WORK TWO LANE TRAFFIC CONTROL WITHOUT CENTERLINE		
DATE		SCALE
		NONE
		DRAWING NO. 1



CONSTRUCTION NOTE:
ALL DRIVEWAYS TO REMAIN OPEN (WHENEVER POSSIBLE) THROUGHOUT TRAFFIC CONTROL ZONE

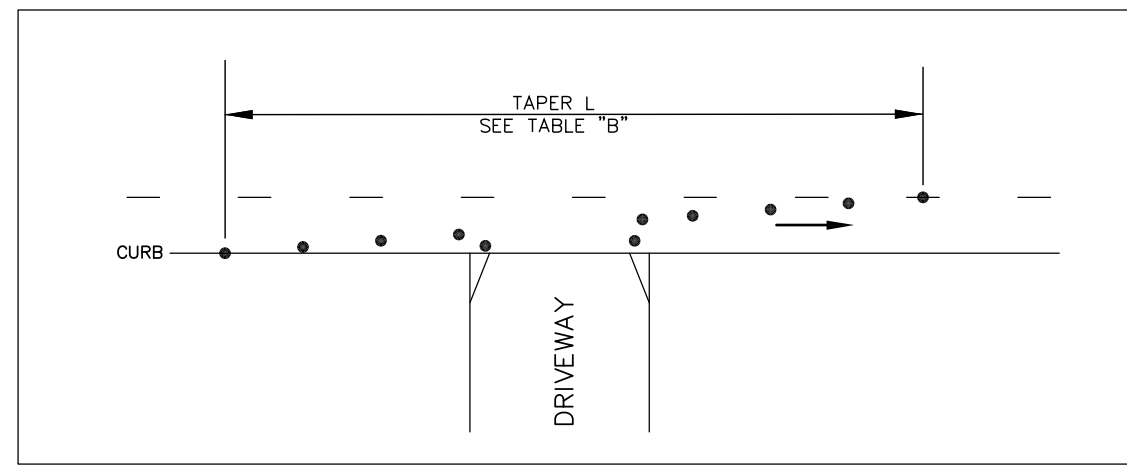

SEE TABLE 'A'-'F' FOR SIGN AND CHANNELIZER DEVICE SPACING AND TAPER LENGTH

SPEED	APPROACH STREET	TAPER LENGTH	SIGN SPACING	CHANNELIZER SPACING

SEE TABLE 'A'-'F' FOR SIGN AND CHANNELIZER DEVICE SPACING AND TAPER LENGTH

SPEED	APPROACH STREET	TAPER LENGTH	SIGN SPACING	CHANNELIZER SPACING

ABBREVIATIONS:

- S = Sign Spacing
- Min = Minimum
- LT = Left
- RT = Right
- LTP = Lane Traffic Panel
- TANSAT = Tow Away, No Stopping Anytime
- TANS = Tow Away, No Stopping

— CHART A —
MINIMUM RECOMMENDED DELINEATOR/CONE & SIGN PLACEMENT

POSTED SPEED LIMIT	TAPER LENGTH FOR 12-FT LANE			CHANNELIZER SPACING		SIGN SPACING (ADVANCE OF TAPER & BETWEEN SIGNS)
	MERGING	SHIFTING	SHOULDER	TAPER	TANGENT	
20 MPH	80 FT.	40 FT.	27 FT.	20 FT.	40 FT.	100 FT.
25 MPH	125 FT.	63 FT.	42 FT.	25 FT.	63 FT.	100 FT.
30 MPH	180 FT.	90 FT.	60 FT.	30 FT.	90 FT.	350 FT.
35 MPH	245 FT.	123 FT.	82 FT.	35 FT.	123 FT.	350 FT.
40 MPH	320 FT.	160 FT.	107 FT.	40 FT.	160 FT.	350 FT.
* 45 MPH	540 FT.	270 FT.	180 FT.	45 FT.	270 FT.	500 FT.
* 50 MPH	600 FT.	300 FT.	200 FT.	50 FT.	300 FT.	500 FT.
* 55+MPH	660 FT.	330 FT.	220 FT.	55 FT.	330 FT.	PER TABLE 'A'

NOTES

1. A Flashing Arrow sign shall be used for each lane closed.
- *2. Two lane closure signs (C-20) shall be used on the approach to a lane closure with speeds of 45 mph or greater.

NOTE: This chart based on 12-foot wide lanes.

For lane widths greater than 12 feet, use the following formulae:

Taper formula:

$$L = S \times W \text{ for speeds of 45 mph or more.}$$

$$L = \frac{WS^2}{60} \text{ for speeds of 40 mph or less.}$$

Where:

L = Minimum length of taper.

S = Numerical value of posted speed limit prior to work or 85 percentile speed.

W = Width of offset.

i.e.: 50 mph and 19' lane; $L = 50 \times 19 = 950$ feet

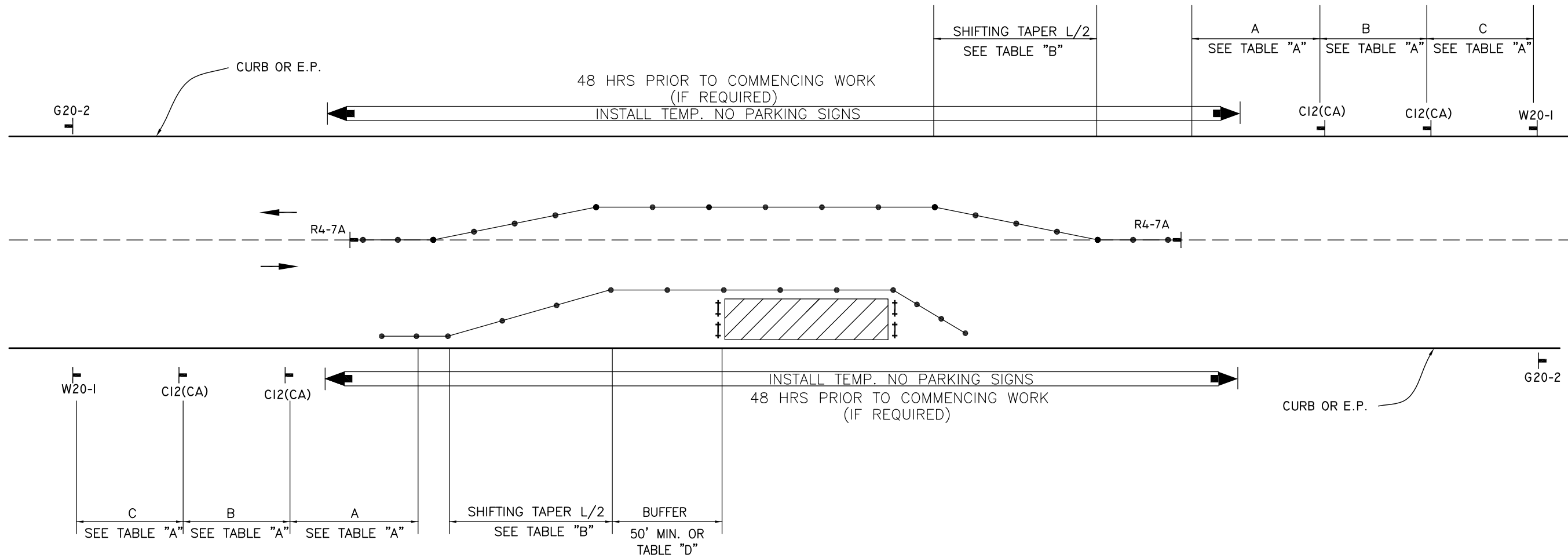

LEGEND

- TYPE III BARRICADE W/SIGN
- TYPE II BARRICADE W/O SIGN
- CHANNELIZING DEVICE
- TRAFFIC CONE WITH CLIP ON SIGN
- SIGN
- SIGNALIZED INTERSECTION
- ARROW PANEL (FLASHING ARROW) (WHERE REQUIRED)
- HIGH LEVEL WARNING DEVICE (FLAGTREE) (OPTIONAL)
- FLAGGER
- TANS TOW AWAY NO STOPPING ____ TO ____ (SHOW HOURS)
- TANSAT TOW AWAY NO STOPPING ANY TIME
- WORK ZONE (ACTIVITY AREA) LIMITS
- DIRECTION OF TRAFFIC (NOT PAVEMENT MARKING)
- ROADWAY DESIGNATION (A THROUGH D)

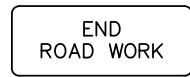

G20-2



C12(CA)



W20-1

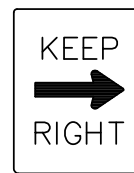

R4-7A

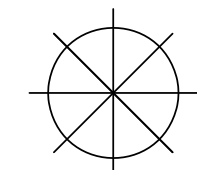

INDICATE NORTH WITH A "N" AND AN ARROW POINT

DATES OF TEMPORARY NO PARKING ZONE _____

WORKSITE TRAFFIC CONTROL PLAN
 CENTER OF ROAD WORK AREA
 TWO LANE TRAFFIC CONTROL

DATE		SCALE	NONE
		DRAWING NO.	2



CONSTRUCTION NOTE:
ALL DRIVEWAYS TO REMAIN OPEN (WHENEVER POSSIBLE) THROUGHOUT TRAFFIC CONTROL ZONE



SEE TABLE 'A'-'F' FOR SIGN AND CHANNELIZER DEVICE SPACING AND TAPER LENGTH

SPEED	APPROACH STREET	TAPER LENGTH	SIGN SPACING	CHANNELIZER SPACING

SEE TABLE 'A'-'F' FOR SIGN AND CHANNELIZER DEVICE SPACING AND TAPER LENGTH

SPEED	APPROACH STREET	TAPER LENGTH	SIGN SPACING	CHANNELIZER SPACING

ABBREVIATIONS:

- S = Sign Spacing
- Min = Minimum
- LT = Left
- RT = Right
- LTP = Lane Traffic Panel
- TANSAT = Tow Away, No Stopping Anytime
- TANS = Tow Away, No Stopping

— CHART A —
MINIMUM RECOMMENDED DELINEATOR/CONE & SIGN PLACEMENT

POSTED SPEED LIMIT	TAPER LENGTH FOR 12-FT LANE			CHANNELIZER SPACING		SIGN SPACING (ADVANCE OF TAPER & BETWEEN SIGNS)
	MERGING	SHIFTING	SHOULDER	TAPER	TANGENT	
20 MPH	80 FT.	40 FT.	27 FT.	20 FT.	40 FT.	100 FT.
25 MPH	125 FT.	63 FT.	42 FT.	25 FT.	63 FT.	100 FT.
30 MPH	180 FT.	90 FT.	60 FT.	30 FT.	90 FT.	350 FT.
35 MPH	245 FT.	123 FT.	82 FT.	35 FT.	123 FT.	350 FT.
40 MPH	320 FT.	160 FT.	107 FT.	40 FT.	160 FT.	350 FT.
* 45 MPH	540 FT.	270 FT.	180 FT.	45 FT.	270 FT.	500 FT.
* 50 MPH	600 FT.	300 FT.	200 FT.	50 FT.	300 FT.	500 FT.
* 55+MPH	660 FT.	330 FT.	220 FT.	55 FT.	330 FT.	PER TABLE 'A'

NOTES

1. A Flashing Arrow sign shall be used for each lane closed.
- *2. Two lane closure signs (C-20) shall be used on the approach to a lane closure with speeds of 45 mph or greater.

NOTE: This chart based on 12-foot wide lanes.

For lane widths greater than 12 feet, use the following formulae:

Taper formula:

$$L = S \times W \text{ for speeds of 45 mph or more.}$$

$$L = \frac{WS^2}{60} \text{ for speeds of 40 mph or less.}$$

Where:

L = Minimum length of taper.

S = Numerical value of posted speed limit prior to work or 85 percentile speed.

W = Width of offset.

i.e.: 50 mph and 19' lane; $L = 50 \times 19 = 950$ feet

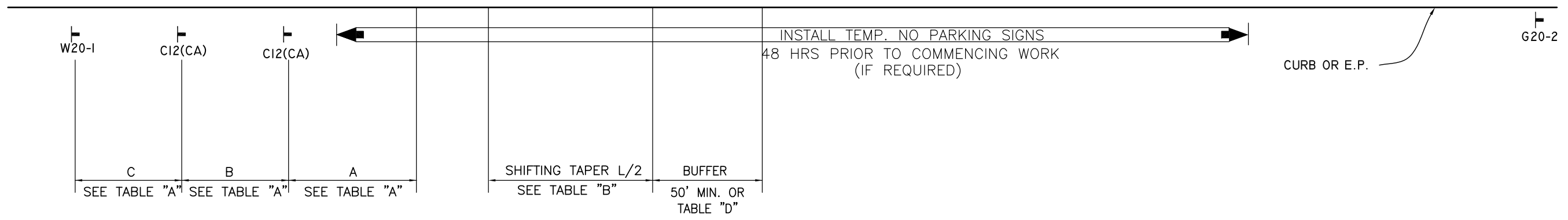
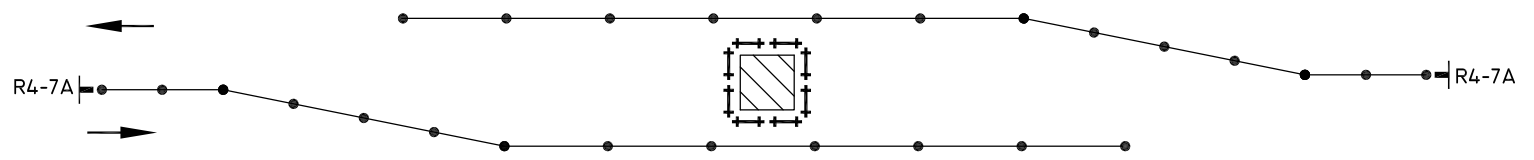
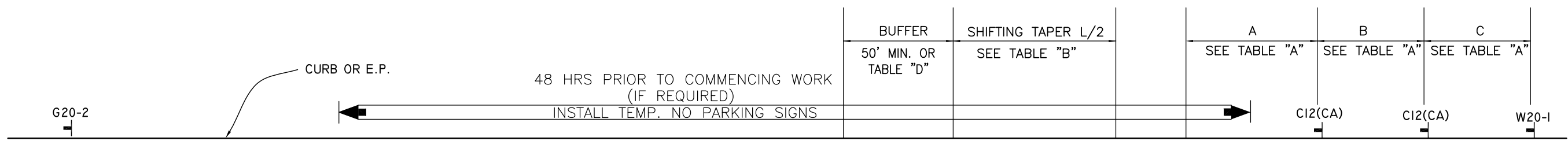

LEGEND

- TYPE III BARRICADE W/SIGN
- TYPE II BARRICADE W/O SIGN
- CHANNELIZING DEVICE
- TRAFFIC CONE WITH CLIP ON SIGN
- SIGN
- SIGNALIZED INTERSECTION
- ARROW PANEL (FLASHING ARROW) (WHERE REQUIRED)
- HIGH LEVEL WARNING DEVICE (FLAGTREE) (OPTIONAL)
- FLAGGER
- TANS TOW AWAY NO STOPPING ____ TO ____ (SHOW HOURS)
- TANSAT TOW AWAY NO STOPPING ANY TIME
- WORK ZONE (ACTIVITY AREA) LIMITS
- DIRECTION OF TRAFFIC (NOT PAVEMENT MARKING)
- ROADWAY DESIGNATION (A THROUGH D)

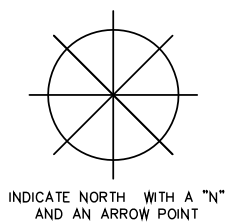
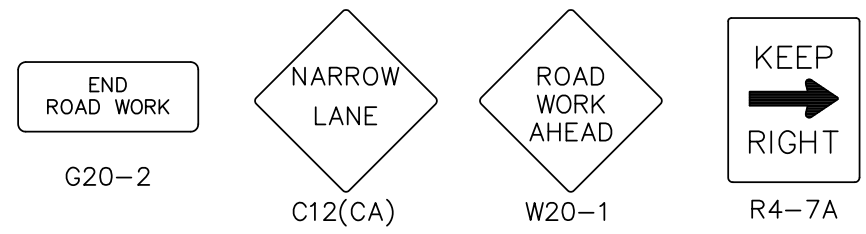

DATES OF TEMPORARY NO PARKING ZONE _____

WORKSITE TRAFFIC CONTROL PLAN WORK IN CENTER OF ROAD TWO LANE TRAFFIC CONTROL		
DATE		SCALE
		NONE
		DRAWING NO. 3

REV. APR-2010 C:\JUTCM-DWG03.DWG



CONSTRUCTION NOTE:
ALL DRIVEWAYS TO REMAIN OPEN (WHENEVER POSSIBLE) THROUGHOUT TRAFFIC CONTROL ZONE



SEE TABLE 'A'-'F' FOR SIGN AND CHANNELIZER DEVICE SPACING AND TAPER LENGTH

SPEED	APPROACH STREET	TAPER LENGTH	SIGN SPACING	CHANNELIZER SPACING

SEE TABLE 'A'-'F' FOR SIGN AND CHANNELIZER DEVICE SPACING AND TAPER LENGTH

SPEED	APPROACH STREET	TAPER LENGTH	SIGN SPACING	CHANNELIZER SPACING

ABBREVIATIONS:

- S = Sign Spacing
- Min = Minimum
- LT = Left
- RT = Right
- LTP = Lane Traffic Panel
- TANSAT = Tow Away, No Stopping Anytime
- TANS = Tow Away, No Stopping

— CHART A —
MINIMUM RECOMMENDED DELINEATOR/CONE & SIGN PLACEMENT

POSTED SPEED LIMIT	TAPER LENGTH FOR 12-FT LANE			CHANNELIZER SPACING		SIGN SPACING (ADVANCE OF TAPER & BETWEEN SIGNS)
	MERGING	SHIFTING	SHOULDER	TAPER	TANGENT	
20 MPH	80 FT.	40 FT.	27 FT.	20 FT.	40 FT.	100 FT.
25 MPH	125 FT.	63 FT.	42 FT.	25 FT.	63 FT.	100 FT.
30 MPH	180 FT.	90 FT.	60 FT.	30 FT.	90 FT.	350 FT.
35 MPH	245 FT.	123 FT.	82 FT.	35 FT.	123 FT.	350 FT.
40 MPH	320 FT.	160 FT.	107 FT.	40 FT.	160 FT.	350 FT.
* 45 MPH	540 FT.	270 FT.	180 FT.	45 FT.	270 FT.	500 FT.
* 50 MPH	600 FT.	300 FT.	200 FT.	50 FT.	300 FT.	500 FT.
* 55+MPH	660 FT.	330 FT.	220 FT.	55 FT.	330 FT.	PER TABLE 'A'

NOTES

1. A Flashing Arrow sign shall be used for each lane closed.
- *2. Two lane closure signs (C-20) shall be used on the approach to a lane closure with speeds of 45 mph or greater.

NOTE: This chart based on 12-foot wide lanes.

For lane widths greater than 12 feet, use the following formulae:

Taper formula:

$$L = S \times W \text{ for speeds of 45 mph or more.}$$

$$L = \frac{WS^2}{60} \text{ for speeds of 40 mph or less.}$$

Where:

L = Minimum length of taper.

S = Numerical value of posted speed limit prior to work or 85 percentile speed.

W = Width of offset.

i.e.: 50 mph and 19' lane; $L = 50 \times 19 = 950$ feet

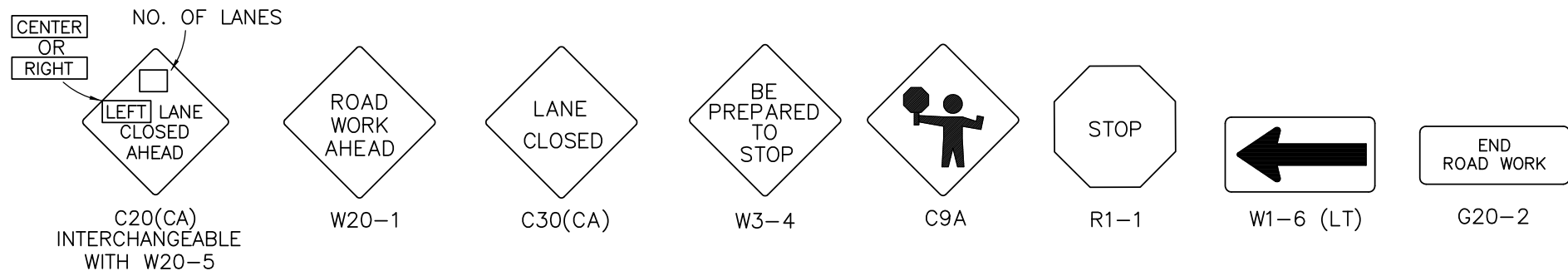
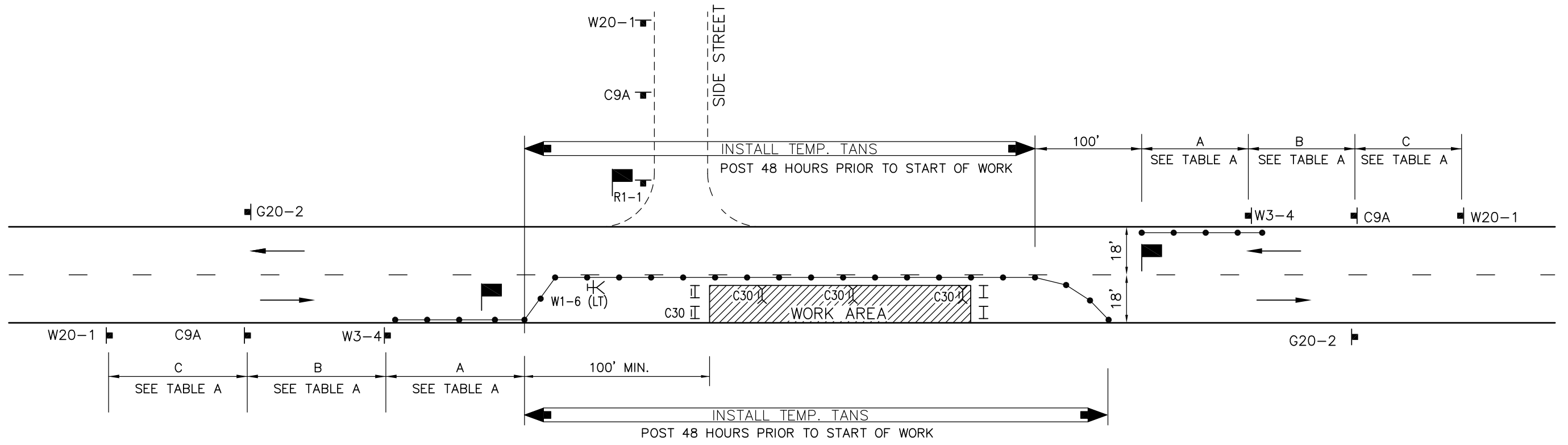

LEGEND

- TYPE III BARRICADE W/SIGN
- TYPE II BARRICADE W/O SIGN
- CHANNELIZING DEVICE
- TRAFFIC CONE WITH CLIP ON SIGN
- SIGN
- SIGNALIZED INTERSECTION
- ARROW PANEL (FLASHING ARROW) (WHERE REQUIRED)
- HIGH LEVEL WARNING DEVICE (FLAGTREE) (OPTIONAL)
- FLAGGER
- TANS TOW AWAY NO STOPPING ____ TO ____ (SHOW HOURS)
- TANSAT TOW AWAY NO STOPPING ANY TIME
- WORK ZONE (ACTIVITY AREA) LIMITS
- DIRECTION OF TRAFFIC (NOT PAVEMENT MARKING)
- ROADWAY DESIGNATION (A THROUGH D)

DATES OF TEMPORARY NO PARKING ZONE _____

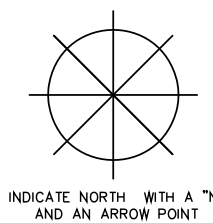

WORKSITE TRAFFIC CONTROL PLAN		
MIDBLOCK HALF STREET CLOSURE		
FLAGGER CONTROL		
DATE		SCALE
		NONE
		DRAWING NO. 4

REV. APR-2010 C:\JUTCM-DWG04.DWG



CONSTRUCTION NOTE:
ALL DRIVEWAYS TO REMAIN OPEN (WHENEVER POSSIBLE) THROUGHOUT TRAFFIC CONTROL ZONE



SEE TABLE 'A'-'F' FOR SIGN AND CHANNELIZER DEVICE SPACING AND TAPER LENGTH

SPEED	APPROACH STREET	TAPER LENGTH	SIGN SPACING	CHANNELIZER SPACING

SEE TABLE 'A'-'F' FOR SIGN AND CHANNELIZER DEVICE SPACING AND TAPER LENGTH

SPEED	APPROACH STREET	TAPER LENGTH	SIGN SPACING	CHANNELIZER SPACING

ABBREVIATIONS:

- S = Sign Spacing
- Min = Minimum
- LT = Left
- RT = Right
- LTP = Lane Traffic Panel
- TANSAT = Tow Away, No Stopping Anytime
- TANS = Tow Away, No Stopping

— CHART A —
MINIMUM RECOMMENDED DELINEATOR/CONE & SIGN PLACEMENT

POSTED SPEED LIMIT	TAPER LENGTH FOR 12-FT LANE			CHANNELIZER SPACING		SIGN SPACING (ADVANCE OF TAPER & BETWEEN SIGNS)
	MERGING	SHIFTING	SHOULDER	TAPER	TANGENT	
20 MPH	80 FT.	40 FT.	27 FT.	20 FT.	40 FT.	100 FT.
25 MPH	125 FT.	63 FT.	42 FT.	25 FT.	63 FT.	100 FT.
30 MPH	180 FT.	90 FT.	60 FT.	30 FT.	90 FT.	350 FT.
35 MPH	245 FT.	123 FT.	82 FT.	35 FT.	123 FT.	350 FT.
40 MPH	320 FT.	160 FT.	107 FT.	40 FT.	160 FT.	350 FT.
* 45 MPH	540 FT.	270 FT.	180 FT.	45 FT.	270 FT.	500 FT.
* 50 MPH	600 FT.	300 FT.	200 FT.	50 FT.	300 FT.	500 FT.
* 55+MPH	660 FT.	330 FT.	220 FT.	55 FT.	330 FT.	PER TABLE 'A'

NOTES

1. A Flashing Arrow sign shall be used for each lane closed.
- *2. Two lane closure signs (C-20) shall be used on the approach to a lane closure with speeds of 45 mph or greater.

NOTE: This chart based on 12-foot wide lanes.

For lane widths greater than 12 feet, use the following formulae:

Taper formula:

$$L = S \times W \text{ for speeds of 45 mph or more.}$$

$$L = \frac{WS^2}{60} \text{ for speeds of 40 mph or less.}$$

Where:

L = Minimum length of taper.

S = Numerical value of posted speed limit prior to work or 85 percentile speed.

W = Width of offset.

i.e.: 50 mph and 19' lane; $L = 50 \times 19 = 950$ feet

REV. APR-2010 C:\JUTCM-DWG50.DWG

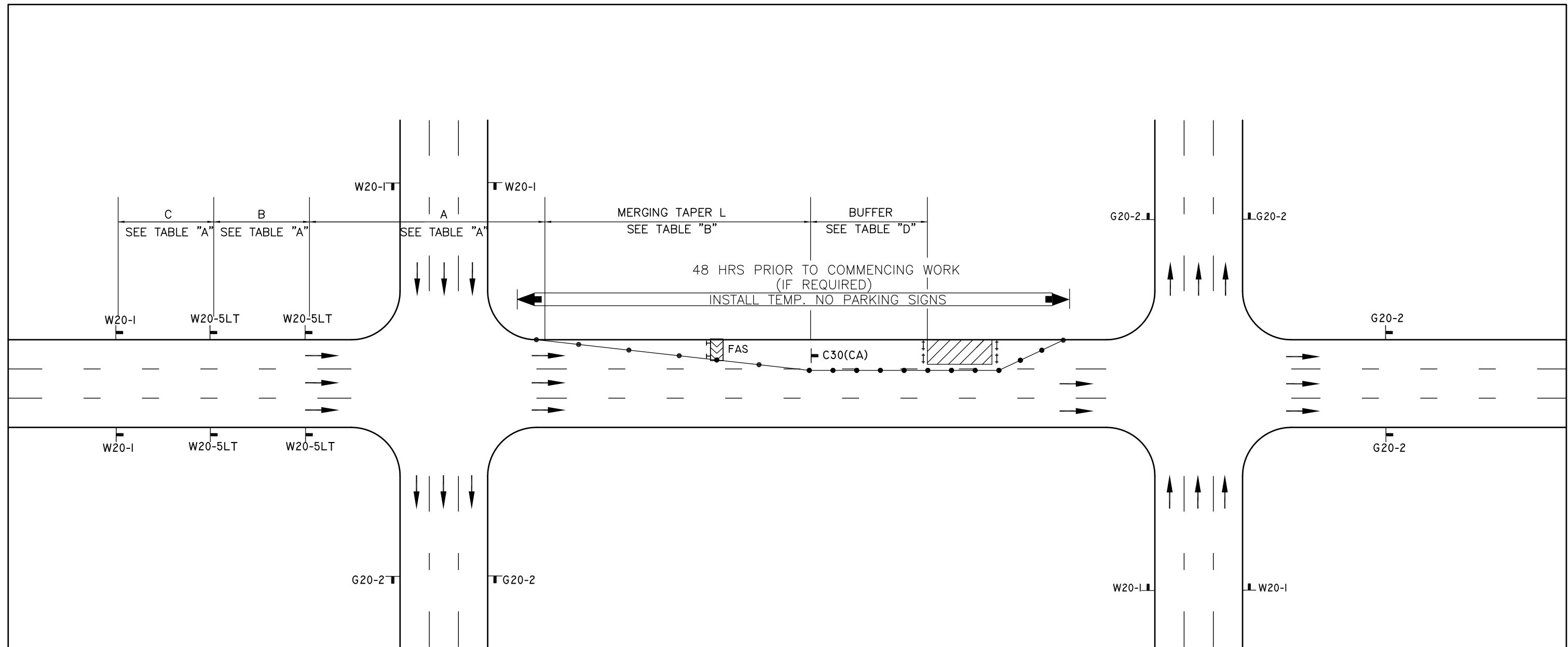

LEGEND

- TYPE III BARRICADE W/SIGN
- TYPE II BARRICADE W/O SIGN
- CHANNELIZING DEVICE
- TRAFFIC CONE WITH CLIP ON SIGN
- SIGN
- SIGNALIZED INTERSECTION
- ARROW PANEL (FLASHING ARROW) (WHERE REQUIRED)
- HIGH LEVEL WARNING DEVICE (FLAGTREE) (OPTIONAL)
- FLAGGER
- TANS TOW AWAY NO STOPPING ____ TO ____ (SHOW HOURS)
- TANSAT TOW AWAY NO STOPPING ANY TIME
- WORK ZONE (ACTIVITY AREA) LIMITS
- DIRECTION OF TRAFFIC (NOT PAVEMENT MARKING)
- ROADWAY DESIGNATION (A THROUGH D)

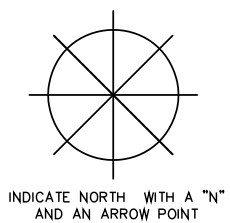
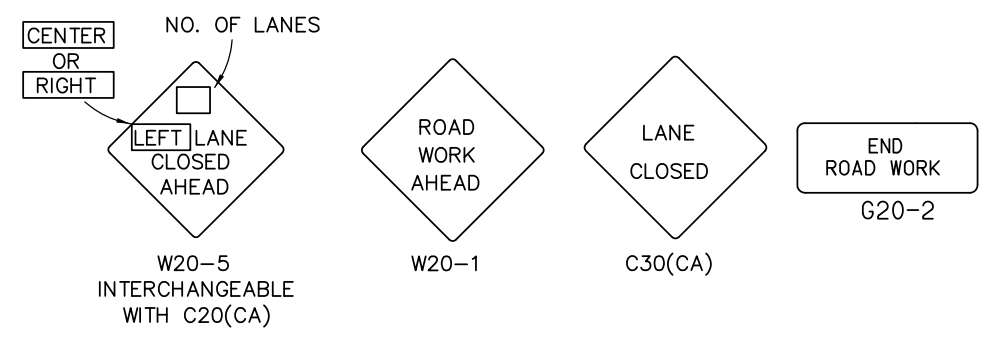

DATES OF TEMPORARY NO PARKING ZONE _____

WORKSITE TRAFFIC CONTROL PLAN		
SIDE OF ROAD WORK AREA SINGLE LANE CLOSURE FOR ONE WAY STREET		
DATE		SCALE
		NONE
		DRAWING NO. 5



CONSTRUCTION NOTE:
 ALL DRIVEWAYS TO REMAIN OPEN (WHENEVER POSSIBLE) THROUGHOUT TRAFFIC CONTROL ZONE

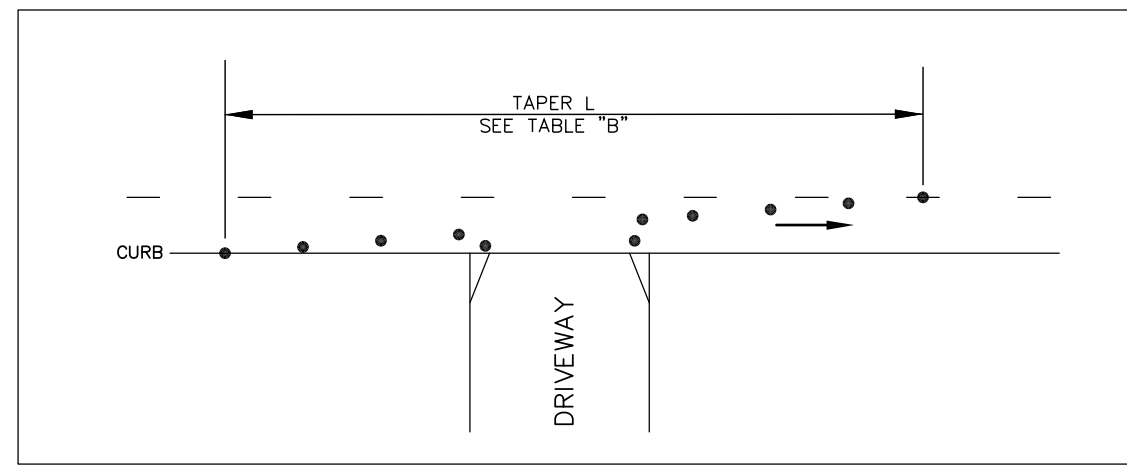

SEE TABLE 'A'-'F' FOR SIGN AND CHANNELIZER DEVICE SPACING AND TAPER LENGTH

SPEED	APPROACH STREET	TAPER LENGTH	SIGN SPACING	CHANNELIZER SPACING

SEE TABLE 'A'-'F' FOR SIGN AND CHANNELIZER DEVICE SPACING AND TAPER LENGTH

SPEED	APPROACH STREET	TAPER LENGTH	SIGN SPACING	CHANNELIZER SPACING

ABBREVIATIONS:

- S = Sign Spacing
- Min = Minimum
- LT = Left
- RT = Right
- LTP = Lane Traffic Panel
- TANSAT = Tow Away, No Stopping Anytime
- TANS = Tow Away, No Stopping

— CHART A —
 MINIMUM RECOMMENDED DELINEATOR/CONE & SIGN PLACEMENT

POSTED SPEED LIMIT	TAPER LENGTH FOR 12-FT LANE			CHANNELIZER SPACING		SIGN SPACING (ADVANCE OF TAPER & BETWEEN SIGNS)
	MERGING	SHIFTING	SHOULDER	TAPER	TANGENT	
20 MPH	80 FT.	40 FT.	27 FT.	20 FT.	40 FT.	100 FT.
25 MPH	125 FT.	63 FT.	42 FT.	25 FT.	63 FT.	100 FT.
30 MPH	180 FT.	90 FT.	60 FT.	30 FT.	90 FT.	350 FT.
35 MPH	245 FT.	123 FT.	82 FT.	35 FT.	123 FT.	350 FT.
40 MPH	320 FT.	160 FT.	107 FT.	40 FT.	160 FT.	350 FT.
* 45 MPH	540 FT.	270 FT.	180 FT.	45 FT.	270 FT.	500 FT.
* 50 MPH	600 FT.	300 FT.	200 FT.	50 FT.	300 FT.	500 FT.
* 55+MPH	660 FT.	330 FT.	220 FT.	55 FT.	330 FT.	PER TABLE 'A'

NOTES

1. A Flashing Arrow sign shall be used for each lane closed.
- *2. Two lane closure signs (C-20) shall be used on the approach to a lane closure with speeds of 45 mph or greater.

NOTE: This chart based on 12-foot wide lanes.

For lane widths greater than 12 feet, use the following formulae:

Taper formula:

$$L = S \times W \text{ for speeds of 45 mph or more.}$$

$$L = \frac{WS^2}{60} \text{ for speeds of 40 mph or less.}$$

Where:

L = Minimum length of taper.

S = Numerical value of posted speed limit prior to work or 85 percentile speed.

W = Width of offset.

i.e.: 50 mph and 19' lane; $L = 50 \times 19 = 950$ feet

REV. APR-2010 C:\JUTCM-DWG06.DWG

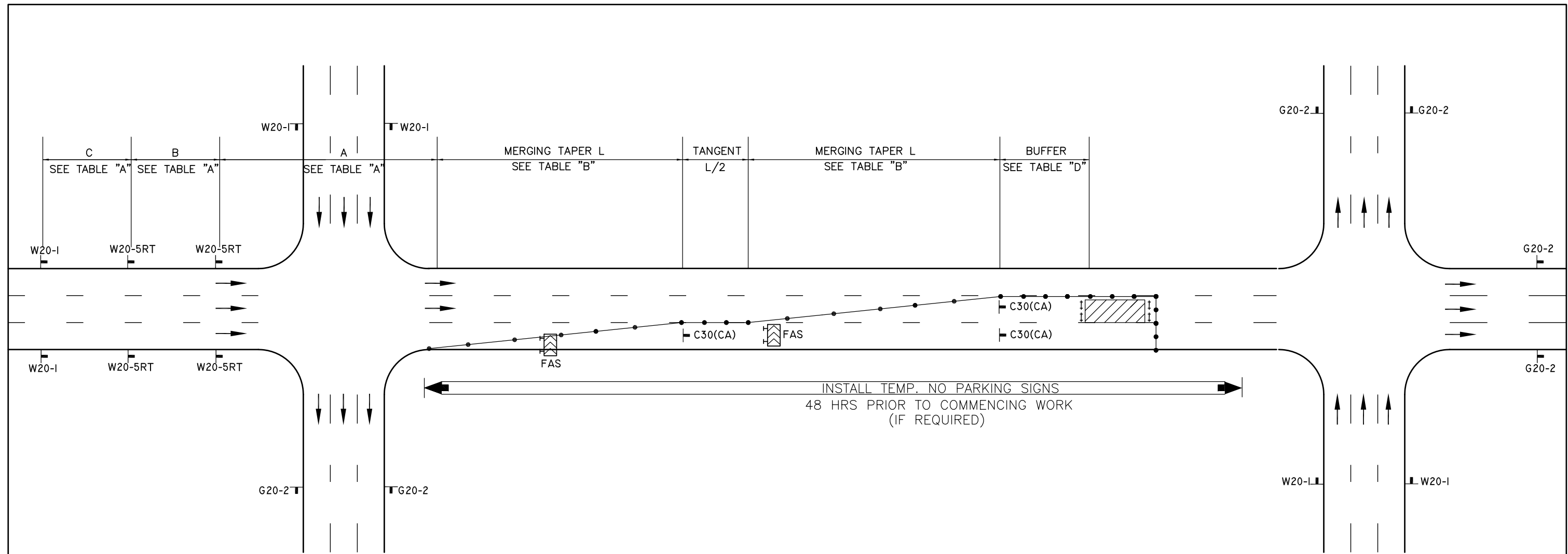

LEGEND

- TYPE III BARRICADE W/SIGN
- TYPE II BARRICADE W/O SIGN
- CHANNELIZING DEVICE
- TRAFFIC CONE WITH CLIP ON SIGN
- SIGN
- SIGNALIZED INTERSECTION
- ARROW PANEL (FLASHING ARROW) (WHERE REQUIRED)
- HIGH LEVEL WARNING DEVICE (FLAGTREE) (OPTIONAL)
- FLAGGER
- TANS TOW AWAY NO STOPPING ____ TO ____ (SHOW HOURS)
- TANSAT TOW AWAY NO STOPPING ANY TIME
- WORK ZONE (ACTIVITY AREA) LIMITS
- DIRECTION OF TRAFFIC (NOT PAVEMENT MARKING)
- ROADWAY DESIGNATION (A THROUGH D)

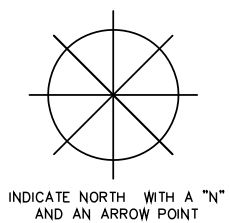
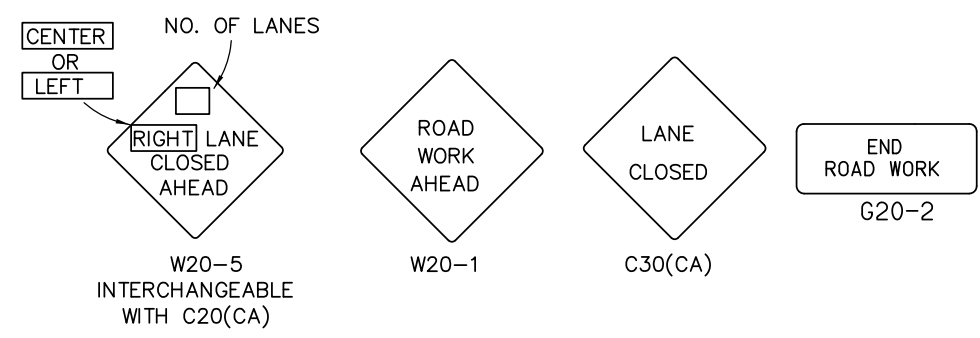

DATES OF TEMPORARY NO PARKING ZONE _____

WORKSITE TRAFFIC CONTROL PLAN
 SIDE OF ROAD WORK AREA
 MULTILANE CLOSURE FOR ONE WAY STREET
 RIGHT TRAFFIC LANES CLOSED—ONE LANE

DATE		SCALE	NONE
		DRAWING NO.	6



CONSTRUCTION NOTE:
 ALL DRIVEWAYS TO REMAIN OPEN (WHENEVER POSSIBLE) THROUGHOUT TRAFFIC CONTROL ZONE



SEE TABLE 'A'-'F' FOR SIGN AND CHANNELIZER DEVICE SPACING AND TAPER LENGTH

SPEED	APPROACH STREET	TAPER LENGTH	SIGN SPACING	CHANNELIZER SPACING

SEE TABLE 'A'-'F' FOR SIGN AND CHANNELIZER DEVICE SPACING AND TAPER LENGTH

SPEED	APPROACH STREET	TAPER LENGTH	SIGN SPACING	CHANNELIZER SPACING

ABBREVIATIONS:

- S = Sign Spacing
- Min = Minimum
- LT = Left
- RT = Right
- LTP = Lane Traffic Panel
- TANSAT = Tow Away, No Stopping Anytime
- TANS = Tow Away, No Stopping

— CHART A —
 MINIMUM RECOMMENDED DELINEATOR/CONE & SIGN PLACEMENT

POSTED SPEED LIMIT	TAPER LENGTH FOR 12-FT LANE			CHANNELIZER SPACING		SIGN SPACING (ADVANCE OF TAPER & BETWEEN SIGNS)
	MERGING	SHIFTING	SHOULDER	TAPER	TANGENT	
20 MPH	80 FT.	40 FT.	27 FT.	20 FT.	40 FT.	100 FT.
25 MPH	125 FT.	63 FT.	42 FT.	25 FT.	63 FT.	100 FT.
30 MPH	180 FT.	90 FT.	60 FT.	30 FT.	90 FT.	350 FT.
35 MPH	245 FT.	123 FT.	82 FT.	35 FT.	123 FT.	350 FT.
40 MPH	320 FT.	160 FT.	107 FT.	40 FT.	160 FT.	350 FT.
* 45 MPH	540 FT.	270 FT.	180 FT.	45 FT.	270 FT.	500 FT.
* 50 MPH	600 FT.	300 FT.	200 FT.	50 FT.	300 FT.	500 FT.
* 55+MPH	660 FT.	330 FT.	220 FT.	55 FT.	330 FT.	PER TABLE 'A'

NOTES

1. A Flashing Arrow sign shall be used for each lane closed.
- *2. Two lane closure signs (C-20) shall be used on the approach to a lane closure with speeds of 45 mph or greater.

NOTE: This chart based on 12-foot wide lanes.

For lane widths greater than 12 feet, use the following formulae:

Taper formula:

$$L = S \times W \text{ for speeds of 45 mph or more.}$$

$$L = \frac{WS^2}{60} \text{ for speeds of 40 mph or less.}$$

Where:

L = Minimum length of taper.

S = Numerical value of posted speed limit prior to work or 85 percentile speed.

W = Width of offset.

i.e.: 50 mph and 19' lane; $L = 50 \times 19 = 950$ feet

REV. APR-2010 C:\JUTCM-DWG07.DWG

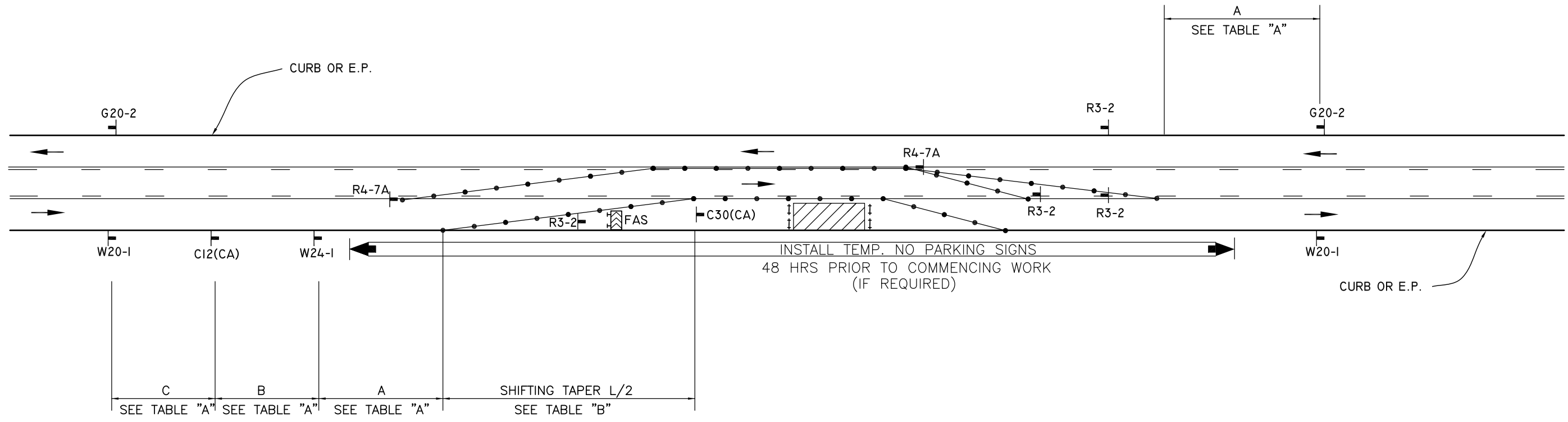

LEGEND

- TYPE III BARRICADE W/SIGN
- TYPE II BARRICADE W/O SIGN
- CHANNELIZING DEVICE
- TRAFFIC CONE WITH CLIP ON SIGN
- SIGN
- SIGNALIZED INTERSECTION
- ARROW PANEL (FLASHING ARROW) (WHERE REQUIRED)
- HIGH LEVEL WARNING DEVICE (FLAGTREE) (OPTIONAL)
- FLAGGER
- TANS TOW AWAY NO STOPPING ____ TO ____ (SHOW HOURS)
- TANSAT TOW AWAY NO STOPPING ANY TIME
- WORK ZONE (ACTIVITY AREA) LIMITS
- DIRECTION OF TRAFFIC (NOT PAVEMENT MARKING)
- ROADWAY DESIGNATION (A THROUGH D)

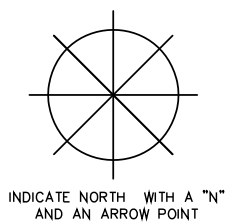
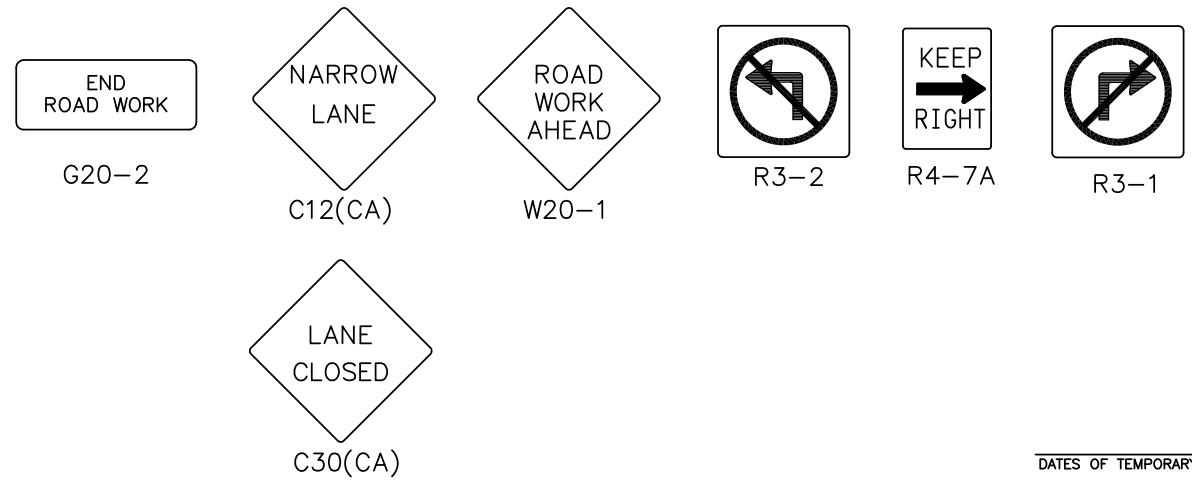

DATES OF TEMPORARY NO PARKING ZONE _____

WORKSITE TRAFFIC CONTROL PLAN
 SIDE OF ROAD WORK AREA
 SINGLE LANE CLOSURE - RIGHT LANE
 USING LEFT TURN LANE

DATE		SCALE	NONE
		DRAWING NO.	7



PLACEMENT OF BIKE LANE CLOSURE SIGN
(IF NECESSARY)

CONSTRUCTION NOTE:
ALL DRIVEWAYS TO REMAIN OPEN (WHENEVER POSSIBLE) THROUGHOUT TRAFFIC CONTROL ZONE

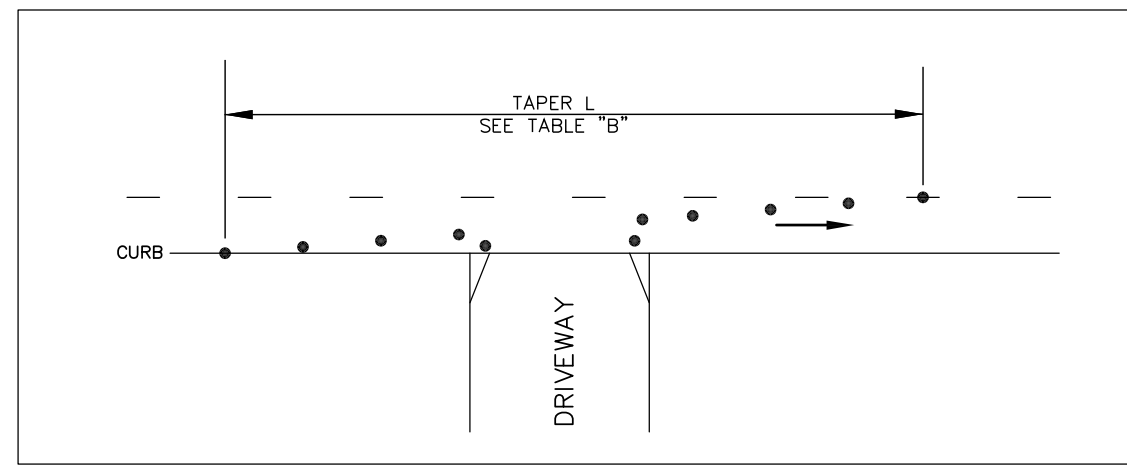

SEE TABLE 'A'-'F' FOR SIGN AND CHANNELIZER DEVICE SPACING AND TAPER LENGTH

SPEED	APPROACH STREET	TAPER LENGTH	SIGN SPACING	CHANNELIZER SPACING

SEE TABLE 'A'-'F' FOR SIGN AND CHANNELIZER DEVICE SPACING AND TAPER LENGTH

SPEED	APPROACH STREET	TAPER LENGTH	SIGN SPACING	CHANNELIZER SPACING

ABBREVIATIONS:

- S = Sign Spacing
- Min = Minimum
- LT = Left
- RT = Right
- LTP = Lane Traffic Panel
- TANSAT = Tow Away, No Stopping Anytime
- TANS = Tow Away, No Stopping

— CHART A —
MINIMUM RECOMMENDED DELINEATOR/CONE & SIGN PLACEMENT

POSTED SPEED LIMIT	TAPER LENGTH FOR 12-FT LANE			CHANNELIZER SPACING		SIGN SPACING (ADVANCE OF TAPER & BETWEEN SIGNS)
	MERGING	SHIFTING	SHOULDER	TAPER	TANGENT	
20 MPH	80 FT.	40 FT.	27 FT.	20 FT.	40 FT.	100 FT.
25 MPH	125 FT.	63 FT.	42 FT.	25 FT.	63 FT.	100 FT.
30 MPH	180 FT.	90 FT.	60 FT.	30 FT.	90 FT.	350 FT.
35 MPH	245 FT.	123 FT.	82 FT.	35 FT.	123 FT.	350 FT.
40 MPH	320 FT.	160 FT.	107 FT.	40 FT.	160 FT.	350 FT.
* 45 MPH	540 FT.	270 FT.	180 FT.	45 FT.	270 FT.	500 FT.
* 50 MPH	600 FT.	300 FT.	200 FT.	50 FT.	300 FT.	500 FT.
* 55+MPH	660 FT.	330 FT.	220 FT.	55 FT.	330 FT.	PER TABLE 'A'

NOTES

1. A Flashing Arrow sign shall be used for each lane closed.
- *2. Two lane closure signs (C-20) shall be used on the approach to a lane closure with speeds of 45 mph or greater.

NOTE: This chart based on 12-foot wide lanes.

For lane widths greater than 12 feet, use the following formulae:

Taper formula:

$$L = S \times W \text{ for speeds of 45 mph or more.}$$

$$L = \frac{WS^2}{60} \text{ for speeds of 40 mph or less.}$$

Where:

L = Minimum length of taper.

S = Numerical value of posted speed limit prior to work or 85 percentile speed.

W = Width of offset.

i.e.: 50 mph and 19' lane; $L = 50 \times 19 = 950$ feet

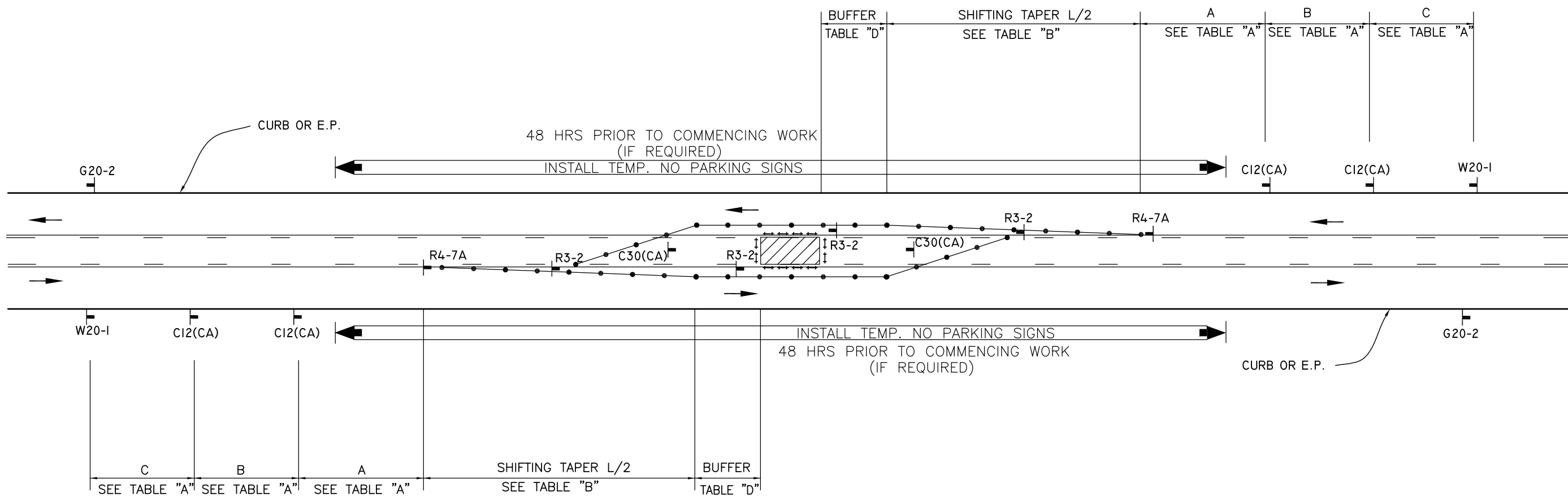

LEGEND

- TYPE III BARRICADE W/SIGN
- TYPE II BARRICADE W/O SIGN
- CHANNELIZING DEVICE
- TRAFFIC CONE WITH CLIP ON SIGN
- SIGN
- SIGNALIZED INTERSECTION
- ARROW PANEL (FLASHING ARROW) (WHERE REQUIRED)
- HIGH LEVEL WARNING DEVICE (FLAGTREE) (OPTIONAL)
- FLAGGER
- TANS TOW AWAY NO STOPPING ____ TO ____ (SHOW HOURS)
- TANSAT TOW AWAY NO STOPPING ANY TIME
- WORK ZONE (ACTIVITY AREA) LIMITS
- DIRECTION OF TRAFFIC (NOT PAVEMENT MARKING)
- ROADWAY DESIGNATION (A THROUGH D)

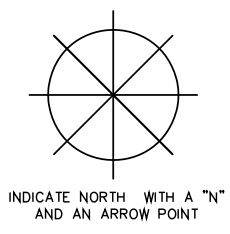
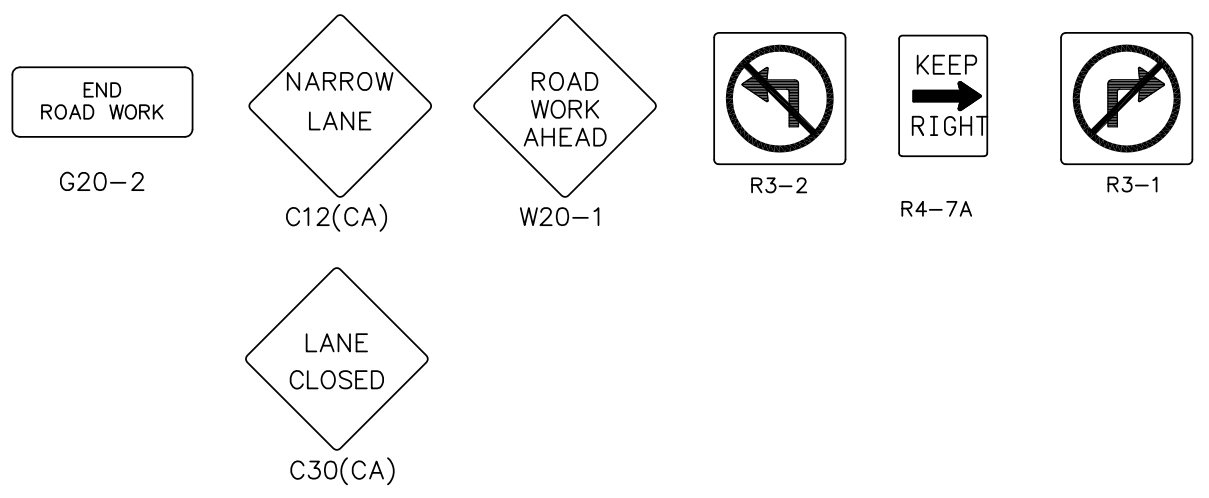

DATES OF TEMPORARY NO PARKING ZONE		
WORKSITE TRAFFIC CONTROL PLAN		
LEFT TURN LANE CLOSURE – MIDBLOCK		
DATE		SCALE
		NONE
		DRAWING NO.
		8

REV. APR-2010 C:\JUTCM-DWG08.DWG



CONSTRUCTION NOTE:
 ALL DRIVEWAYS TO REMAIN OPEN (WHENEVER POSSIBLE) THROUGHOUT TRAFFIC CONTROL ZONE



SEE TABLE 'A'-'F' FOR SIGN AND CHANNELIZER DEVICE SPACING AND TAPER LENGTH

SPEED	APPROACH STREET	TAPER LENGTH	SIGN SPACING	CHANNELIZER SPACING

SEE TABLE 'A'-'F' FOR SIGN AND CHANNELIZER DEVICE SPACING AND TAPER LENGTH

SPEED	APPROACH STREET	TAPER LENGTH	SIGN SPACING	CHANNELIZER SPACING

ABBREVIATIONS:

- S = Sign Spacing
- Min = Minimum
- LT = Left
- RT = Right
- LTP = Lane Traffic Panel
- TANSAT = Tow Away, No Stopping Anytime
- TANS = Tow Away, No Stopping

— CHART A —
 MINIMUM RECOMMENDED DELINEATOR/CONE & SIGN PLACEMENT

POSTED SPEED LIMIT	TAPER LENGTH FOR 12-FT LANE			CHANNELIZER SPACING		SIGN SPACING (ADVANCE OF TAPER & BETWEEN SIGNS)
	MERGING	SHIFTING	SHOULDER	TAPER	TANGENT	
20 MPH	80 FT.	40 FT.	27 FT.	20 FT.	40 FT.	100 FT.
25 MPH	125 FT.	63 FT.	42 FT.	25 FT.	63 FT.	100 FT.
30 MPH	180 FT.	90 FT.	60 FT.	30 FT.	90 FT.	350 FT.
35 MPH	245 FT.	123 FT.	82 FT.	35 FT.	123 FT.	350 FT.
40 MPH	320 FT.	160 FT.	107 FT.	40 FT.	160 FT.	350 FT.
* 45 MPH	540 FT.	270 FT.	180 FT.	45 FT.	270 FT.	500 FT.
* 50 MPH	600 FT.	300 FT.	200 FT.	50 FT.	300 FT.	500 FT.
* 55+MPH	660 FT.	330 FT.	220 FT.	55 FT.	330 FT.	PER TABLE 'A'

NOTES

1. A Flashing Arrow sign shall be used for each lane closed.
- *2. Two lane closure signs (C-20) shall be used on the approach to a lane closure with speeds of 45 mph or greater.

NOTE: This chart based on 12-foot wide lanes.

For lane widths greater than 12 feet, use the following formulae:

Taper formula:

$$L = S \times W \text{ for speeds of 45 mph or more.}$$

$$L = \frac{WS^2}{60} \text{ for speeds of 40 mph or less.}$$

Where:

L = Minimum length of taper.

S = Numerical value of posted speed limit prior to work or 85 percentile speed.

W = Width of offset.

i.e.: 50 mph and 19' lane; $L = 50 \times 19 = 950$ feet

STREET NAME

CURB OR E.P.

DOUBLE YELLOW OR CENTER TURN LANE

CURB OR E.P.

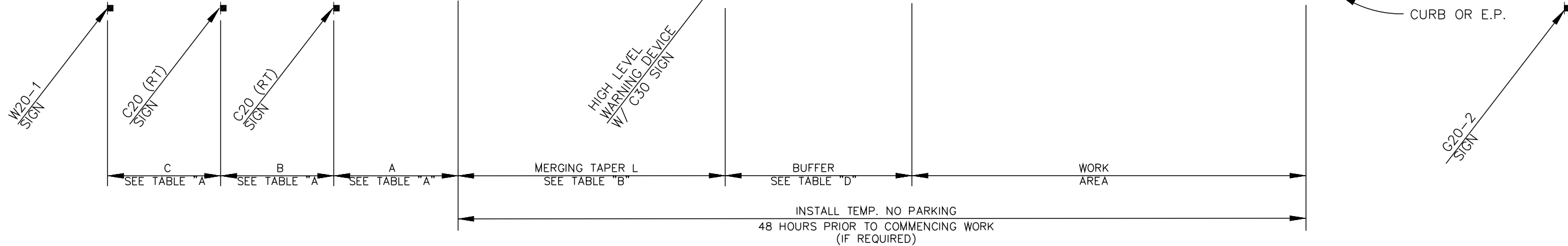

LEGEND

- TYPE III BARRICADE W/SIGN
- TYPE II BARRICADE W/O SIGN
- 28"(11cm) TRAFFIC CONES W/13"(5cm) REFLECTIVE SLEEVE FOR DAY/NIGHT USE OR DELINEATORS IF DAY USE ONLY
- TRAFFIC CONE WITH CLIP ON SIGN
- PROPOSED SIGN AND POST
- EXISTING SIGN AND POST
- SIGNALIZED INTERSECTION
- FLASHING ARROW SIGN
- HIGH LEVEL WARNING DEVICE WITH SIGN
- FLAGGER
- TANS** TOW AWAY NO STOPPING ____ TO ____ (SHOW HOURS)
- TANSAT** TOW AWAY NO STOPPING ANY TIME
- WORK ZONE LIMITS
- DIRECTION OF TRAFFIC
- ROADWAY DESIGNATION (A THROUGH D)

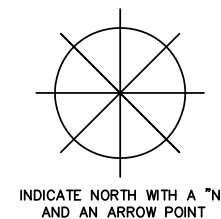
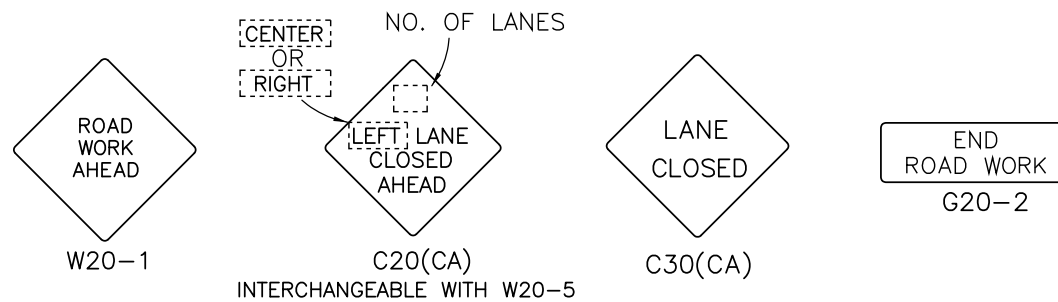

DATES OF TEMPORARY NO PARKING ZONE

WORKSITE TRAFFIC CONTROL PLAN
SINGLE LANE CLOSURE
(RIGHT LANE)

DATE		SCALE	NONE
		DRAWING NO.	9



PLACEMENT OF BIKE LANE CLOSURE SIGN
(IF NECESSARY)

CONSTRUCTION NOTE:
ALL DRIVEWAYS TO REMAIN OPEN (WHENEVER POSSIBLE) THROUGHOUT TRAFFIC CONTROL ZONE

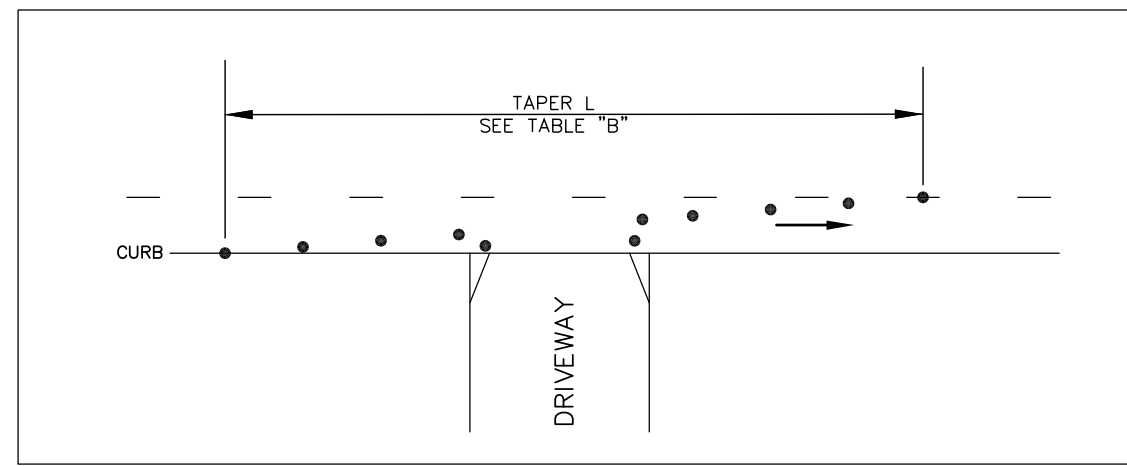

SEE TABLE 'A'-'F' FOR SIGN AND CHANNELIZER DEVICE SPACING AND TAPER LENGTH

SPEED	APPROACH STREET	TAPER LENGTH	SIGN SPACING	CHANNELIZER SPACING

SEE TABLE 'A'-'F' FOR SIGN AND CHANNELIZER DEVICE SPACING AND TAPER LENGTH

SPEED	APPROACH STREET	TAPER LENGTH	SIGN SPACING	CHANNELIZER SPACING

ABBREVIATIONS:

- S = Sign Spacing
- Min = Minimum
- LT = Left
- RT = Right
- LTP = Lane Traffic Panel
- TANSAT = Tow Away, No Stopping Anytime
- TANS = Tow Away, No Stopping

— CHART A —
MINIMUM RECOMMENDED DELINEATOR/CONE & SIGN PLACEMENT

POSTED SPEED LIMIT	TAPER LENGTH FOR 12-FT LANE			CHANNELIZER SPACING		SIGN SPACING (ADVANCE OF TAPER & BETWEEN SIGNS)
	MERGING	SHIFTING	SHOULDER	TAPER	TANGENT	
20 MPH	80 FT.	40 FT.	27 FT.	20 FT.	40 FT.	100 FT.
25 MPH	125 FT.	63 FT.	42 FT.	25 FT.	63 FT.	100 FT.
30 MPH	180 FT.	90 FT.	60 FT.	30 FT.	90 FT.	350 FT.
35 MPH	245 FT.	123 FT.	82 FT.	35 FT.	123 FT.	350 FT.
40 MPH	320 FT.	160 FT.	107 FT.	40 FT.	160 FT.	350 FT.
* 45 MPH	540 FT.	270 FT.	180 FT.	45 FT.	270 FT.	500 FT.
* 50 MPH	600 FT.	300 FT.	200 FT.	50 FT.	300 FT.	500 FT.
* 55+MPH	660 FT.	330 FT.	220 FT.	55 FT.	330 FT.	PER TABLE 'A'

NOTES

1. A Flashing Arrow sign shall be used for each lane closed.
- *2. Two lane closure signs (C-20) shall be used on the approach to a lane closure with speeds of 45 mph or greater.

NOTE: This chart based on 12-foot wide lanes.

For lane widths greater than 12 feet, use the following formulae:

Taper formula:

$$L = S \times W \text{ for speeds of 45 mph or more.}$$

$$L = \frac{WS^2}{60} \text{ for speeds of 40 mph or less.}$$

Where:

L = Minimum length of taper.

S = Numerical value of posted speed limit prior to work or 85 percentile speed.

W = Width of offset.

i.e.: 50 mph and 19' lane; $L = 50 \times 19 = 950$ feet

STREET NAME

CURB OR E.P.

CURB OR E.P.

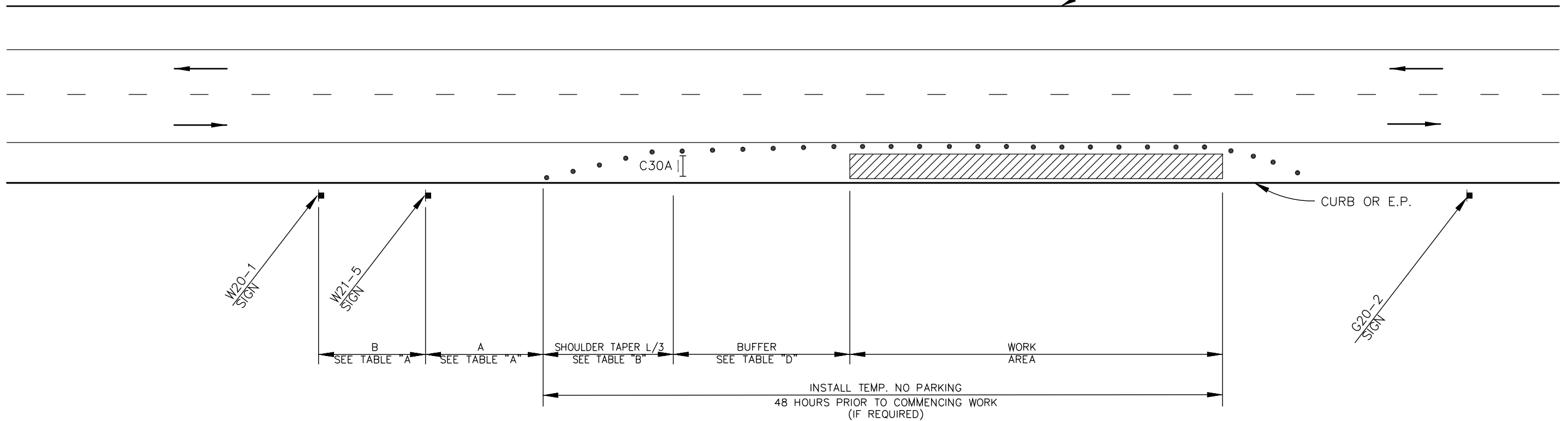

LEGEND

- TYPE III BARRICADE W/SIGN
- TYPE II BARRICADE W/O SIGN
- 28"(11cm)TRAFFIC CONES W/13"(5cm) REFLECTIVE SLEEVE FOR DAY/NIGHT USE OR DELINEATORS IF DAY USE ONLY
- TRAFFIC CONE WITH CLIP ON SIGN
- PROPOSED SIGN AND POST
- EXISTING SIGN AND POST
- SIGNALIZED INTERSECTION
- FLASHING ARROW SIGN
- HIGH LEVEL WARNING DEVICE WITH SIGN
- FLAGGER
- TANS** TOW AWAY NO STOPPING ____ TO ____ (SHOW HOURS)
- TANSAT** TOW AWAY NO STOPPING ANY TIME
- WORK ZONE LIMITS
- DIRECTION OF TRAFFIC
- ROADWAY DESIGNATION (A THROUGH D)

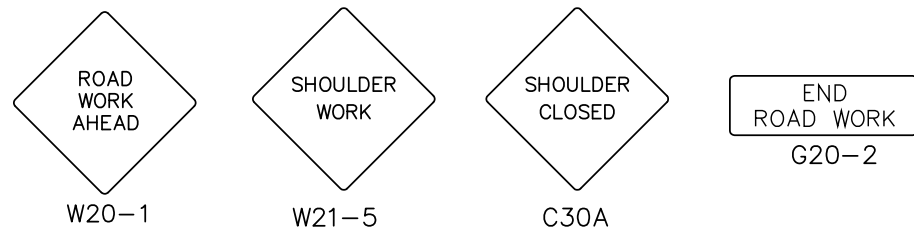

DATES OF TEMPORARY NO PARKING ZONE _____

WORKSITE TRAFFIC CONTROL PLAN		
SHOULDER CLOSURE		
DATE		SCALE
		NONE
		DRAWING NO.
		10

REV. APR-2010 C:\JTCM-DWG\10.DWG



CONSTRUCTION NOTE:
ALL DRIVEWAYS TO REMAIN OPEN (WHENEVER POSSIBLE) THROUGHOUT TRAFFIC CONTROL ZONE



SEE TABLE 'A'-'F' FOR SIGN AND CHANNELIZER DEVICE SPACING AND TAPER LENGTH

SPEED	APPROACH STREET	TAPER LENGTH	SIGN SPACING	CHANNELIZER SPACING

SEE TABLE 'A'-'F' FOR SIGN AND CHANNELIZER DEVICE SPACING AND TAPER LENGTH

SPEED	APPROACH STREET	TAPER LENGTH	SIGN SPACING	CHANNELIZER SPACING

ABBREVIATIONS:

- S = Sign Spacing
- Min = Minimum
- LT = Left
- RT = Right
- LTP = Lane Traffic Panel
- TANSAT = Tow Away, No Stopping Anytime
- TANS = Tow Away, No Stopping

— CHART A —
MINIMUM RECOMMENDED DELINEATOR/CONE & SIGN PLACEMENT

POSTED SPEED LIMIT	TAPER LENGTH FOR 12-FT LANE			CHANNELIZER SPACING		SIGN SPACING (ADVANCE OF TAPER & BETWEEN SIGNS)
	MERGING	SHIFTING	SHOULDER	TAPER	TANGENT	
20 MPH	80 FT.	40 FT.	27 FT.	20 FT.	40 FT.	100 FT.
25 MPH	125 FT.	63 FT.	42 FT.	25 FT.	63 FT.	100 FT.
30 MPH	180 FT.	90 FT.	60 FT.	30 FT.	90 FT.	350 FT.
35 MPH	245 FT.	123 FT.	82 FT.	35 FT.	123 FT.	350 FT.
40 MPH	320 FT.	160 FT.	107 FT.	40 FT.	160 FT.	350 FT.
* 45 MPH	540 FT.	270 FT.	180 FT.	45 FT.	270 FT.	500 FT.
* 50 MPH	600 FT.	300 FT.	200 FT.	50 FT.	300 FT.	500 FT.
* 55+MPH	660 FT.	330 FT.	220 FT.	55 FT.	330 FT.	PER TABLE 'A'

NOTES

1. A Flashing Arrow sign shall be used for each lane closed.
- *2. Two lane closure signs (C-20) shall be used on the approach to a lane closure with speeds of 45 mph or greater.

NOTE: This chart based on 12-foot wide lanes.

For lane widths greater than 12 feet, use the following formulae:

Taper formula:

$$L = S \times W \text{ for speeds of 45 mph or more.}$$

$$L = \frac{WS^2}{60} \text{ for speeds of 40 mph or less.}$$

Where:

L = Minimum length of taper.

S = Numerical value of posted speed limit prior to work or 85 percentile speed.

W = Width of offset.

i.e.: 50 mph and 19' lane; $L = 50 \times 19 = 950$ feet

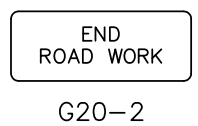
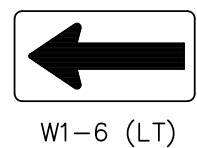
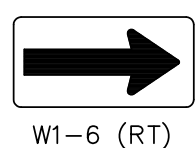
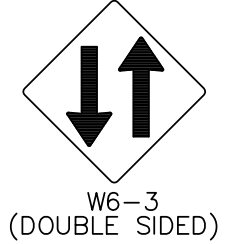
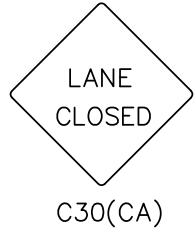
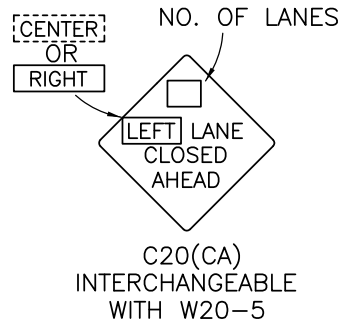
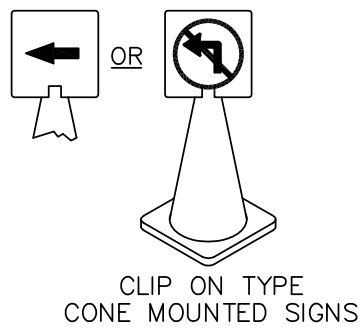
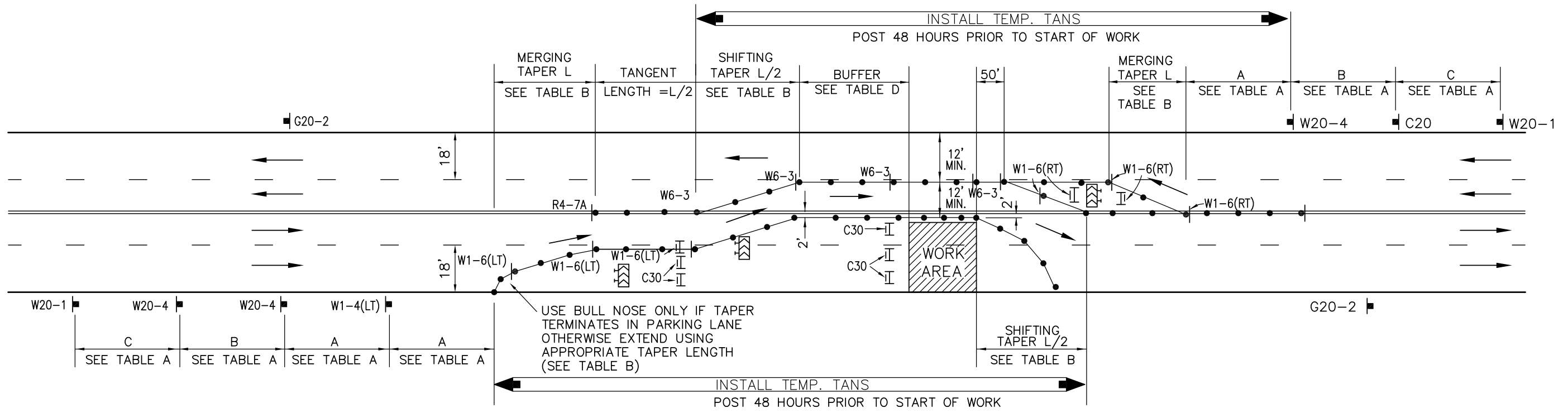

LEGEND

- TYPE III BARRICADE W/SIGN
- TYPE II BARRICADE W/O SIGN
- CHANNELIZING DEVICE
- TRAFFIC CONE WITH CLIP ON SIGN
- SIGN
- SIGNALIZED INTERSECTION
- ARROW PANEL (FLASHING ARROW) (WHERE REQUIRED)
- HIGH LEVEL WARNING DEVICE (FLAGTREE) (OPTIONAL)
- FLAGGER
- TANS** TOW AWAY NO STOPPING ____ TO ____ (SHOW HOURS)
- TANSAT** TOW AWAY NO STOPPING ANY TIME
- WORK ZONE (ACTIVITY AREA) LIMITS
- DIRECTION OF TRAFFIC (NOT PAVEMENT MARKING)
- ROADWAY DESIGNATION (A THROUGH D)

DATES OF TEMPORARY NO PARKING ZONE

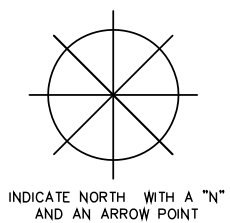

WORKSITE TRAFFIC CONTROL PLAN		
MIDBLOCK CLOSURE FOR ONE DIRECTION OF TRAFFIC		
DATE		SCALE
		NONE
		DRAWING NO. 11

REV. APR-2010 C:\JTCM-DWG11.DWG



CONSTRUCTION NOTE:
ALL DRIVEWAYS TO REMAIN OPEN (WHENEVER POSSIBLE) THROUGHOUT TRAFFIC CONTROL ZONE



SEE TABLE 'A'-'F' FOR SIGN AND CHANNELIZER DEVICE SPACING AND TAPER LENGTH

SPEED	APPROACH STREET	TAPER LENGTH	SIGN SPACING	CHANNELIZER SPACING

SEE TABLE 'A'-'F' FOR SIGN AND CHANNELIZER DEVICE SPACING AND TAPER LENGTH

SPEED	APPROACH STREET	TAPER LENGTH	SIGN SPACING	CHANNELIZER SPACING

ABBREVIATIONS:

- S = Sign Spacing
- Min = Minimum
- LT = Left
- RT = Right
- LTP = Lane Traffic Panel
- TANSAT = Tow Away, No Stopping Anytime
- TANS = Tow Away, No Stopping

— CHART A —
MINIMUM RECOMMENDED DELINEATOR/CONE & SIGN PLACEMENT

POSTED SPEED LIMIT	TAPER LENGTH FOR 12-FT LANE			CHANNELIZER SPACING		SIGN SPACING (ADVANCE OF TAPER & BETWEEN SIGNS)
	MERGING	SHIFTING	SHOULDER	TAPER	TANGENT	
20 MPH	80 FT.	40 FT.	27 FT.	20 FT.	40 FT.	100 FT.
25 MPH	125 FT.	63 FT.	42 FT.	25 FT.	63 FT.	100 FT.
30 MPH	180 FT.	90 FT.	60 FT.	30 FT.	90 FT.	350 FT.
35 MPH	245 FT.	123 FT.	82 FT.	35 FT.	123 FT.	350 FT.
40 MPH	320 FT.	160 FT.	107 FT.	40 FT.	160 FT.	350 FT.
* 45 MPH	540 FT.	270 FT.	180 FT.	45 FT.	270 FT.	500 FT.
* 50 MPH	600 FT.	300 FT.	200 FT.	50 FT.	300 FT.	500 FT.
* 55+MPH	660 FT.	330 FT.	220 FT.	55 FT.	330 FT.	PER TABLE 'A'

NOTES

1. A Flashing Arrow sign shall be used for each lane closed.
- *2. Two lane closure signs (C-20) shall be used on the approach to a lane closure with speeds of 45 mph or greater.

NOTE: This chart based on 12-foot wide lanes.

For lane widths greater than 12 feet, use the following formulae:

Taper formula:

$$L = S \times W \text{ for speeds of 45 mph or more.}$$

$$L = \frac{WS^2}{60} \text{ for speeds of 40 mph or less.}$$

Where:

L = Minimum length of taper.

S = Numerical value of posted speed limit prior to work or 85 percentile speed.

W = Width of offset.

i.e.: 50 mph and 19' lane; $L = 50 \times 19 = 950$ feet

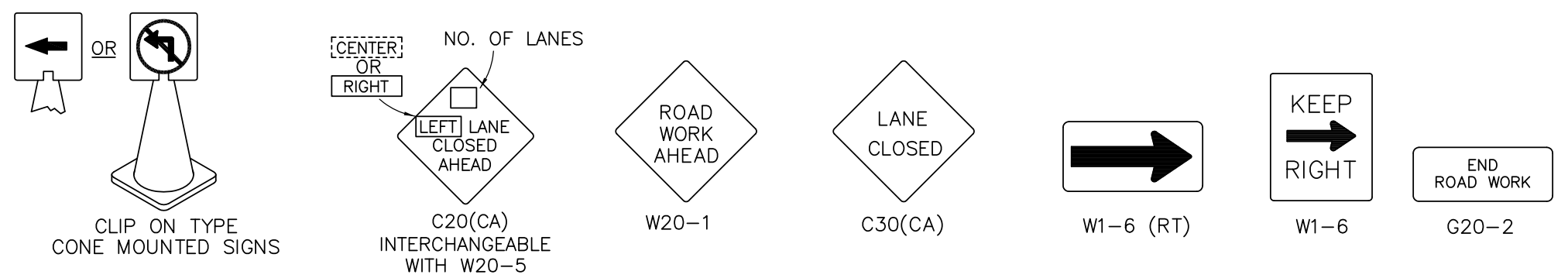
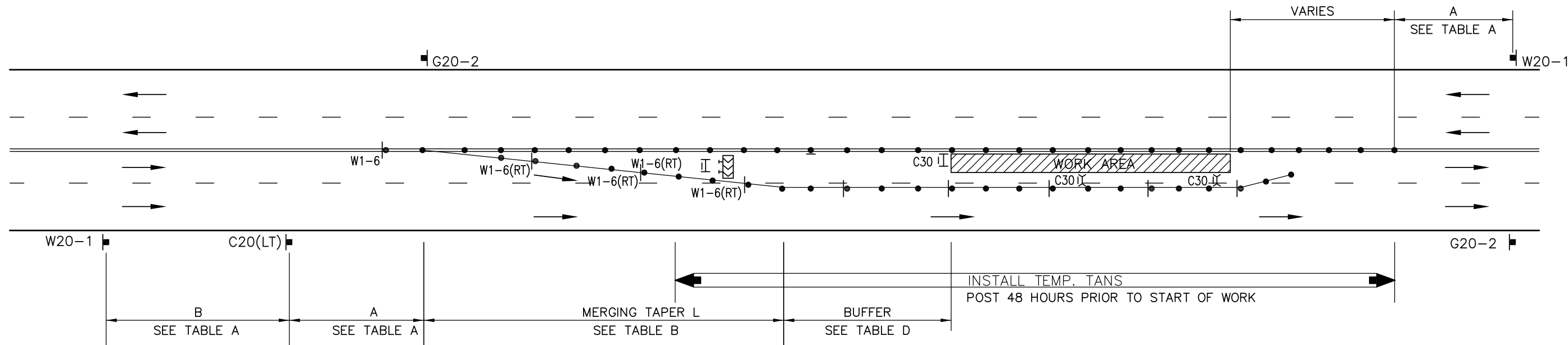

LEGEND

- TYPE III BARRICADE W/SIGN
- TYPE II BARRICADE W/O SIGN
- CHANNELIZING DEVICE
- TRAFFIC CONE WITH CLIP ON SIGN
- SIGN
- SIGNALIZED INTERSECTION
- ARROW PANEL (FLASHING ARROW) (WHERE REQUIRED)
- HIGH LEVEL WARNING DEVICE (FLAGTREE) (OPTIONAL)
- FLAGGER
- TANS TOW AWAY NO STOPPING ____ TO ____ (SHOW HOURS)
- TANSAT TOW AWAY NO STOPPING ANY TIME
- WORK ZONE (ACTIVITY AREA) LIMITS
- DIRECTION OF TRAFFIC (NOT PAVEMENT MARKING)
- ROADWAY DESIGNATION (A THROUGH D)

DATES OF TEMPORARY NO PARKING ZONE _____

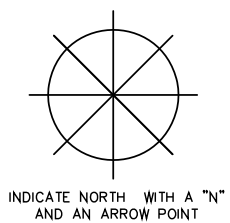

WORKSITE TRAFFIC CONTROL PLAN MIDBLOCK NO. 1 LANE CLOSURE		
DATE		SCALE
		NONE
		DRAWING NO. 12

REV. APR-2010 C:\JTCM-DWG12.DWG



CONSTRUCTION NOTE:
ALL DRIVEWAYS TO REMAIN OPEN (WHENEVER POSSIBLE) THROUGHOUT TRAFFIC CONTROL ZONE



SEE TABLE 'A'-'F' FOR SIGN AND CHANNELIZER DEVICE SPACING AND TAPER LENGTH

SPEED	APPROACH STREET	TAPER LENGTH	SIGN SPACING	CHANNELIZER SPACING

SEE TABLE 'A'-'F' FOR SIGN AND CHANNELIZER DEVICE SPACING AND TAPER LENGTH

SPEED	APPROACH STREET	TAPER LENGTH	SIGN SPACING	CHANNELIZER SPACING

ABBREVIATIONS:

- S = Sign Spacing
- Min = Minimum
- LT = Left
- RT = Right
- LTP = Lane Traffic Panel
- TANSAT = Tow Away, No Stopping Anytime
- TANS = Tow Away, No Stopping

— CHART A —
MINIMUM RECOMMENDED DELINEATOR/CONE & SIGN PLACEMENT

POSTED SPEED LIMIT	TAPER LENGTH FOR 12-FT LANE			CHANNELIZER SPACING		SIGN SPACING (ADVANCE OF TAPER & BETWEEN SIGNS)
	MERGING	SHIFTING	SHOULDER	TAPER	TANGENT	
20 MPH	80 FT.	40 FT.	27 FT.	20 FT.	40 FT.	100 FT.
25 MPH	125 FT.	63 FT.	42 FT.	25 FT.	63 FT.	100 FT.
30 MPH	180 FT.	90 FT.	60 FT.	30 FT.	90 FT.	350 FT.
35 MPH	245 FT.	123 FT.	82 FT.	35 FT.	123 FT.	350 FT.
40 MPH	320 FT.	160 FT.	107 FT.	40 FT.	160 FT.	350 FT.
* 45 MPH	540 FT.	270 FT.	180 FT.	45 FT.	270 FT.	500 FT.
* 50 MPH	600 FT.	300 FT.	200 FT.	50 FT.	300 FT.	500 FT.
* 55+MPH	660 FT.	330 FT.	220 FT.	55 FT.	330 FT.	PER TABLE 'A'

NOTES

1. A Flashing Arrow sign shall be used for each lane closed.
- *2. Two lane closure signs (C-20) shall be used on the approach to a lane closure with speeds of 45 mph or greater.

NOTE: This chart based on 12-foot wide lanes.

For lane widths greater than 12 feet, use the following formulae:

Taper formula:

$$L = S \times W \text{ for speeds of 45 mph or more.}$$

$$L = \frac{WS^2}{60} \text{ for speeds of 40 mph or less.}$$

Where:

L = Minimum length of taper.

S = Numerical value of posted speed limit prior to work or 85 percentile speed.

W = Width of offset.

i.e.: 50 mph and 19' lane; $L = 50 \times 19 = 950$ feet

REV. APR-2010 C:\JITCM-DWG13.DWG

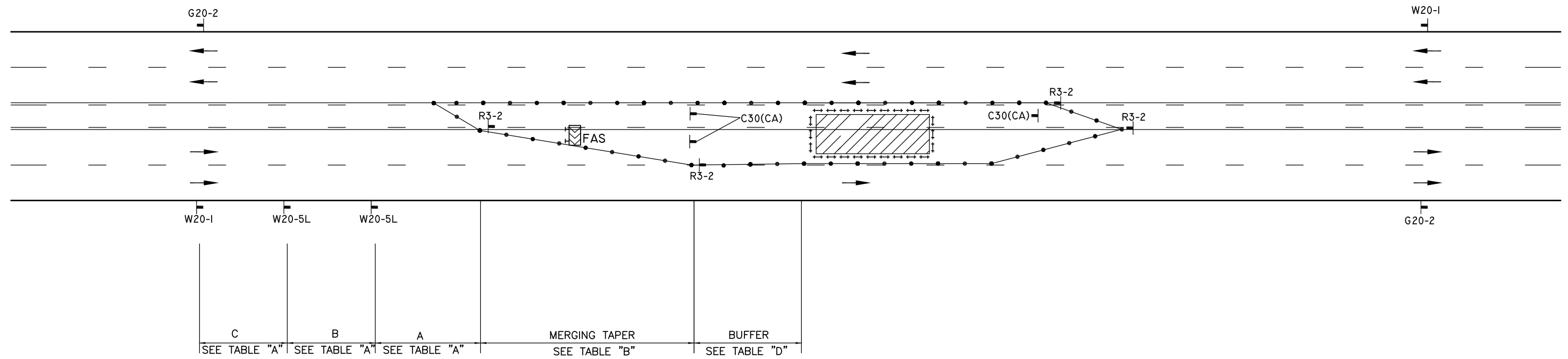

LEGEND

- TYPE III BARRICADE W/SIGN
- TYPE II BARRICADE W/O SIGN
- CHANNELIZING DEVICE
- TRAFFIC CONE WITH CLIP ON SIGN
- SIGN
- SIGNALIZED INTERSECTION
- ARROW PANEL (FLASHING ARROW) (WHERE REQUIRED)
- HIGH LEVEL WARNING DEVICE (FLAGTREE) (OPTIONAL)
- FLAGGER
- TANS TOW AWAY NO STOPPING ____ TO ____ (SHOW HOURS)
- TANSAT TOW AWAY NO STOPPING ANY TIME
- WORK ZONE (ACTIVITY AREA) LIMITS
- DIRECTION OF TRAFFIC (NOT PAVEMENT MARKING)
- ROADWAY DESIGNATION (A THROUGH D)

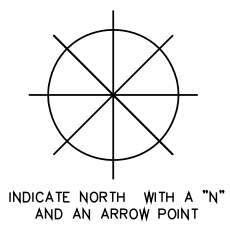
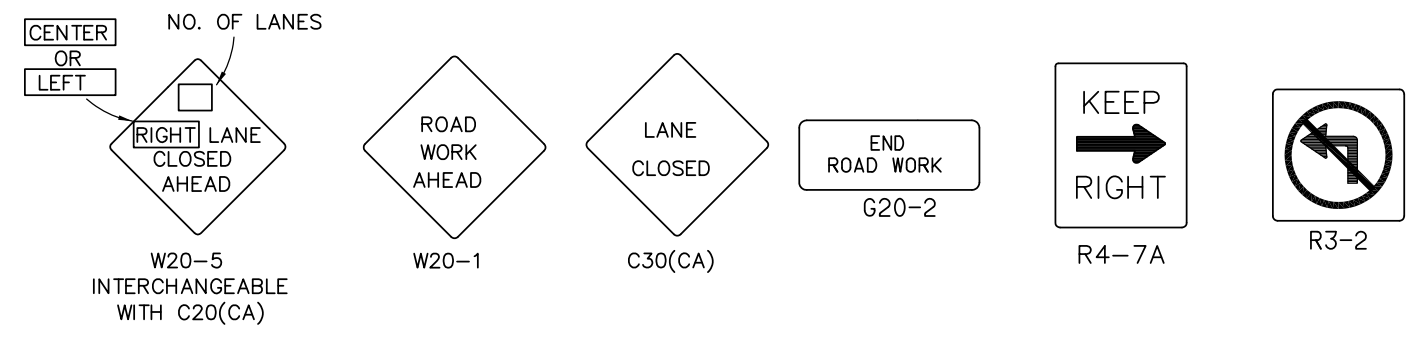

DATES OF TEMPORARY NO PARKING ZONE		
WORKSITE TRAFFIC CONTROL PLAN MIDBLOCK NO. 1 LANE AND LEFT TURN LANE CLOSURE		
DATE		SCALE
		NONE
		DRAWING NO.
		13



PLACEMENT OF BIKE LANE CLOSURE SIGN
(IF NECESSARY)

CONSTRUCTION NOTE:
ALL DRIVEWAYS TO REMAIN OPEN (WHENEVER POSSIBLE) THROUGHOUT TRAFFIC CONTROL ZONE

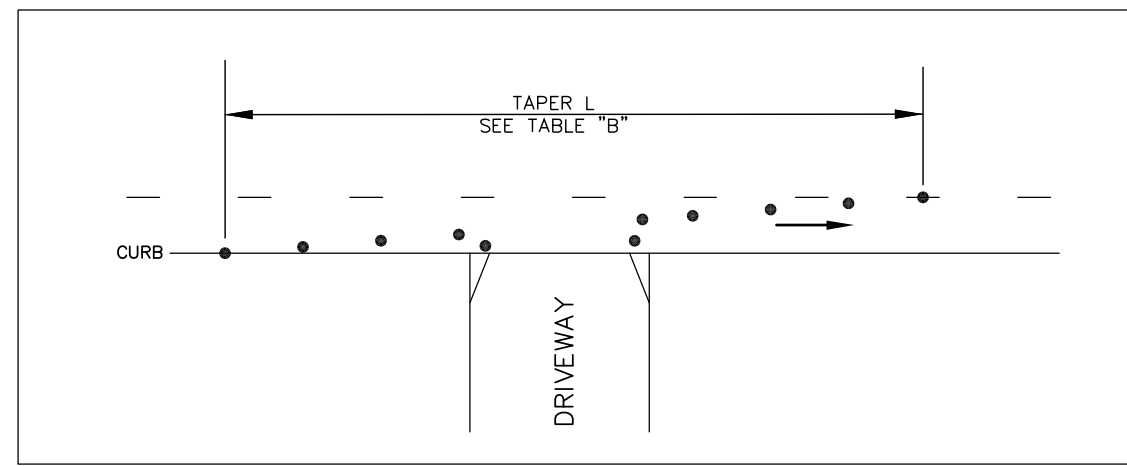

SEE TABLE 'A'-'F' FOR SIGN AND CHANNELIZER DEVICE SPACING AND TAPER LENGTH

SPEED	APPROACH STREET	TAPER LENGTH	SIGN SPACING	CHANNELIZER SPACING

SEE TABLE 'A'-'F' FOR SIGN AND CHANNELIZER DEVICE SPACING AND TAPER LENGTH

SPEED	APPROACH STREET	TAPER LENGTH	SIGN SPACING	CHANNELIZER SPACING

ABBREVIATIONS:

- S = Sign Spacing
- Min = Minimum
- LT = Left
- RT = Right
- LTP = Lane Traffic Panel
- TANSAT = Tow Away, No Stopping Anytime
- TANS = Tow Away, No Stopping

— CHART A —
MINIMUM RECOMMENDED DELINEATOR/CONE & SIGN PLACEMENT

POSTED SPEED LIMIT	TAPER LENGTH FOR 12-FT LANE			CHANNELIZER SPACING		SIGN SPACING (ADVANCE OF TAPER & BETWEEN SIGNS)
	MERGING	SHIFTING	SHOULDER	TAPER	TANGENT	
20 MPH	80 FT.	40 FT.	27 FT.	20 FT.	40 FT.	100 FT.
25 MPH	125 FT.	63 FT.	42 FT.	25 FT.	63 FT.	100 FT.
30 MPH	180 FT.	90 FT.	60 FT.	30 FT.	90 FT.	350 FT.
35 MPH	245 FT.	123 FT.	82 FT.	35 FT.	123 FT.	350 FT.
40 MPH	320 FT.	160 FT.	107 FT.	40 FT.	160 FT.	350 FT.
* 45 MPH	540 FT.	270 FT.	180 FT.	45 FT.	270 FT.	500 FT.
* 50 MPH	600 FT.	300 FT.	200 FT.	50 FT.	300 FT.	500 FT.
* 55+MPH	660 FT.	330 FT.	220 FT.	55 FT.	330 FT.	PER TABLE 'A'

NOTES

1. A Flashing Arrow sign shall be used for each lane closed.
- *2. Two lane closure signs (C-20) shall be used on the approach to a lane closure with speeds of 45 mph or greater.

NOTE: This chart based on 12-foot wide lanes.

For lane widths greater than 12 feet, use the following formulae:

Taper formula:

$$L = S \times W \text{ for speeds of 45 mph or more.}$$

$$L = \frac{WS^2}{60} \text{ for speeds of 40 mph or less.}$$

Where:

- L = Minimum length of taper.
- S = Numerical value of posted speed limit prior to work or 85 percentile speed.
- W = Width of offset.

i.e.: 50 mph and 19' lane; $L = 50 \times 19 = 950$ feet

REV. APR-2010 C:\JITCM-DWG14.DWG

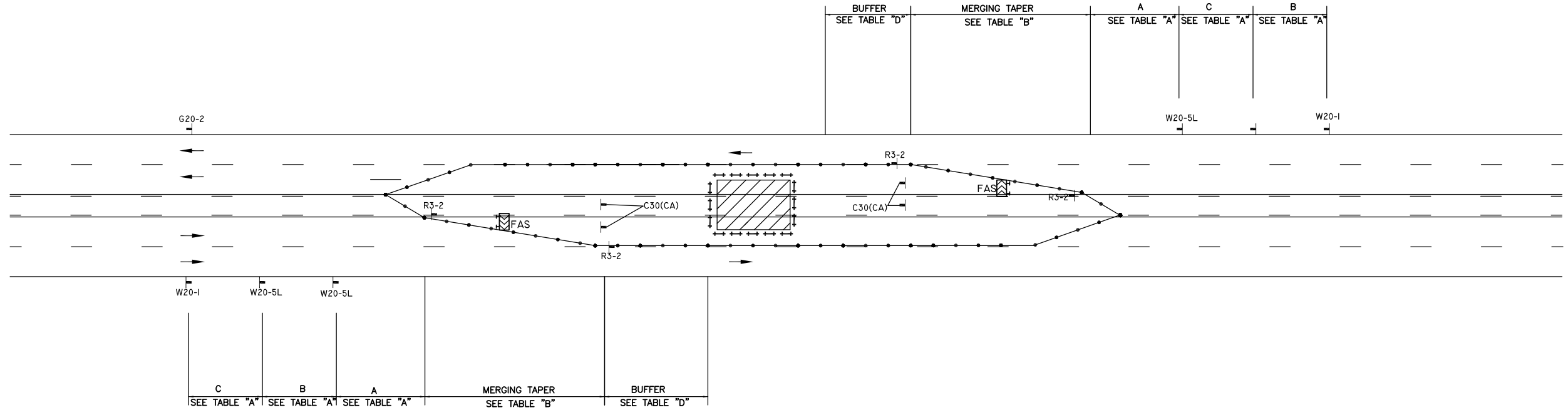

LEGEND

- TYPE III BARRICADE W/SIGN
- TYPE II BARRICADE W/O SIGN
- CHANNELIZING DEVICE
- TRAFFIC CONE WITH CLIP ON SIGN
- SIGN
- SIGNALIZED INTERSECTION
- ARROW PANEL (FLASHING ARROW) (WHERE REQUIRED)
- HIGH LEVEL WARNING DEVICE (FLAGTREE) (OPTIONAL)
- FLAGGER
- TANS TOW AWAY NO STOPPING ____ TO ____ (SHOW HOURS)
- TANSAT TOW AWAY NO STOPPING ANY TIME
- WORK ZONE (ACTIVITY AREA) LIMITS
- DIRECTION OF TRAFFIC (NOT PAVEMENT MARKING)
- ROADWAY DESIGNATION (A THROUGH D)

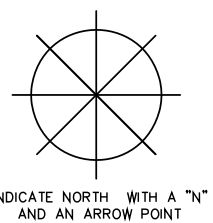
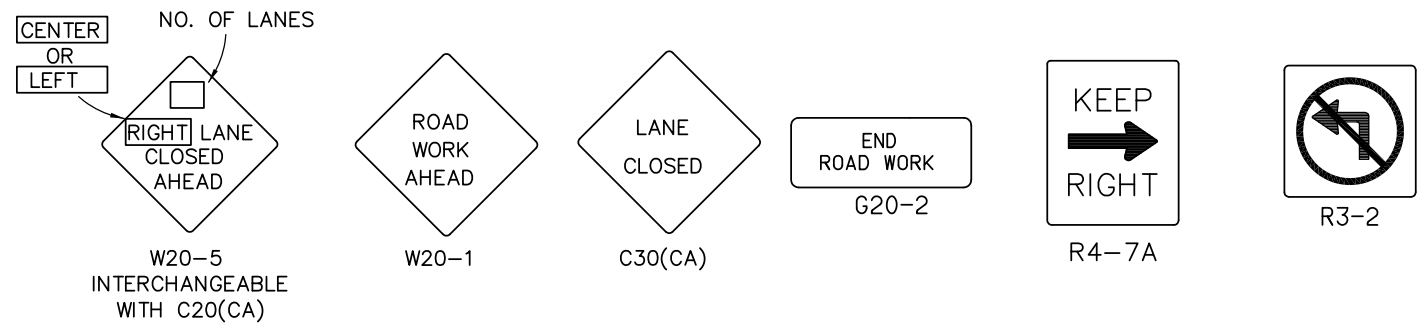

DATES OF TEMPORARY NO PARKING ZONE		
WORKSITE TRAFFIC CONTROL PLAN MIDBLOCK NO.1 LANES AND LEFT TURN LANE CLOSURE		
DATE		SCALE
		NONE
		DRAWING NO.
		14



PLACEMENT OF BIKE LANE CLOSURE SIGN
(IF NECESSARY)

CONSTRUCTION NOTE:
ALL DRIVEWAYS TO REMAIN OPEN (WHENEVER POSSIBLE) THROUGHOUT TRAFFIC CONTROL ZONE

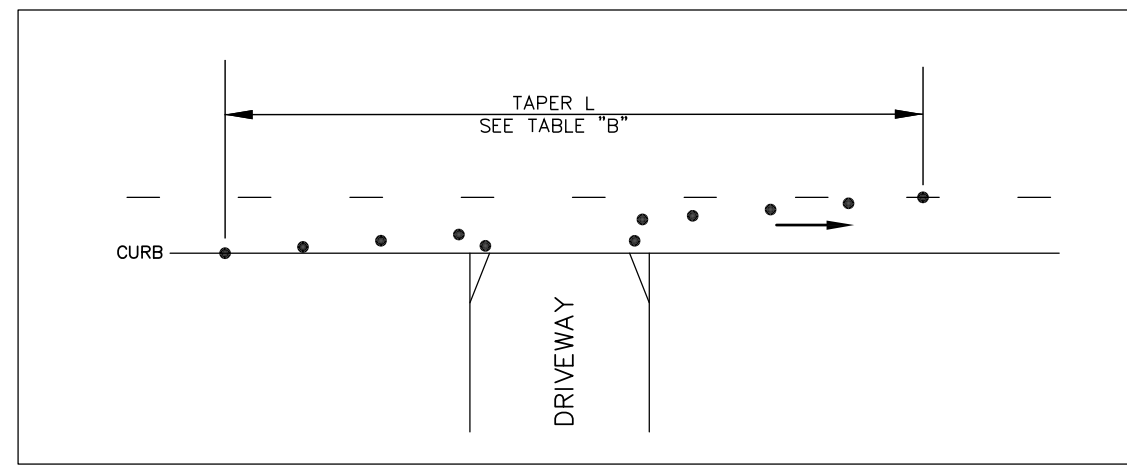

SEE TABLE 'A'-'F' FOR SIGN AND CHANNELIZER DEVICE SPACING AND TAPER LENGTH

SPEED	APPROACH STREET	TAPER LENGTH	SIGN SPACING	CHANNELIZER SPACING

SEE TABLE 'A'-'F' FOR SIGN AND CHANNELIZER DEVICE SPACING AND TAPER LENGTH

SPEED	APPROACH STREET	TAPER LENGTH	SIGN SPACING	CHANNELIZER SPACING

ABBREVIATIONS:

- S = Sign Spacing
- Min = Minimum
- LT = Left
- RT = Right
- LTP = Lane Traffic Panel
- TANSAT = Tow Away, No Stopping Anytime
- TANS = Tow Away, No Stopping

— CHART A —
MINIMUM RECOMMENDED DELINEATOR/CONE & SIGN PLACEMENT

POSTED SPEED LIMIT	TAPER LENGTH FOR 12-FT LANE			CHANNELIZER SPACING		SIGN SPACING (ADVANCE OF TAPER & BETWEEN SIGNS)
	MERGING	SHIFTING	SHOULDER	TAPER	TANGENT	
20 MPH	80 FT.	40 FT.	27 FT.	20 FT.	40 FT.	100 FT.
25 MPH	125 FT.	63 FT.	42 FT.	25 FT.	63 FT.	100 FT.
30 MPH	180 FT.	90 FT.	60 FT.	30 FT.	90 FT.	350 FT.
35 MPH	245 FT.	123 FT.	82 FT.	35 FT.	123 FT.	350 FT.
40 MPH	320 FT.	160 FT.	107 FT.	40 FT.	160 FT.	350 FT.
* 45 MPH	540 FT.	270 FT.	180 FT.	45 FT.	270 FT.	500 FT.
* 50 MPH	600 FT.	300 FT.	200 FT.	50 FT.	300 FT.	500 FT.
* 55+MPH	660 FT.	330 FT.	220 FT.	55 FT.	330 FT.	PER TABLE 'A'

NOTES

1. A Flashing Arrow sign shall be used for each lane closed.
- *2. Two lane closure signs (C-20) shall be used on the approach to a lane closure with speeds of 45 mph or greater.

NOTE: This chart based on 12-foot wide lanes.

For lane widths greater than 12 feet, use the following formulae:

Taper formula:

$$L = S \times W \text{ for speeds of 45 mph or more.}$$

$$L = \frac{WS^2}{60} \text{ for speeds of 40 mph or less.}$$

Where:

L = Minimum length of taper.

S = Numerical value of posted speed limit prior to work or 85 percentile speed.

W = Width of offset.

i.e.: 50 mph and 19' lane; $L = 50 \times 19 = 950$ feet

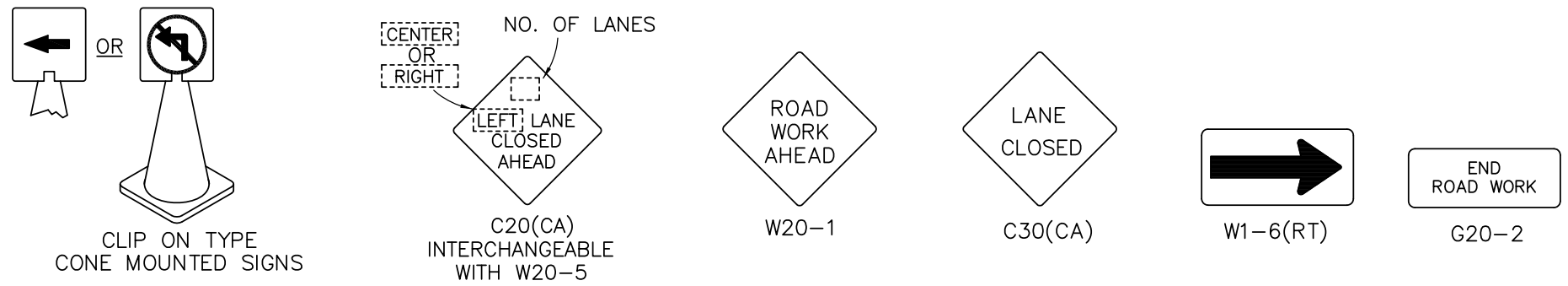
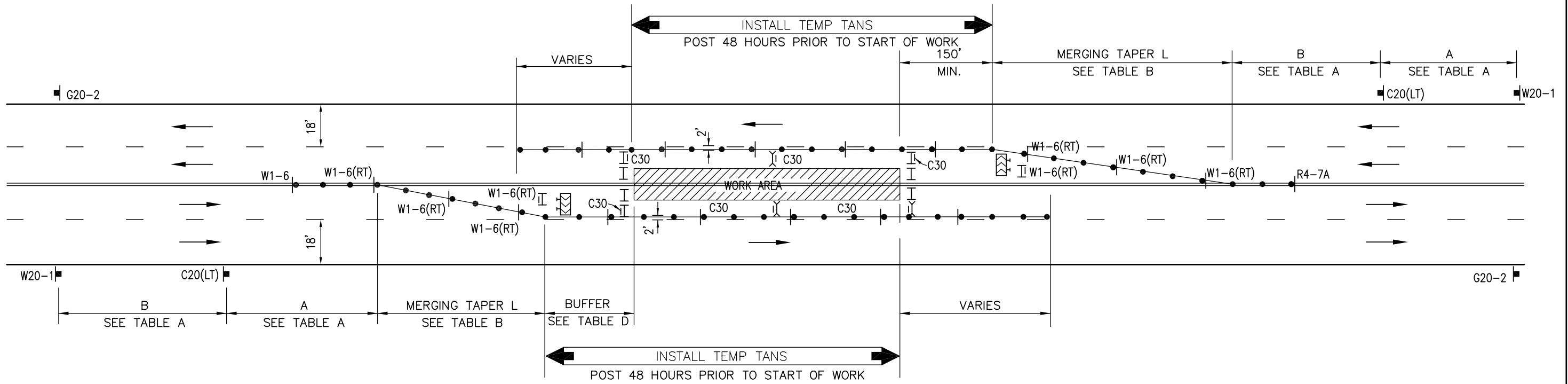

LEGEND

- TYPE III BARRICADE W/SIGN
- TYPE II BARRICADE W/O SIGN
- CHANNELIZING DEVICE
- TRAFFIC CONE WITH CLIP ON SIGN
- SIGN
- SIGNALIZED INTERSECTION
- ARROW PANEL (FLASHING ARROW) (WHERE REQUIRED)
- HIGH LEVEL WARNING DEVICE (FLAGTREE) (OPTIONAL)
- FLAGGER
- TANS** TOW AWAY NO STOPPING ____ TO ____ (SHOW HOURS)
- TANSAT** TOW AWAY NO STOPPING ANY TIME
- WORK ZONE (ACTIVITY AREA) LIMITS
- DIRECTION OF TRAFFIC (NOT PAVEMENT MARKING)
- ROADWAY DESIGNATION (A THROUGH D)

DATES OF TEMPORARY NO PARKING ZONE _____

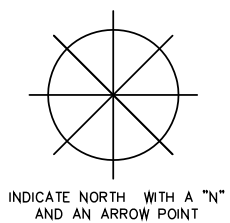

WORKSITE TRAFFIC CONTROL PLAN MIDBLOCK NO. 1 LANE CLOSURES FOR BOTH LANES OF TRAFFIC		
DATE		SCALE
		NONE
		DRAWING NO. 15

REV. APR-2010 C:\JTCM-DWG15.DWG



CONSTRUCTION NOTE:
 ALL DRIVEWAYS TO REMAIN OPEN (WHENEVER POSSIBLE) THROUGHOUT TRAFFIC CONTROL ZONE



SEE TABLE 'A'-'F' FOR SIGN AND CHANNELIZER DEVICE SPACING AND TAPER LENGTH

SPEED	APPROACH STREET	TAPER LENGTH	SIGN SPACING	CHANNELIZER SPACING

SEE TABLE 'A'-'F' FOR SIGN AND CHANNELIZER DEVICE SPACING AND TAPER LENGTH

SPEED	APPROACH STREET	TAPER LENGTH	SIGN SPACING	CHANNELIZER SPACING

ABBREVIATIONS:

- S = Sign Spacing
- Min = Minimum
- LT = Left
- RT = Right
- LTP = Lane Traffic Panel
- TANSAT = Tow Away, No Stopping Anytime
- TANS = Tow Away, No Stopping

— CHART A —
 MINIMUM RECOMMENDED DELINEATOR/CONE & SIGN PLACEMENT

POSTED SPEED LIMIT	TAPER LENGTH FOR 12-FT LANE			CHANNELIZER SPACING		SIGN SPACING (ADVANCE OF TAPER & BETWEEN SIGNS)
	MERGING	SHIFTING	SHOULDER	TAPER	TANGENT	
20 MPH	80 FT.	40 FT.	27 FT.	20 FT.	40 FT.	100 FT.
25 MPH	125 FT.	63 FT.	42 FT.	25 FT.	63 FT.	100 FT.
30 MPH	180 FT.	90 FT.	60 FT.	30 FT.	90 FT.	350 FT.
35 MPH	245 FT.	123 FT.	82 FT.	35 FT.	123 FT.	350 FT.
40 MPH	320 FT.	160 FT.	107 FT.	40 FT.	160 FT.	350 FT.
* 45 MPH	540 FT.	270 FT.	180 FT.	45 FT.	270 FT.	500 FT.
* 50 MPH	600 FT.	300 FT.	200 FT.	50 FT.	300 FT.	500 FT.
* 55+MPH	660 FT.	330 FT.	220 FT.	55 FT.	330 FT.	PER TABLE 'A'

NOTES

1. A Flashing Arrow sign shall be used for each lane closed.
- *2. Two lane closure signs (C-20) shall be used on the approach to a lane closure with speeds of 45 mph or greater.

NOTE: This chart based on 12-foot wide lanes.

For lane widths greater than 12 feet, use the following formulae:

Taper formula:

$$L = S \times W \text{ for speeds of 45 mph or more.}$$

$$L = \frac{WS^2}{60} \text{ for speeds of 40 mph or less.}$$

Where:

L = Minimum length of taper.

S = Numerical value of posted speed limit prior to work or 85 percentile speed.

W = Width of offset.

i.e.: 50 mph and 19' lane; $L = 50 \times 19 = 950$ feet

REV. APR-2010 C:\JTCM-DWG16.DWG

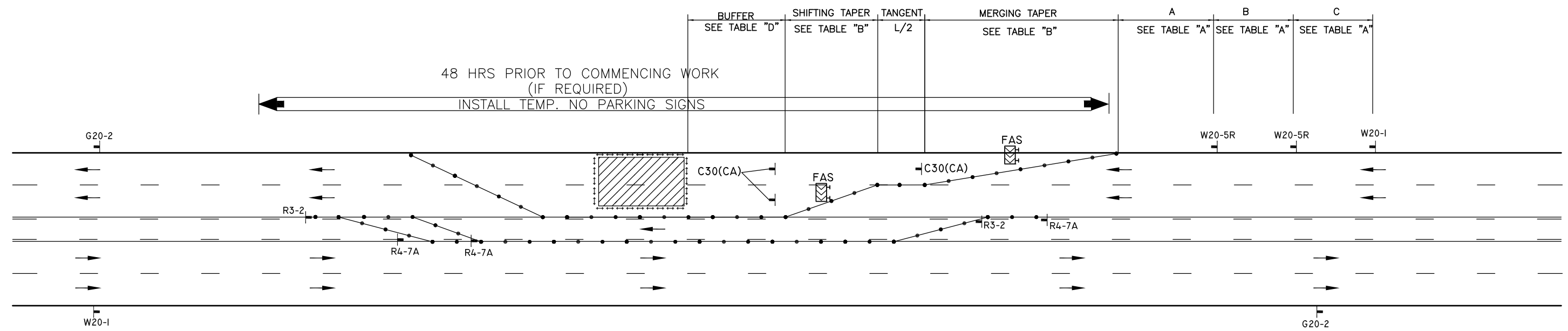

LEGEND

- TYPE III BARRICADE W/SIGN
- TYPE II BARRICADE W/O SIGN
- CHANNELIZING DEVICE
- TRAFFIC CONE WITH CLIP ON SIGN
- SIGN
- SIGNALIZED INTERSECTION
- ARROW PANEL (FLASHING ARROW) (WHERE REQUIRED)
- HIGH LEVEL WARNING DEVICE (FLAGTREE) (OPTIONAL)
- FLAGGER
- TANS TOW AWAY NO STOPPING ____ TO ____ (SHOW HOURS)
- TANSAT TOW AWAY NO STOPPING ANY TIME
- WORK ZONE (ACTIVITY AREA) LIMITS
- DIRECTION OF TRAFFIC (NOT PAVEMENT MARKING)
- ROADWAY DESIGNATION (A THROUGH D)

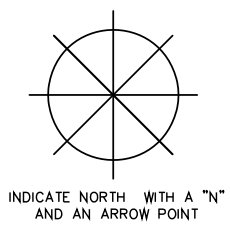
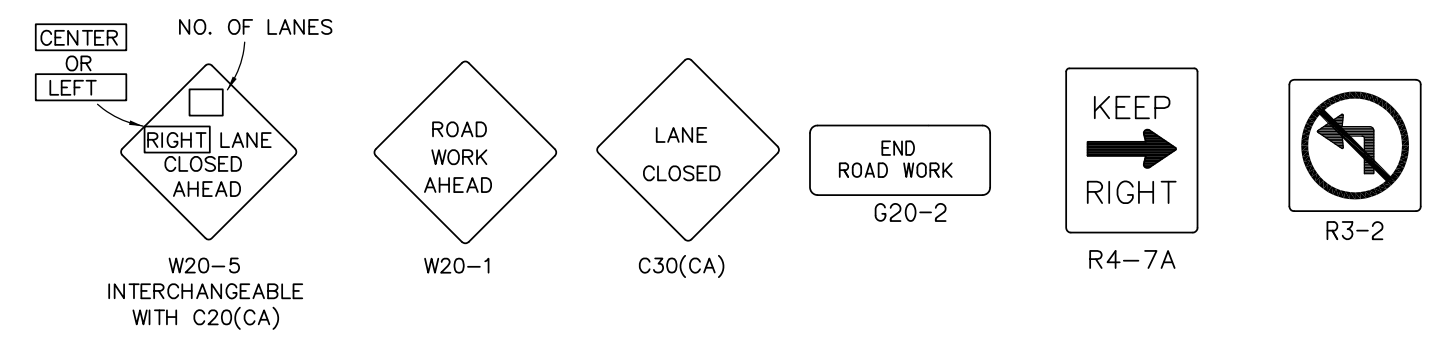

DATES OF TEMPORARY NO PARKING ZONE _____

WORKSITE TRAFFIC CONTROL PLAN
MIDBLOCK HALF STREET CLOSURE
USING LEFT TURN LANE AS TRAVELED LANE

DATE		SCALE	NONE
		DRAWING NO.	16



PLACEMENT OF BIKE LANE CLOSURE SIGN
(IF NECESSARY)

CONSTRUCTION NOTE:
ALL DRIVEWAYS TO REMAIN OPEN (WHENEVER POSSIBLE) THROUGHOUT TRAFFIC CONTROL ZONE

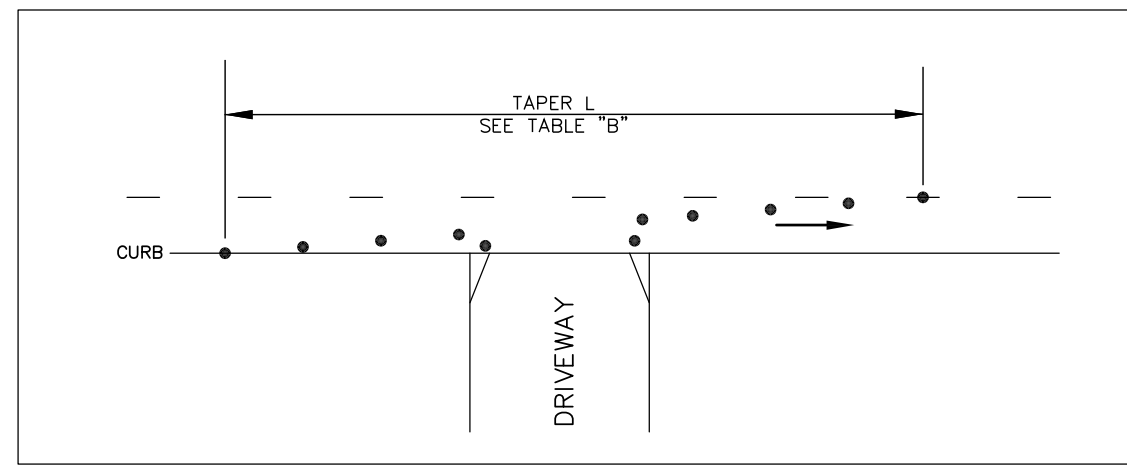

SEE TABLE 'A'-'F' FOR SIGN AND CHANNELIZER DEVICE SPACING AND TAPER LENGTH

SPEED	APPROACH STREET	TAPER LENGTH	SIGN SPACING	CHANNELIZER SPACING

SEE TABLE 'A'-'F' FOR SIGN AND CHANNELIZER DEVICE SPACING AND TAPER LENGTH

SPEED	APPROACH STREET	TAPER LENGTH	SIGN SPACING	CHANNELIZER SPACING

ABBREVIATIONS:

- S = Sign Spacing
- Min = Minimum
- LT = Left
- RT = Right
- LTP = Lane Traffic Panel
- TANSAT = Tow Away, No Stopping Anytime
- TANS = Tow Away, No Stopping

— CHART A —
MINIMUM RECOMMENDED DELINEATOR/CONE & SIGN PLACEMENT

POSTED SPEED LIMIT	TAPER LENGTH FOR 12-FT LANE			CHANNELIZER SPACING		SIGN SPACING (ADVANCE OF TAPER & BETWEEN SIGNS)
	MERGING	SHIFTING	SHOULDER	TAPER	TANGENT	
20 MPH	80 FT.	40 FT.	27 FT.	20 FT.	40 FT.	100 FT.
25 MPH	125 FT.	63 FT.	42 FT.	25 FT.	63 FT.	100 FT.
30 MPH	180 FT.	90 FT.	60 FT.	30 FT.	90 FT.	350 FT.
35 MPH	245 FT.	123 FT.	82 FT.	35 FT.	123 FT.	350 FT.
40 MPH	320 FT.	160 FT.	107 FT.	40 FT.	160 FT.	350 FT.
* 45 MPH	540 FT.	270 FT.	180 FT.	45 FT.	270 FT.	500 FT.
* 50 MPH	600 FT.	300 FT.	200 FT.	50 FT.	300 FT.	500 FT.
* 55+MPH	660 FT.	330 FT.	220 FT.	55 FT.	330 FT.	PER TABLE 'A'

NOTES

1. A Flashing Arrow sign shall be used for each lane closed.
- *2. Two lane closure signs (C-20) shall be used on the approach to a lane closure with speeds of 45 mph or greater.

NOTE: This chart based on 12-foot wide lanes.

For lane widths greater than 12 feet, use the following formulae:

Taper formula:

$$L = S \times W \text{ for speeds of 45 mph or more.}$$

$$L = \frac{WS^2}{60} \text{ for speeds of 40 mph or less.}$$

Where:

L = Minimum length of taper.

S = Numerical value of posted speed limit prior to work or 85 percentile speed.

W = Width of offset.

i.e.: 50 mph and 19' lane; $L = 50 \times 19 = 950$ feet

REV. APR-2010 C:\JITCM-DWG17.DWG

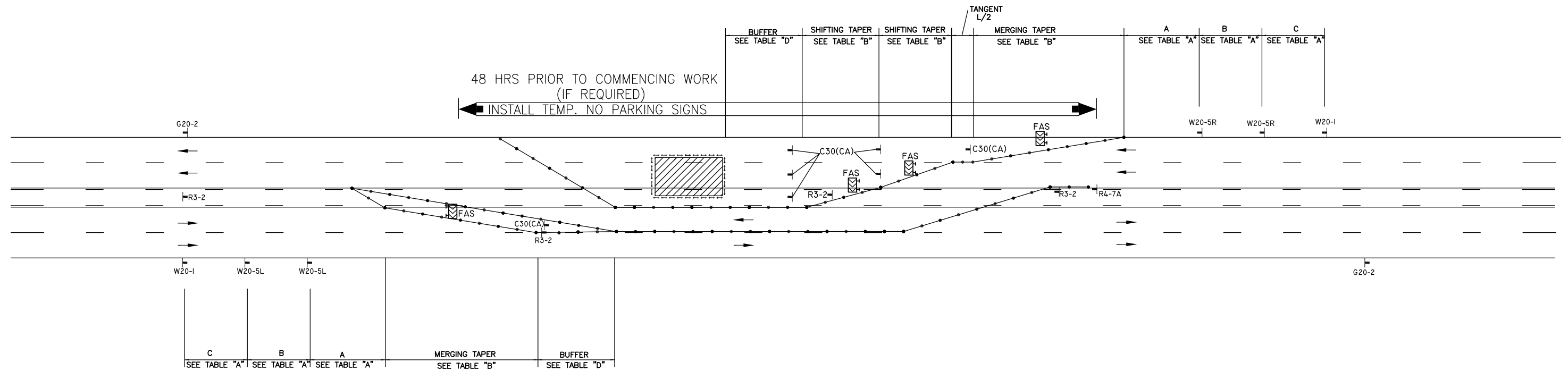

LEGEND

- TYPE III BARRICADE W/SIGN
- TYPE II BARRICADE W/O SIGN
- CHANNELIZING DEVICE
- TRAFFIC CONE WITH CLIP ON SIGN
- SIGN
- SIGNALIZED INTERSECTION
- ARROW PANEL (FLASHING ARROW) (WHERE REQUIRED)
- HIGH LEVEL WARNING DEVICE (FLAGTREE) (OPTIONAL)
- FLAGGER
- TANS TOW AWAY NO STOPPING ____ TO ____ (SHOW HOURS)
- TANSAT TOW AWAY NO STOPPING ANY TIME
- WORK ZONE (ACTIVITY AREA) LIMITS
- DIRECTION OF TRAFFIC (NOT PAVEMENT MARKING)
- ROADWAY DESIGNATION (A THROUGH D)

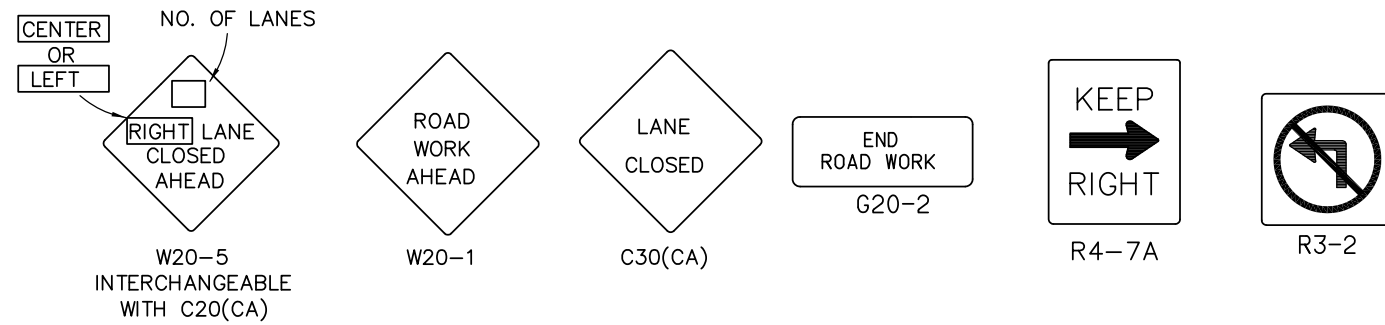

DATES OF TEMPORARY NO PARKING ZONE _____

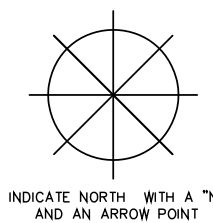

WORKSITE TRAFFIC CONTROL PLAN		
MULTILANE CLOSURE RIGHT LANES AND LEFT TURN LANES		
DATE		SCALE
		NONE
		DRAWING NO.
		17



CONSTRUCTION NOTE:
 ALL DRIVEWAYS TO REMAIN OPEN (WHENEVER POSSIBLE) THROUGHOUT TRAFFIC CONTROL ZONE

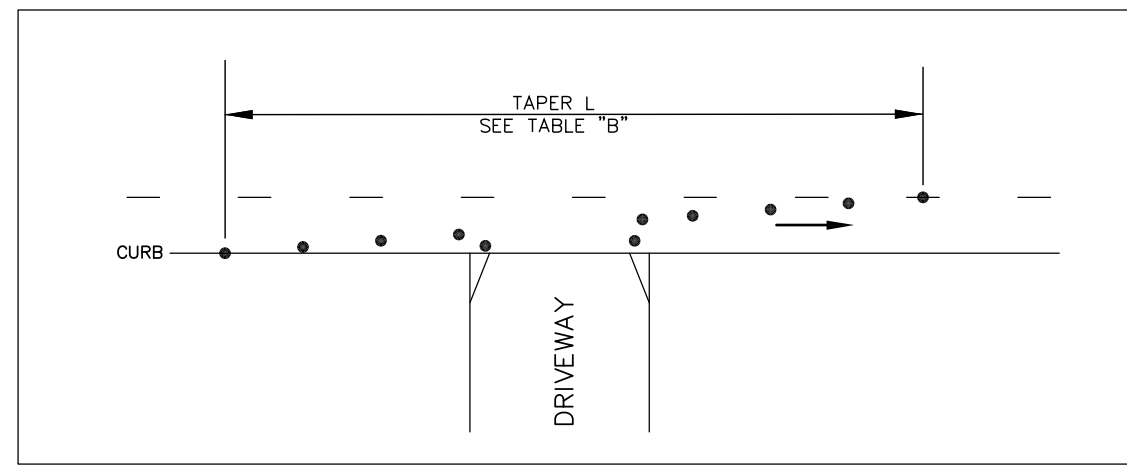

SEE TABLE 'A'-'F' FOR SIGN AND CHANNELIZER DEVICE SPACING AND TAPER LENGTH

SPEED	APPROACH STREET	TAPER LENGTH	SIGN SPACING	CHANNELIZER SPACING

SEE TABLE 'A'-'F' FOR SIGN AND CHANNELIZER DEVICE SPACING AND TAPER LENGTH

SPEED	APPROACH STREET	TAPER LENGTH	SIGN SPACING	CHANNELIZER SPACING

ABBREVIATIONS:

- S = Sign Spacing
- Min = Minimum
- LT = Left
- RT = Right
- LTP = Lane Traffic Panel
- TANSAT = Tow Away, No Stopping Anytime
- TANS = Tow Away, No Stopping

— CHART A —
 MINIMUM RECOMMENDED DELINEATOR/CONE & SIGN PLACEMENT

POSTED SPEED LIMIT	TAPER LENGTH FOR 12-FT LANE			CHANNELIZER SPACING		SIGN SPACING (ADVANCE OF TAPER & BETWEEN SIGNS)
	MERGING	SHIFTING	SHOULDER	TAPER	TANGENT	
20 MPH	80 FT.	40 FT.	27 FT.	20 FT.	40 FT.	100 FT.
25 MPH	125 FT.	63 FT.	42 FT.	25 FT.	63 FT.	100 FT.
30 MPH	180 FT.	90 FT.	60 FT.	30 FT.	90 FT.	350 FT.
35 MPH	245 FT.	123 FT.	82 FT.	35 FT.	123 FT.	350 FT.
40 MPH	320 FT.	160 FT.	107 FT.	40 FT.	160 FT.	350 FT.
* 45 MPH	540 FT.	270 FT.	180 FT.	45 FT.	270 FT.	500 FT.
* 50 MPH	600 FT.	300 FT.	200 FT.	50 FT.	300 FT.	500 FT.
* 55+MPH	660 FT.	330 FT.	220 FT.	55 FT.	330 FT.	PER TABLE 'A'

NOTES

1. A Flashing Arrow sign shall be used for each lane closed.
- *2. Two lane closure signs (C-20) shall be used on the approach to a lane closure with speeds of 45 mph or greater.

NOTE: This chart based on 12-foot wide lanes.

For lane widths greater than 12 feet, use the following formulae:

Taper formula:

$$L = S \times W \text{ for speeds of 45 mph or more.}$$

$$L = \frac{WS^2}{60} \text{ for speeds of 40 mph or less.}$$

Where:

L = Minimum length of taper.

S = Numerical value of posted speed limit prior to work or 85 percentile speed.

W = Width of offset.

i.e.: 50 mph and 19' lane; $L = 50 \times 19 = 950$ feet

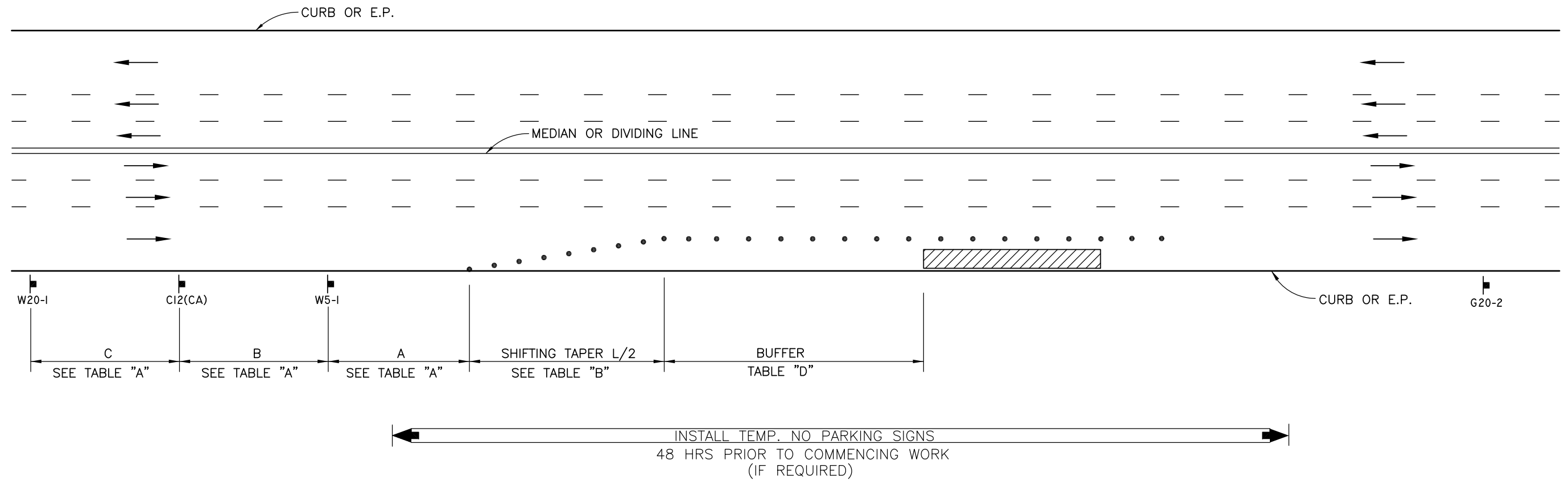

LEGEND

- TYPE III BARRICADE W/SIGN
- TYPE II BARRICADE W/O SIGN
- CHANNELIZING DEVICE
- TRAFFIC CONE WITH CLIP ON SIGN
- SIGN
- SIGNALIZED INTERSECTION
- ARROW PANEL (FLASHING ARROW) (WHERE REQUIRED)
- HIGH LEVEL WARNING DEVICE (FLAGTREE) (OPTIONAL)
- FLAGGER
- TANS TOW AWAY NO STOPPING ____ TO ____ (SHOW HOURS)
- TANSAT TOW AWAY NO STOPPING ANY TIME
- WORK ZONE (ACTIVITY AREA) LIMITS
- DIRECTION OF TRAFFIC (NOT PAVEMENT MARKING)
- ROADWAY DESIGNATION (A THROUGH D)

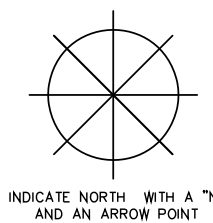
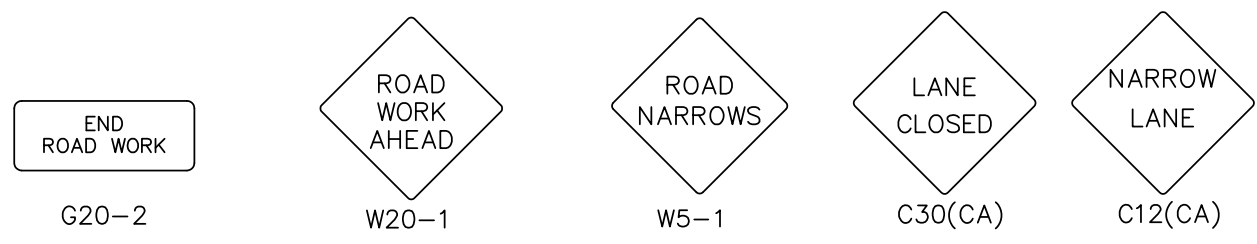

DATES OF TEMPORARY NO PARKING ZONE _____

WORKSITE TRAFFIC CONTROL PLAN
EDGE OF GUTTER CLOSURE

DATE		SCALE
		NONE
		DRAWING NO.
		18

REV. APR-2010 C:\JTCM-DWG18.DWG



CONSTRUCTION NOTE:
ALL DRIVEWAYS TO REMAIN OPEN (WHENEVER POSSIBLE) THROUGHOUT TRAFFIC CONTROL ZONE



SEE TABLE 'A'-'F' FOR SIGN AND CHANNELIZER DEVICE SPACING AND TAPER LENGTH

SPEED	APPROACH STREET	TAPER LENGTH	SIGN SPACING	CHANNELIZER SPACING

SEE TABLE 'A'-'F' FOR SIGN AND CHANNELIZER DEVICE SPACING AND TAPER LENGTH

SPEED	APPROACH STREET	TAPER LENGTH	SIGN SPACING	CHANNELIZER SPACING

ABBREVIATIONS:

- S = Sign Spacing
- Min = Minimum
- LT = Left
- RT = Right
- LTP = Lane Traffic Panel
- TANSAT = Tow Away, No Stopping Anytime
- TANS = Tow Away, No Stopping

— CHART A —
MINIMUM RECOMMENDED DELINEATOR/CONE & SIGN PLACEMENT

POSTED SPEED LIMIT	TAPER LENGTH FOR 12-FT LANE			CHANNELIZER SPACING		SIGN SPACING (ADVANCE OF TAPER & BETWEEN SIGNS)
	MERGING	SHIFTING	SHOULDER	TAPER	TANGENT	
20 MPH	80 FT.	40 FT.	27 FT.	20 FT.	40 FT.	100 FT.
25 MPH	125 FT.	63 FT.	42 FT.	25 FT.	63 FT.	100 FT.
30 MPH	180 FT.	90 FT.	60 FT.	30 FT.	90 FT.	350 FT.
35 MPH	245 FT.	123 FT.	82 FT.	35 FT.	123 FT.	350 FT.
40 MPH	320 FT.	160 FT.	107 FT.	40 FT.	160 FT.	350 FT.
* 45 MPH	540 FT.	270 FT.	180 FT.	45 FT.	270 FT.	500 FT.
* 50 MPH	600 FT.	300 FT.	200 FT.	50 FT.	300 FT.	500 FT.
* 55+MPH	660 FT.	330 FT.	220 FT.	55 FT.	330 FT.	PER TABLE 'A'

NOTES

1. A Flashing Arrow sign shall be used for each lane closed.
- *2. Two lane closure signs (C-20) shall be used on the approach to a lane closure with speeds of 45 mph or greater.

NOTE: This chart based on 12-foot wide lanes.

For lane widths greater than 12 feet, use the following formulae:

Taper formula:

$$L = S \times W \text{ for speeds of 45 mph or more.}$$

$$L = \frac{WS^2}{60} \text{ for speeds of 40 mph or less.}$$

Where:

L = Minimum length of taper.

S = Numerical value of posted speed limit prior to work or 85 percentile speed.

W = Width of offset.

i.e.: 50 mph and 19' lane; $L = 50 \times 19 = 950$ feet

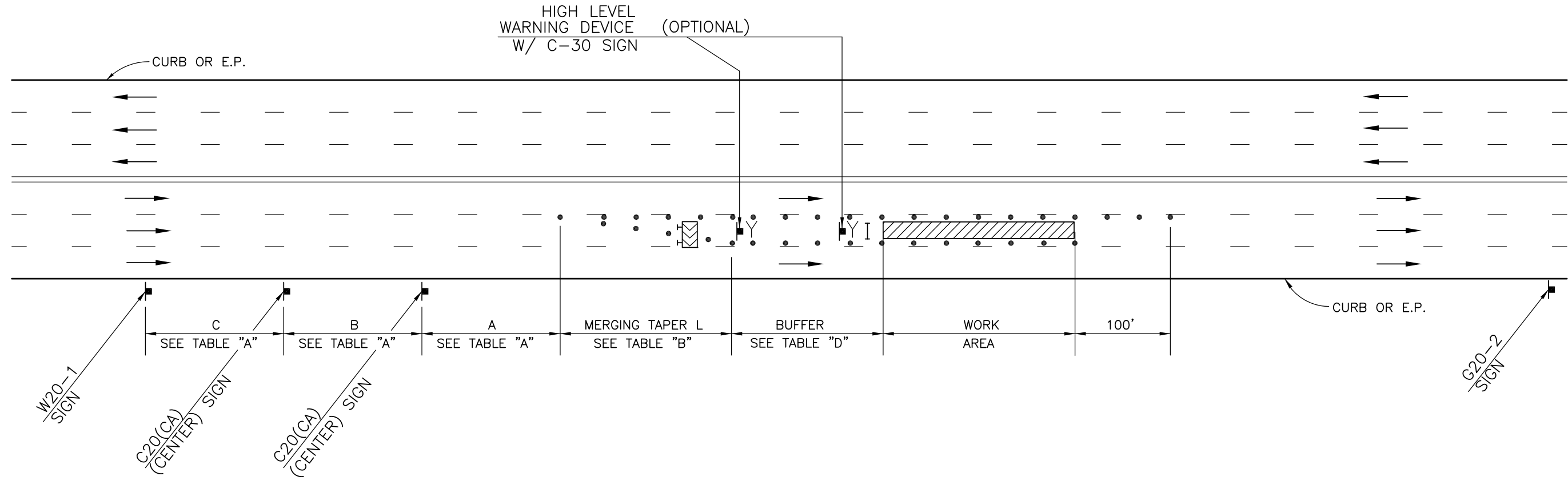

LEGEND

- TYPE III BARRICADE W/SIGN
- TYPE II BARRICADE W/O SIGN
- CHANNELIZING DEVICE
- TRAFFIC CONE WITH CLIP ON SIGN
- SIGN
- SIGNALIZED INTERSECTION
- ARROW PANEL (FLASHING ARROW) (WHERE REQUIRED)
- HIGH LEVEL WARNING DEVICE (FLAGTREE) (OPTIONAL)
- FLAGGER
- TANS TOW AWAY NO STOPPING ____ TO ____ (SHOW HOURS)
- TANSAT TOW AWAY NO STOPPING ANY TIME
- WORK ZONE (ACTIVITY AREA) LIMITS
- DIRECTION OF TRAFFIC (NOT PAVEMENT MARKING)
- ROADWAY DESIGNATION (A THROUGH D)

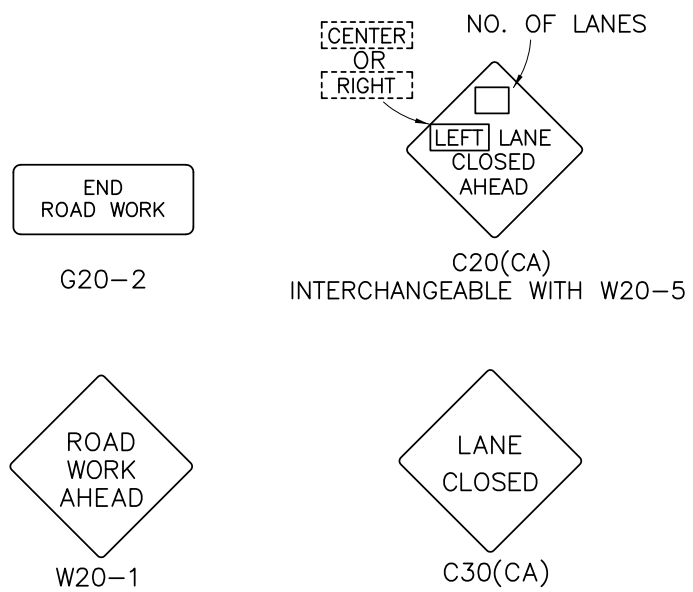

 DATES OF TEMPORARY NO PARKING ZONE

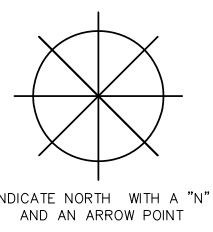

WORKSITE TRAFFIC CONTROL PLAN		
MIDDLE LANE CLOSURE		
DATE		SCALE
		NONE
		DRAWING NO.
		19

REV. APR-2010 C:\JUTCM-DWGS\19.DWG



CONSTRUCTION NOTE:
ALL DRIVEWAYS TO REMAIN OPEN (WHENEVER POSSIBLE) THROUGHOUT TRAFFIC CONTROL ZONE



SEE TABLE 'A'-'F' FOR SIGN AND CHANNELIZER DEVICE SPACING AND TAPER LENGTH

SPEED	APPROACH STREET	TAPER LENGTH	SIGN SPACING	CHANNELIZER SPACING

SEE TABLE 'A'-'F' FOR SIGN AND CHANNELIZER DEVICE SPACING AND TAPER LENGTH

SPEED	APPROACH STREET	TAPER LENGTH	SIGN SPACING	CHANNELIZER SPACING

ABBREVIATIONS:

- S = Sign Spacing
- Min = Minimum
- LT = Left
- RT = Right
- LTP = Lane Traffic Panel
- TANSAT = Tow Away, No Stopping Anytime
- TANS = Tow Away, No Stopping

— CHART A —
MINIMUM RECOMMENDED DELINEATOR/CONE & SIGN PLACEMENT

POSTED SPEED LIMIT	TAPER LENGTH FOR 12-FT LANE			CHANNELIZER SPACING		SIGN SPACING (ADVANCE OF TAPER & BETWEEN SIGNS)
	MERGING	SHIFTING	SHOULDER	TAPER	TANGENT	
20 MPH	80 FT.	40 FT.	27 FT.	20 FT.	40 FT.	100 FT.
25 MPH	125 FT.	63 FT.	42 FT.	25 FT.	63 FT.	100 FT.
30 MPH	180 FT.	90 FT.	60 FT.	30 FT.	90 FT.	350 FT.
35 MPH	245 FT.	123 FT.	82 FT.	35 FT.	123 FT.	350 FT.
40 MPH	320 FT.	160 FT.	107 FT.	40 FT.	160 FT.	350 FT.
* 45 MPH	540 FT.	270 FT.	180 FT.	45 FT.	270 FT.	500 FT.
* 50 MPH	600 FT.	300 FT.	200 FT.	50 FT.	300 FT.	500 FT.
* 55+MPH	660 FT.	330 FT.	220 FT.	55 FT.	330 FT.	PER TABLE 'A'

NOTES

1. A Flashing Arrow sign shall be used for each lane closed.
- *2. Two lane closure signs (C-20) shall be used on the approach to a lane closure with speeds of 45 mph or greater.

NOTE: This chart based on 12-foot wide lanes.

For lane widths greater than 12 feet, use the following formulae:

Taper formula:

$$L = S \times W \text{ for speeds of 45 mph or more.}$$

$$L = \frac{WS^2}{60} \text{ for speeds of 40 mph or less.}$$

Where:

L = Minimum length of taper.

S = Numerical value of posted speed limit prior to work or 85 percentile speed.

W = Width of offset.

i.e.: 50 mph and 19' lane; $L = 50 \times 19 = 950$ feet

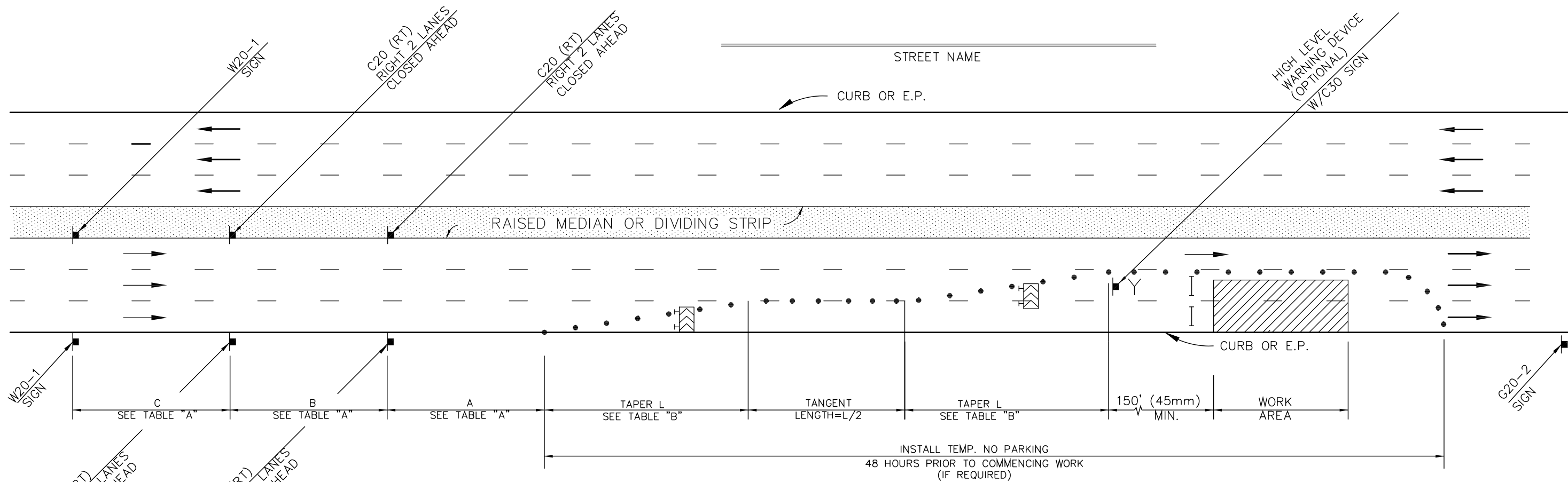

LEGEND

- TYPE III BARRICADE W/SIGN
- TYPE II BARRICADE W/O SIGN
- 28"(11cm) TRAFFIC CONES W/13"(5cm) REFLECTIVE SLEEVE FOR DAY/NIGHT USE OR DELINEATORS IF DAY USE ONLY
- TRAFFIC CONE WITH CLIP ON SIGN
- PROPOSED SIGN AND POST
- EXISTING SIGN AND POST
- SIGNALIZED INTERSECTION
- FLASHING ARROW SIGN
- HIGH LEVEL WARNING DEVICE WITH SIGN
- FLAGGER
- TANS TOW AWAY NO STOPPING ____ TO ____ (SHOW HOURS)
- TANSAT TOW AWAY NO STOPPING ANY TIME
- WORK ZONE LIMITS
- DIRECTION OF TRAFFIC
- ROADWAY DESIGNATION (A THROUGH D)

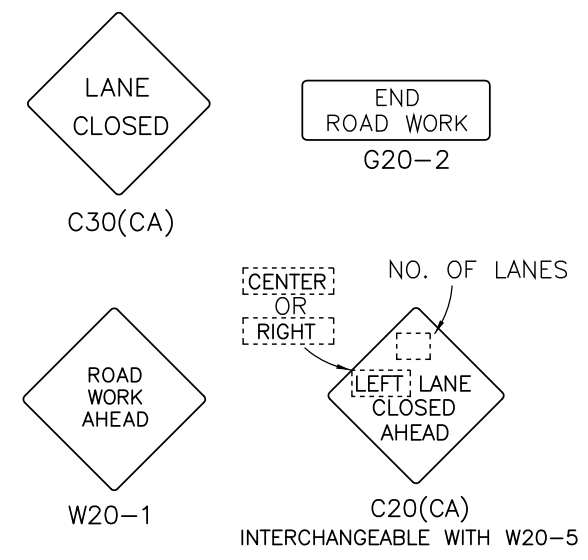

DATES OF TEMPORARY NO PARKING ZONE

WORKSITE TRAFFIC CONTROL PLAN MULTI LANE CLOSURE (RIGHT LANE)		
DATE		SCALE
		NONE
		DRAWING NO.
		20

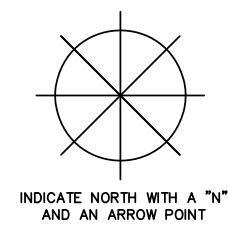

REV. APR-2010 C:\JUTCM-DWG20.DWG



CONSTRUCTION NOTE:
ALL DRIVEWAYS TO REMAIN OPEN (WHENEVER POSSIBLE) THROUGHOUT TRAFFIC CONTROL ZONE



SEE TABLE 'A'-'F' FOR SIGN AND CHANNELIZER DEVICE SPACING AND TAPER LENGTH

SPEED	APPROACH STREET	TAPER LENGTH	SIGN SPACING	CHANNELIZER SPACING

SEE TABLE 'A'-'F' FOR SIGN AND CHANNELIZER DEVICE SPACING AND TAPER LENGTH

SPEED	APPROACH STREET	TAPER LENGTH	SIGN SPACING	CHANNELIZER SPACING

ABBREVIATIONS:

- S = Sign Spacing
- Min = Minimum
- LT = Left
- RT = Right
- LTP = Lane Traffic Panel
- TANSAT = Tow Away, No Stopping Anytime
- TANS = Tow Away, No Stopping

— CHART A —
MINIMUM RECOMMENDED DELINEATOR/CONE & SIGN PLACEMENT

POSTED SPEED LIMIT	TAPER LENGTH FOR 12-FT LANE			CHANNELIZER SPACING		SIGN SPACING (ADVANCE OF TAPER & BETWEEN SIGNS)
	MERGING	SHIFTING	SHOULDER	TAPER	TANGENT	
20 MPH	80 FT.	40 FT.	27 FT.	20 FT.	40 FT.	100 FT.
25 MPH	125 FT.	63 FT.	42 FT.	25 FT.	63 FT.	100 FT.
30 MPH	180 FT.	90 FT.	60 FT.	30 FT.	90 FT.	350 FT.
35 MPH	245 FT.	123 FT.	82 FT.	35 FT.	123 FT.	350 FT.
40 MPH	320 FT.	160 FT.	107 FT.	40 FT.	160 FT.	350 FT.
* 45 MPH	540 FT.	270 FT.	180 FT.	45 FT.	270 FT.	500 FT.
* 50 MPH	600 FT.	300 FT.	200 FT.	50 FT.	300 FT.	500 FT.
* 55+MPH	660 FT.	330 FT.	220 FT.	55 FT.	330 FT.	PER TABLE 'A'

NOTES

1. A Flashing Arrow sign shall be used for each lane closed.
- *2. Two lane closure signs (C-20) shall be used on the approach to a lane closure with speeds of 45 mph or greater.

NOTE: This chart based on 12-foot wide lanes.

For lane widths greater than 12 feet, use the following formulae:

Taper formula:

$$L = S \times W \text{ for speeds of 45 mph or more.}$$

$$L = \frac{WS^2}{60} \text{ for speeds of 40 mph or less.}$$

Where:

- L = Minimum length of taper.
- S = Numerical value of posted speed limit prior to work or 85 percentile speed.
- W = Width of offset.

i.e.: 50 mph and 19' lane; $L = 50 \times 19 = 950$ feet

REV. APR-2010 C:\JITCM-DWG21.DWG

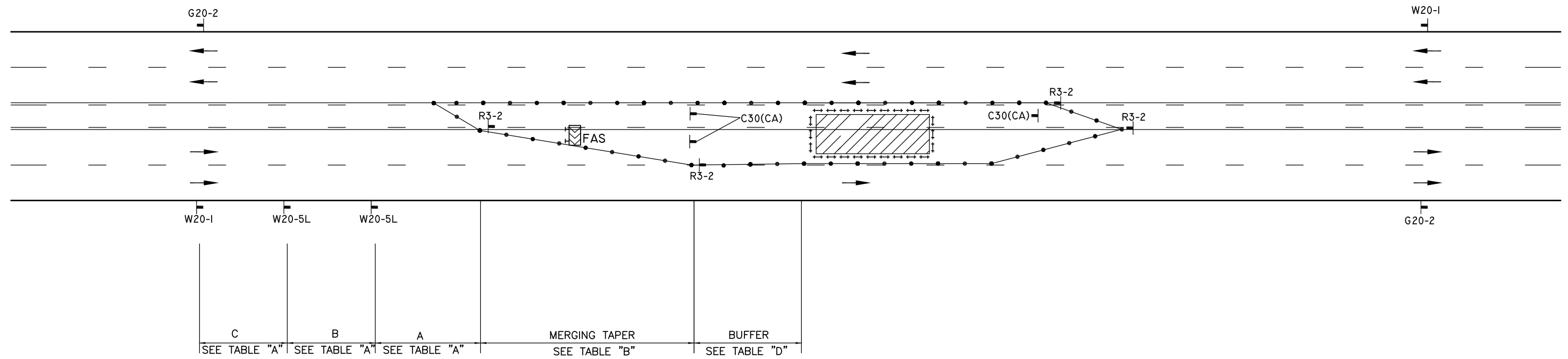

LEGEND

- TYPE III BARRICADE W/SIGN
- TYPE II BARRICADE W/O SIGN
- CHANNELIZING DEVICE
- TRAFFIC CONE WITH CLIP ON SIGN
- SIGN
- SIGNALIZED INTERSECTION
- ARROW PANEL (FLASHING ARROW) (WHERE REQUIRED)
- HIGH LEVEL WARNING DEVICE (FLAGTREE) (OPTIONAL)
- FLAGGER
- TANS TOW AWAY NO STOPPING ____ TO ____ (SHOW HOURS)
- TANSAT TOW AWAY NO STOPPING ANY TIME
- WORK ZONE (ACTIVITY AREA) LIMITS
- DIRECTION OF TRAFFIC (NOT PAVEMENT MARKING)
- ROADWAY DESIGNATION (A THROUGH D)

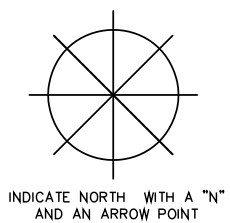
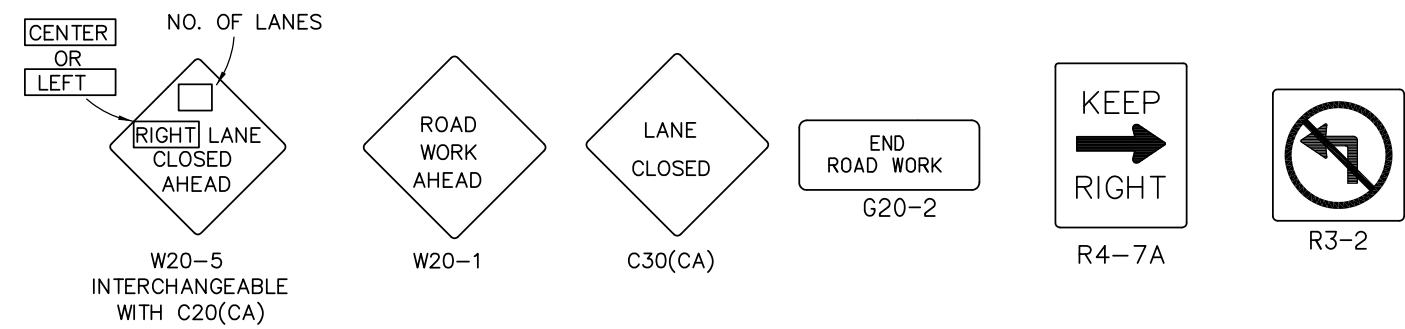

DATES OF TEMPORARY NO PARKING ZONE		
WORKSITE TRAFFIC CONTROL PLAN MIDBLOCK NO. 1 LANE AND LEFT TURN LANE CLOSURE		
DATE		SCALE
		NONE
		DRAWING NO.
		21



CONSTRUCTION NOTE:
 ALL DRIVEWAYS TO REMAIN OPEN (WHENEVER POSSIBLE) THROUGHOUT TRAFFIC CONTROL ZONE

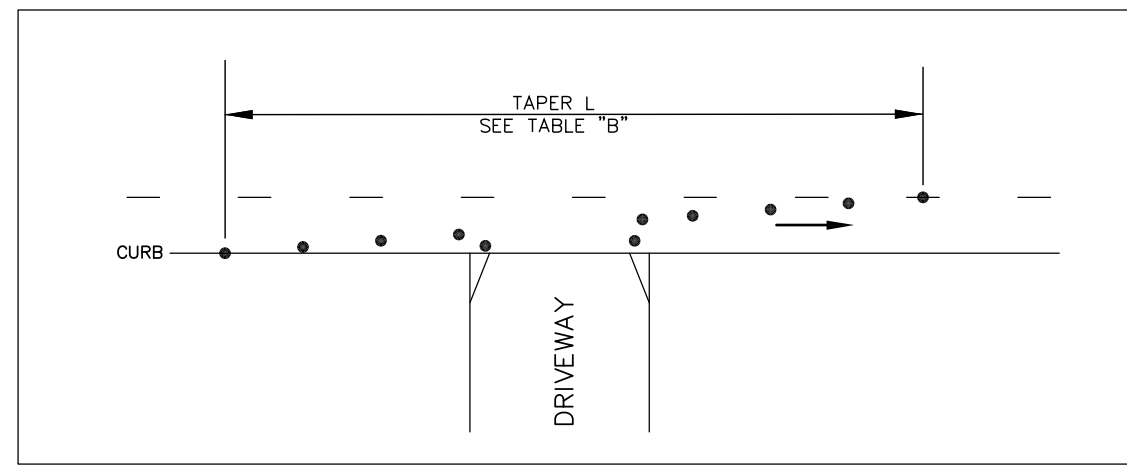

SEE TABLE 'A'-'F' FOR SIGN AND CHANNELIZER DEVICE SPACING AND TAPER LENGTH

SPEED	APPROACH STREET	TAPER LENGTH	SIGN SPACING	CHANNELIZER SPACING

SEE TABLE 'A'-'F' FOR SIGN AND CHANNELIZER DEVICE SPACING AND TAPER LENGTH

SPEED	APPROACH STREET	TAPER LENGTH	SIGN SPACING	CHANNELIZER SPACING

ABBREVIATIONS:

- S = Sign Spacing
- Min = Minimum
- LT = Left
- RT = Right
- LTP = Lane Traffic Panel
- TANSAT = Tow Away, No Stopping Anytime
- TANS = Tow Away, No Stopping

— CHART A —
 MINIMUM RECOMMENDED DELINEATOR/CONE & SIGN PLACEMENT

POSTED SPEED LIMIT	TAPER LENGTH FOR 12-FT LANE			CHANNELIZER SPACING		SIGN SPACING (ADVANCE OF TAPER & BETWEEN SIGNS)
	MERGING	SHIFTING	SHOULDER	TAPER	TANGENT	
20 MPH	80 FT.	40 FT.	27 FT.	20 FT.	40 FT.	100 FT.
25 MPH	125 FT.	63 FT.	42 FT.	25 FT.	63 FT.	100 FT.
30 MPH	180 FT.	90 FT.	60 FT.	30 FT.	90 FT.	350 FT.
35 MPH	245 FT.	123 FT.	82 FT.	35 FT.	123 FT.	350 FT.
40 MPH	320 FT.	160 FT.	107 FT.	40 FT.	160 FT.	350 FT.
* 45 MPH	540 FT.	270 FT.	180 FT.	45 FT.	270 FT.	500 FT.
* 50 MPH	600 FT.	300 FT.	200 FT.	50 FT.	300 FT.	500 FT.
* 55+MPH	660 FT.	330 FT.	220 FT.	55 FT.	330 FT.	PER TABLE 'A'

NOTES

1. A Flashing Arrow sign shall be used for each lane closed.
- *2. Two lane closure signs (C-20) shall be used on the approach to a lane closure with speeds of 45 mph or greater.

NOTE: This chart based on 12-foot wide lanes.

For lane widths greater than 12 feet, use the following formulae:

Taper formula:

$$L = S \times W \text{ for speeds of 45 mph or more.}$$

$$L = \frac{WS^2}{60} \text{ for speeds of 40 mph or less.}$$

Where:

L = Minimum length of taper.

S = Numerical value of posted speed limit prior to work or 85 percentile speed.

W = Width of offset.

i.e.: 50 mph and 19' lane; $L = 50 \times 19 = 950$ feet

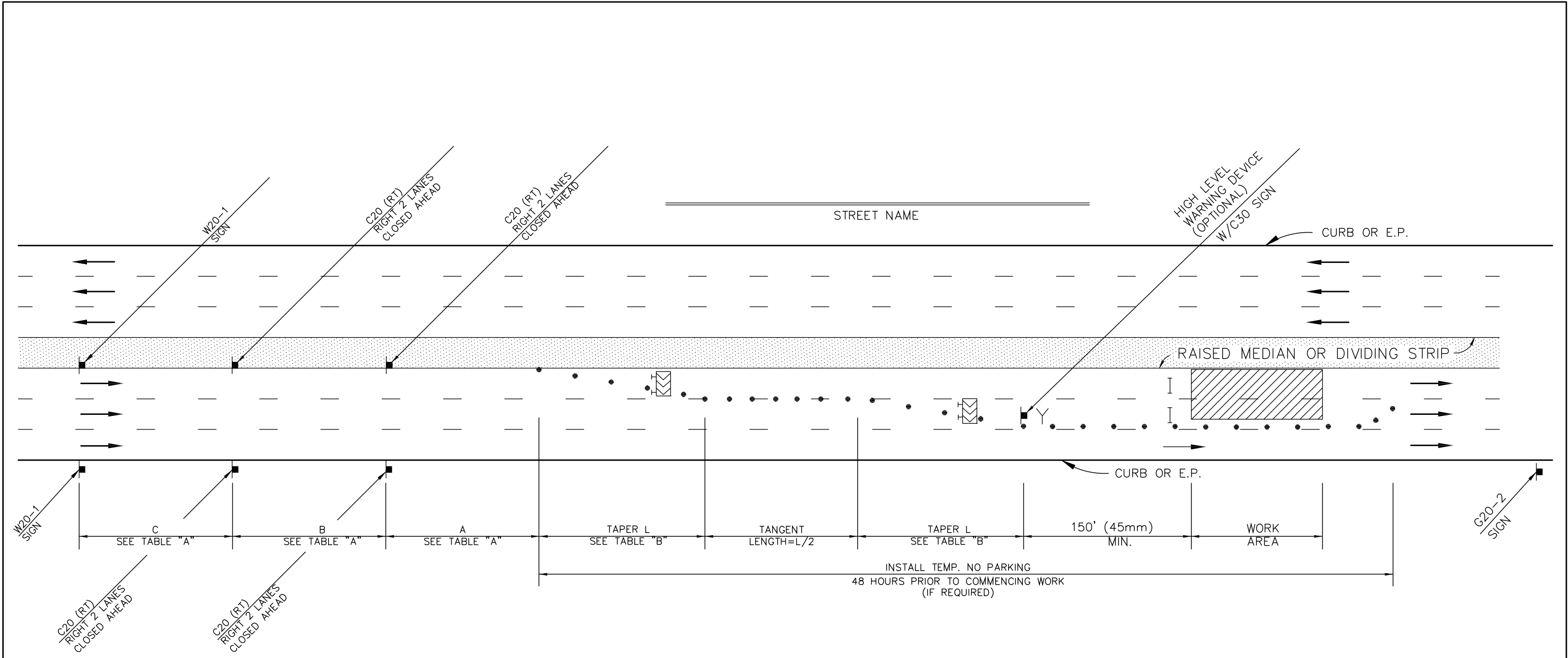

LEGEND

- TYPE III BARRICADE W/SIGN
- TYPE II BARRICADE W/O SIGN
- 28"(11cm) TRAFFIC CONES W/13"(5cm) REFLECTIVE SLEEVE FOR DAY/NIGHT USE OR DELINEATORS IF DAY USE ONLY
- TRAFFIC CONE WITH CLIP ON SIGN
- PROPOSED SIGN AND POST
- EXISTING SIGN AND POST
- SIGNALIZED INTERSECTION
- FLASHING ARROW SIGN
- HIGH LEVEL WARNING DEVICE WITH SIGN
- FLAGGER
- TANS TOW AWAY NO STOPPING ___ TO ___ (SHOW HOURS)
- TANSAT TOW AWAY NO STOPPING ANY TIME
- WORK ZONE LIMITS
- DIRECTION OF TRAFFIC
- ROADWAY DESIGNATION (A THROUGH D)

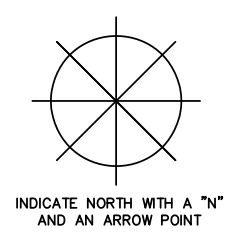
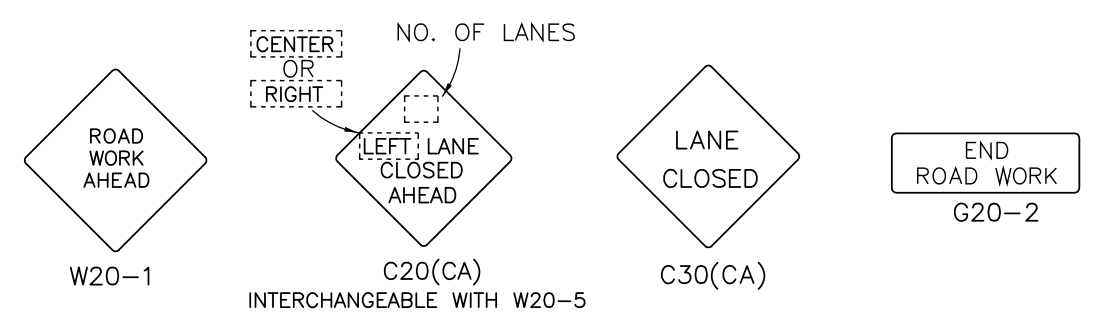

DATES OF TEMPORARY NO PARKING ZONE _____

**WORKSITE TRAFFIC CONTROL PLAN
MULTI LANE CLOSURE
(LEFT LANES)**

DATE		SCALE	NONE
		DRAWING NO.	22

REV. APR-2010 C:\JUTCM-DWG22.DWG



CONSTRUCTION NOTE:
ALL DRIVEWAYS TO REMAIN OPEN (WHENEVER POSSIBLE) THROUGHOUT TRAFFIC CONTROL ZONE



SEE TABLE 'A'-'F' FOR SIGN AND CHANNELIZER DEVICE SPACING AND TAPER LENGTH

SPEED	APPROACH STREET	TAPER LENGTH	SIGN SPACING	CHANNELIZER SPACING

SEE TABLE 'A'-'F' FOR SIGN AND CHANNELIZER DEVICE SPACING AND TAPER LENGTH

SPEED	APPROACH STREET	TAPER LENGTH	SIGN SPACING	CHANNELIZER SPACING

ABBREVIATIONS:

- S = Sign Spacing
- Min = Minimum
- LT = Left
- RT = Right
- LTP = Lane Traffic Panel
- TANSAT = Tow Away, No Stopping Anytime
- TANS = Tow Away, No Stopping

— CHART A —
MINIMUM RECOMMENDED DELINEATOR/CONE & SIGN PLACEMENT

POSTED SPEED LIMIT	TAPER LENGTH FOR 12-FT LANE			CHANNELIZER SPACING		SIGN SPACING (ADVANCE OF TAPER & BETWEEN SIGNS)
	MERGING	SHIFTING	SHOULDER	TAPER	TANGENT	
20 MPH	80 FT.	40 FT.	27 FT.	20 FT.	40 FT.	100 FT.
25 MPH	125 FT.	63 FT.	42 FT.	25 FT.	63 FT.	100 FT.
30 MPH	180 FT.	90 FT.	60 FT.	30 FT.	90 FT.	350 FT.
35 MPH	245 FT.	123 FT.	82 FT.	35 FT.	123 FT.	350 FT.
40 MPH	320 FT.	160 FT.	107 FT.	40 FT.	160 FT.	350 FT.
* 45 MPH	540 FT.	270 FT.	180 FT.	45 FT.	270 FT.	500 FT.
* 50 MPH	600 FT.	300 FT.	200 FT.	50 FT.	300 FT.	500 FT.
* 55+MPH	660 FT.	330 FT.	220 FT.	55 FT.	330 FT.	PER TABLE 'A'

NOTES

1. A Flashing Arrow sign shall be used for each lane closed.
- *2. Two lane closure signs (C-20) shall be used on the approach to a lane closure with speeds of 45 mph or greater.

NOTE: This chart based on 12-foot wide lanes.

For lane widths greater than 12 feet, use the following formulae:

Taper formula:

$$L = S \times W \text{ for speeds of 45 mph or more.}$$

$$L = \frac{WS^2}{60} \text{ for speeds of 40 mph or less.}$$

Where:

L = Minimum length of taper.

S = Numerical value of posted speed limit prior to work or 85 percentile speed.

W = Width of offset.

i.e.: 50 mph and 19' lane; $L = 50 \times 19 = 950$ feet

REV. APR-2010 C:\JUTCM-DWG523.DWG

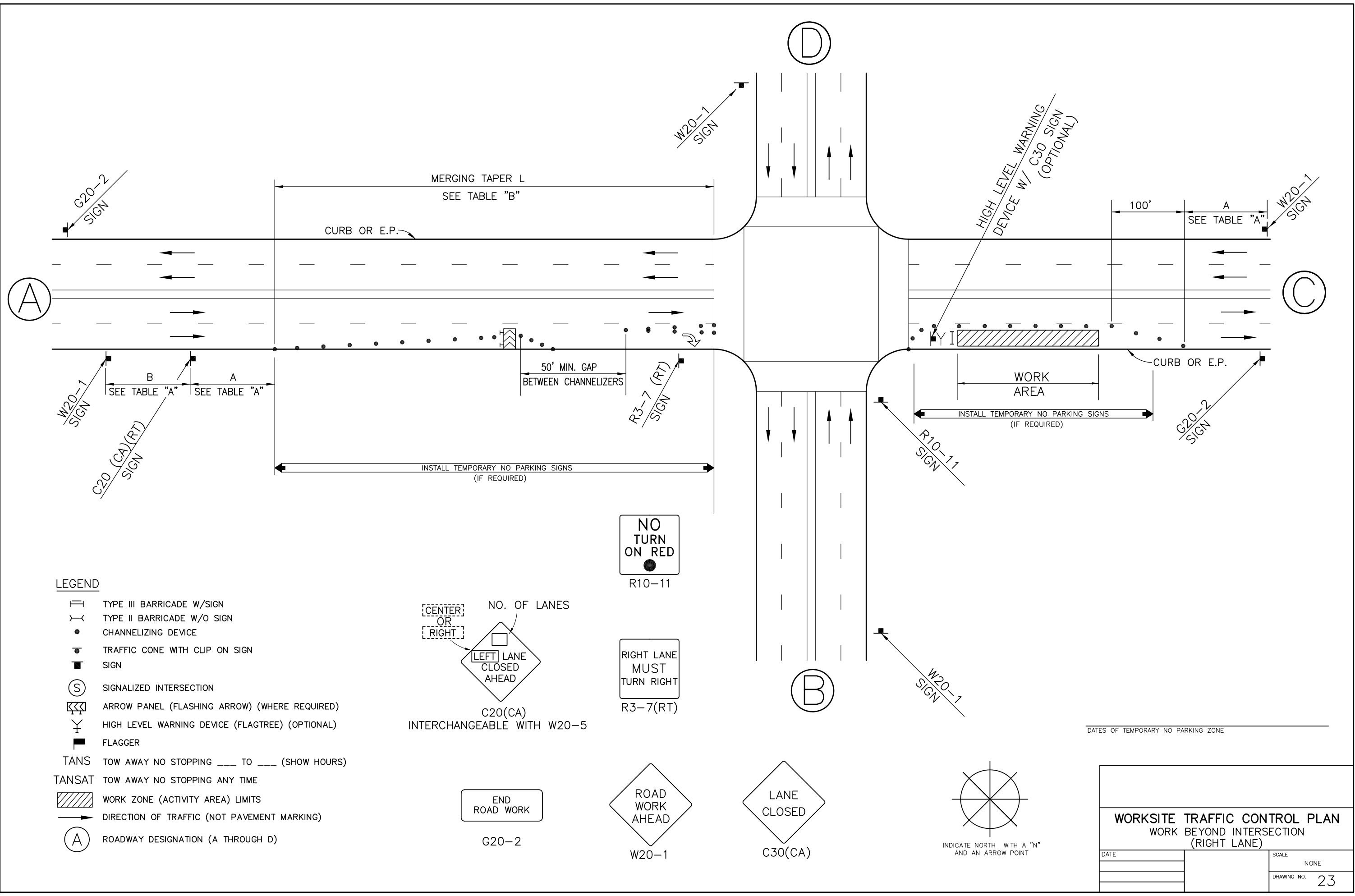

LEGEND

- TYPE III BARRICADE W/SIGN
- TYPE II BARRICADE W/O SIGN
- CHANNELIZING DEVICE
- TRAFFIC CONE WITH CLIP ON SIGN
- SIGN
- SIGNALIZED INTERSECTION
- ARROW PANEL (FLASHING ARROW) (WHERE REQUIRED)
- HIGH LEVEL WARNING DEVICE (FLAGTREE) (OPTIONAL)
- FLAGGER
- TANS TOW AWAY NO STOPPING ____ TO ____ (SHOW HOURS)
- TANSAT TOW AWAY NO STOPPING ANY TIME
- WORK ZONE (ACTIVITY AREA) LIMITS
- DIRECTION OF TRAFFIC (NOT PAVEMENT MARKING)
- ROADWAY DESIGNATION (A THROUGH D)

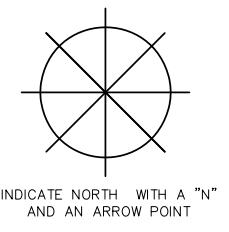
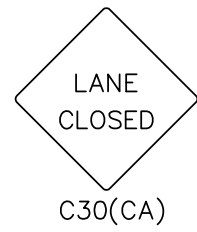
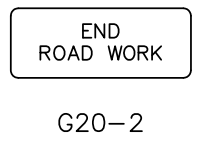
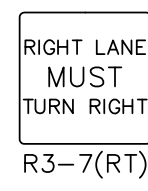
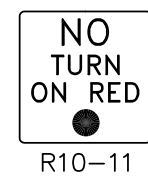
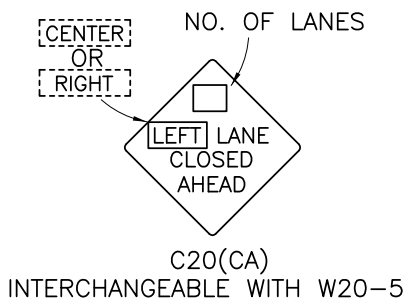

DATES OF TEMPORARY NO PARKING ZONE _____

WORKSITE TRAFFIC CONTROL PLAN		
WORK BEYOND INTERSECTION (RIGHT LANE)		
DATE		SCALE
		NONE
		DRAWING NO.
		23



CONSTRUCTION NOTE:
ALL DRIVEWAYS TO REMAIN OPEN (WHENEVER POSSIBLE) THROUGHOUT TRAFFIC CONTROL ZONE



SEE TABLE 'A'-'F' FOR SIGN AND CHANNELIZER DEVICE SPACING AND TAPER LENGTH

SPEED	APPROACH STREET	TAPER LENGTH	SIGN SPACING	CHANNELIZER SPACING

SEE TABLE 'A'-'F' FOR SIGN AND CHANNELIZER DEVICE SPACING AND TAPER LENGTH

SPEED	APPROACH STREET	TAPER LENGTH	SIGN SPACING	CHANNELIZER SPACING

ABBREVIATIONS:

- S = Sign Spacing
- Min = Minimum
- LT = Left
- RT = Right
- LTP = Lane Traffic Panel
- TANSAT = Tow Away, No Stopping Anytime
- TANS = Tow Away, No Stopping

— CHART A —
MINIMUM RECOMMENDED DELINEATOR/CONE & SIGN PLACEMENT

POSTED SPEED LIMIT	TAPER LENGTH FOR 12-FT LANE			CHANNELIZER SPACING		SIGN SPACING (ADVANCE OF TAPER & BETWEEN SIGNS)
	MERGING	SHIFTING	SHOULDER	TAPER	TANGENT	
20 MPH	80 FT.	40 FT.	27 FT.	20 FT.	40 FT.	100 FT.
25 MPH	125 FT.	63 FT.	42 FT.	25 FT.	63 FT.	100 FT.
30 MPH	180 FT.	90 FT.	60 FT.	30 FT.	90 FT.	350 FT.
35 MPH	245 FT.	123 FT.	82 FT.	35 FT.	123 FT.	350 FT.
40 MPH	320 FT.	160 FT.	107 FT.	40 FT.	160 FT.	350 FT.
* 45 MPH	540 FT.	270 FT.	180 FT.	45 FT.	270 FT.	500 FT.
* 50 MPH	600 FT.	300 FT.	200 FT.	50 FT.	300 FT.	500 FT.
* 55+MPH	660 FT.	330 FT.	220 FT.	55 FT.	330 FT.	PER TABLE 'A'

NOTES

1. A Flashing Arrow sign shall be used for each lane closed.
- *2. Two lane closure signs (C-20) shall be used on the approach to a lane closure with speeds of 45 mph or greater.

NOTE: This chart based on 12-foot wide lanes.

For lane widths greater than 12 feet, use the following formulae:

Taper formula:

$$L = S \times W \text{ for speeds of 45 mph or more.}$$

$$L = \frac{WS^2}{60} \text{ for speeds of 40 mph or less.}$$

Where:

L = Minimum length of taper.

S = Numerical value of posted speed limit prior to work or 85 percentile speed.

W = Width of offset.

i.e.: 50 mph and 19' lane; $L = 50 \times 19 = 950$ feet

REV. APR-2010 C:\JUTCM-DWG24.DWG

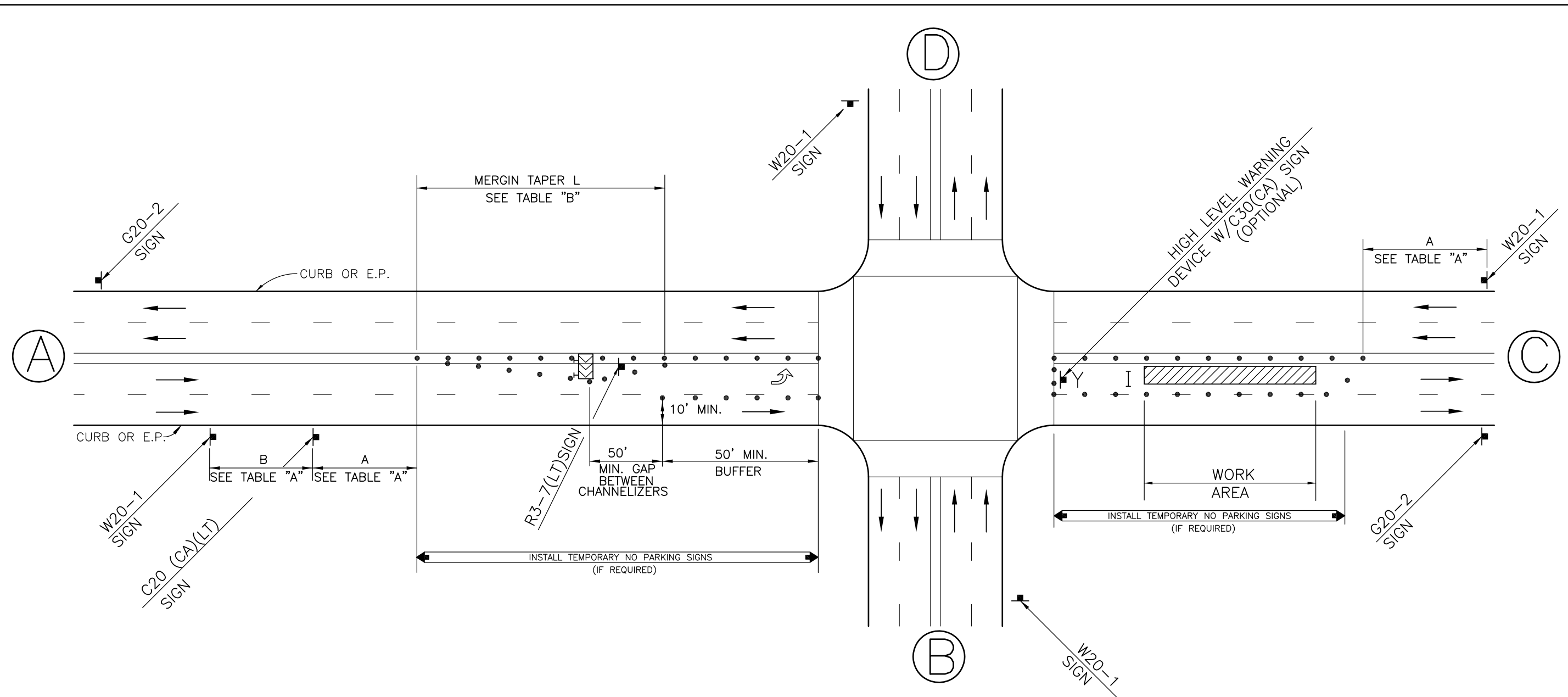

LEGEND

- TYPE III BARRICADE W/SIGN
- TYPE II BARRICADE W/O SIGN
- CHANNELIZING DEVICE
- TRAFFIC CONE WITH CLIP ON SIGN
- SIGN
- SIGNALIZED INTERSECTION
- ARROW PANEL (FLASHING ARROW) (WHERE REQUIRED)
- HIGH LEVEL WARNING DEVICE (FLAGTREE) (OPTIONAL)
- FLAGGER
- TANS TOW AWAY NO STOPPING ____ TO ____ (SHOW HOURS)
- TANSAT TOW AWAY NO STOPPING ANY TIME
- WORK ZONE (ACTIVITY AREA) LIMITS
- DIRECTION OF TRAFFIC (NOT PAVEMENT MARKING)
- ROADWAY DESIGNATION (A THROUGH D)

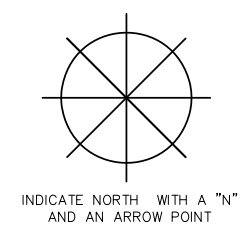
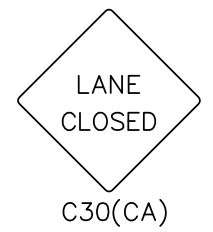
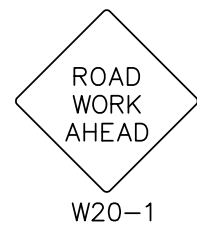
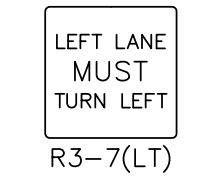
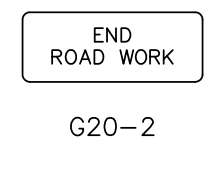
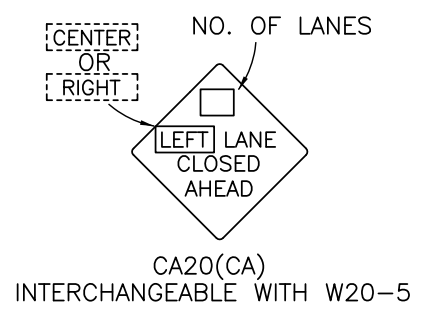

DATES OF TEMPORARY NO PARKING ZONE

WORKSITE TRAFFIC CONTROL PLAN		
WORK BEYOND INTERSECTION (LEFT LANE)		
DATE		SCALE
		NONE
		DRAWING NO.
		24



CONSTRUCTION NOTE:
ALL DRIVEWAYS TO REMAIN OPEN (WHENEVER POSSIBLE) THROUGHOUT TRAFFIC CONTROL ZONE



SEE TABLE 'A'-'F' FOR SIGN AND CHANNELIZER DEVICE SPACING AND TAPER LENGTH

SPEED	APPROACH STREET	TAPER LENGTH	SIGN SPACING	CHANNELIZER SPACING

SEE TABLE 'A'-'F' FOR SIGN AND CHANNELIZER DEVICE SPACING AND TAPER LENGTH

SPEED	APPROACH STREET	TAPER LENGTH	SIGN SPACING	CHANNELIZER SPACING

ABBREVIATIONS:

- S = Sign Spacing
- Min = Minimum
- LT = Left
- RT = Right
- LTP = Lane Traffic Panel
- TANSAT = Tow Away, No Stopping Anytime
- TANS = Tow Away, No Stopping

— CHART A —
MINIMUM RECOMMENDED DELINEATOR/CONE & SIGN PLACEMENT

POSTED SPEED LIMIT	TAPER LENGTH FOR 12-FT LANE			CHANNELIZER SPACING		SIGN SPACING (ADVANCE OF TAPER & BETWEEN SIGNS)
	MERGING	SHIFTING	SHOULDER	TAPER	TANGENT	
20 MPH	80 FT.	40 FT.	27 FT.	20 FT.	40 FT.	100 FT.
25 MPH	125 FT.	63 FT.	42 FT.	25 FT.	63 FT.	100 FT.
30 MPH	180 FT.	90 FT.	60 FT.	30 FT.	90 FT.	350 FT.
35 MPH	245 FT.	123 FT.	82 FT.	35 FT.	123 FT.	350 FT.
40 MPH	320 FT.	160 FT.	107 FT.	40 FT.	160 FT.	350 FT.
* 45 MPH	540 FT.	270 FT.	180 FT.	45 FT.	270 FT.	500 FT.
* 50 MPH	600 FT.	300 FT.	200 FT.	50 FT.	300 FT.	500 FT.
* 55+MPH	660 FT.	330 FT.	220 FT.	55 FT.	330 FT.	PER TABLE 'A'

NOTES

1. A Flashing Arrow sign shall be used for each lane closed.
- *2. Two lane closure signs (C-20) shall be used on the approach to a lane closure with speeds of 45 mph or greater.

NOTE: This chart based on 12-foot wide lanes.

For lane widths greater than 12 feet, use the following formulae:

Taper formula:

$$L = S \times W \text{ for speeds of 45 mph or more.}$$

$$L = \frac{WS^2}{60} \text{ for speeds of 40 mph or less.}$$

Where:

L = Minimum length of taper.

S = Numerical value of posted speed limit prior to work or 85 percentile speed.

W = Width of offset.

i.e.: 50 mph and 19' lane; $L = 50 \times 19 = 950$ feet

REV. APR-2010 C:\JTCM-DWG25.DWG

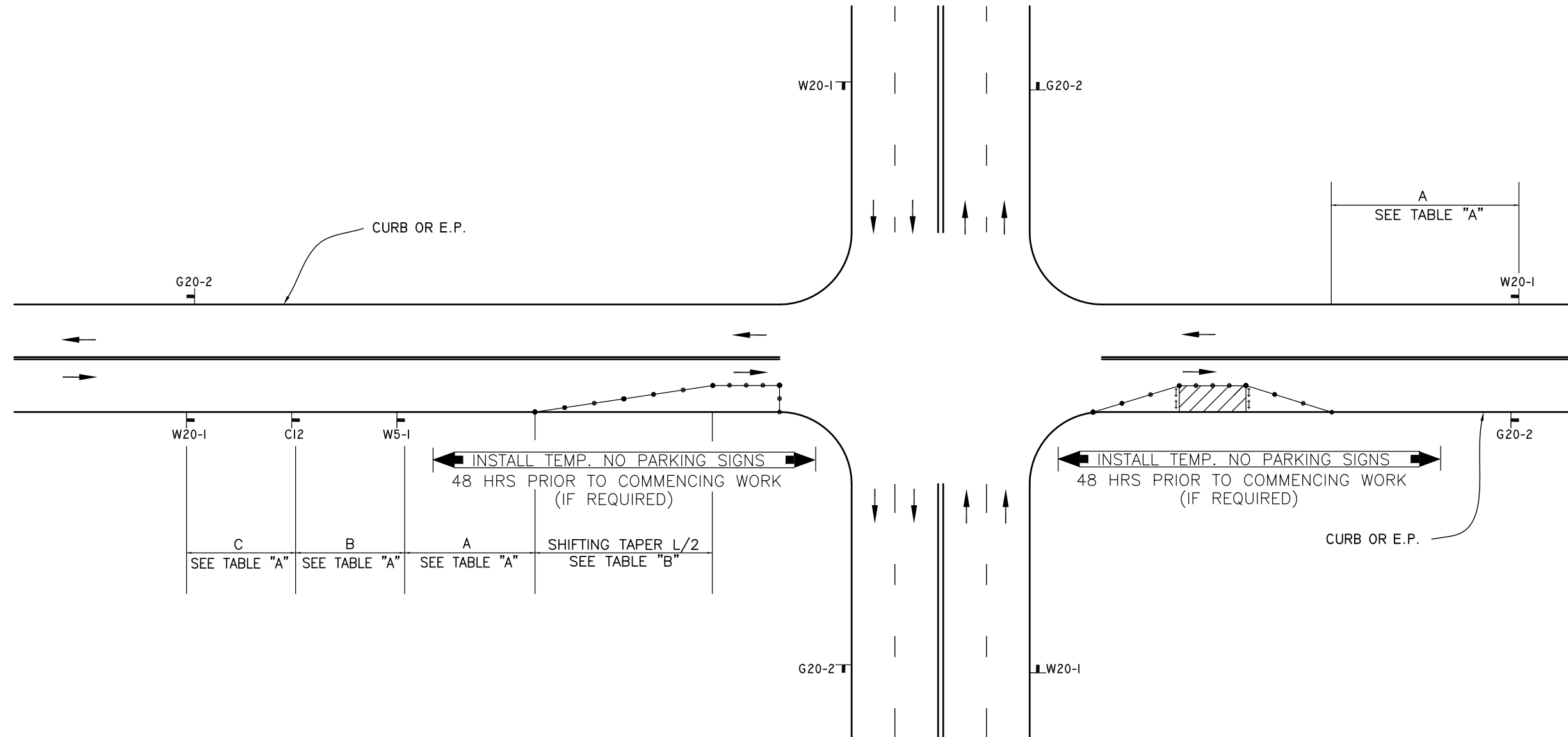

LEGEND

- TYPE III BARRICADE W/SIGN
- TYPE II BARRICADE W/O SIGN
- CHANNELIZING DEVICE
- TRAFFIC CONE WITH CLIP ON SIGN
- SIGN
- SIGNALIZED INTERSECTION
- ARROW PANEL (FLASHING ARROW) (WHERE REQUIRED)
- HIGH LEVEL WARNING DEVICE (FLAGTREE) (OPTIONAL)
- FLAGGER
- TANS TOW AWAY NO STOPPING ____ TO ____ (SHOW HOURS)
- TANSAT TOW AWAY NO STOPPING ANY TIME
- WORK ZONE (ACTIVITY AREA) LIMITS
- DIRECTION OF TRAFFIC (NOT PAVEMENT MARKING)
- ROADWAY DESIGNATION (A THROUGH D)

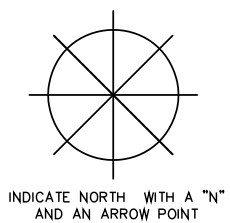
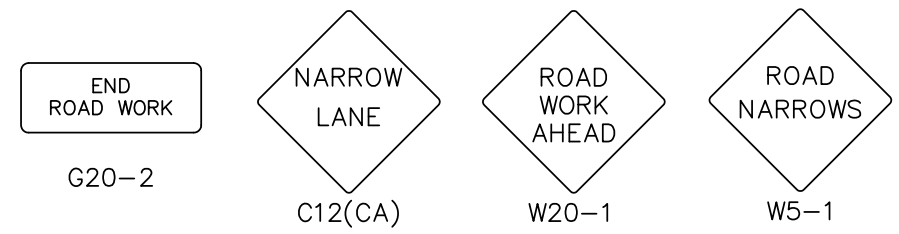

DATES OF TEMPORARY NO PARKING ZONE		
WORKSITE TRAFFIC CONTROL PLAN WORK BEYOND INTERSECTION RIGHT SIDE SINGLE THRU LANE		
DATE		SCALE
		NONE
		DRAWING NO. 25



CONSTRUCTION NOTE:
 ALL DRIVEWAYS TO REMAIN OPEN (WHENEVER POSSIBLE) THROUGHOUT TRAFFIC CONTROL ZONE

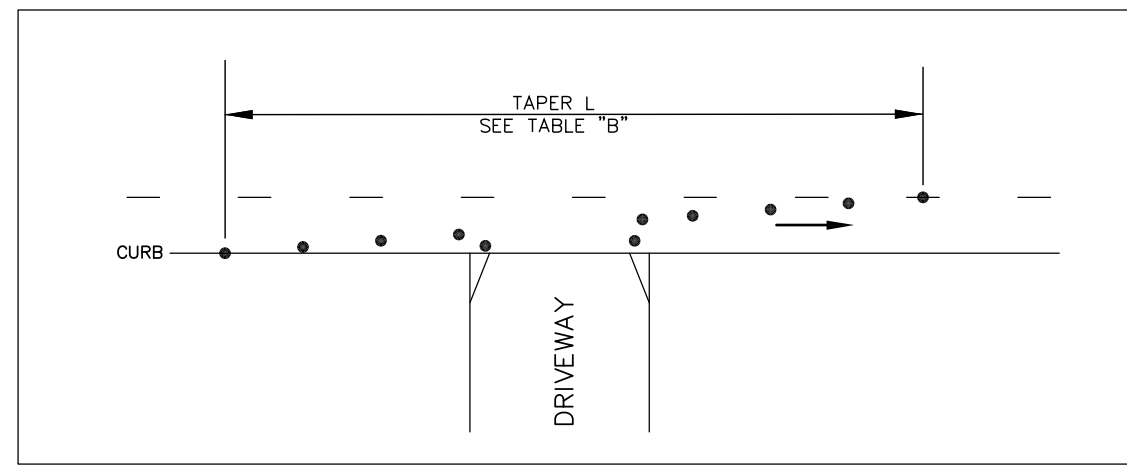

SEE TABLE 'A'-'F' FOR SIGN AND CHANNELIZER DEVICE SPACING AND TAPER LENGTH

SPEED	APPROACH STREET	TAPER LENGTH	SIGN SPACING	CHANNELIZER SPACING

SEE TABLE 'A'-'F' FOR SIGN AND CHANNELIZER DEVICE SPACING AND TAPER LENGTH

SPEED	APPROACH STREET	TAPER LENGTH	SIGN SPACING	CHANNELIZER SPACING

ABBREVIATIONS:

- S = Sign Spacing
- Min = Minimum
- LT = Left
- RT = Right
- LTP = Lane Traffic Panel
- TANSAT = Tow Away, No Stopping Anytime
- TANS = Tow Away, No Stopping

— CHART A —
 MINIMUM RECOMMENDED DELINEATOR/CONE & SIGN PLACEMENT

POSTED SPEED LIMIT	TAPER LENGTH FOR 12-FT LANE			CHANNELIZER SPACING		SIGN SPACING (ADVANCE OF TAPER & BETWEEN SIGNS)
	MERGING	SHIFTING	SHOULDER	TAPER	TANGENT	
20 MPH	80 FT.	40 FT.	27 FT.	20 FT.	40 FT.	100 FT.
25 MPH	125 FT.	63 FT.	42 FT.	25 FT.	63 FT.	100 FT.
30 MPH	180 FT.	90 FT.	60 FT.	30 FT.	90 FT.	350 FT.
35 MPH	245 FT.	123 FT.	82 FT.	35 FT.	123 FT.	350 FT.
40 MPH	320 FT.	160 FT.	107 FT.	40 FT.	160 FT.	350 FT.
* 45 MPH	540 FT.	270 FT.	180 FT.	45 FT.	270 FT.	500 FT.
* 50 MPH	600 FT.	300 FT.	200 FT.	50 FT.	300 FT.	500 FT.
* 55+MPH	660 FT.	330 FT.	220 FT.	55 FT.	330 FT.	PER TABLE 'A'

NOTES

1. A Flashing Arrow sign shall be used for each lane closed.
- *2. Two lane closure signs (C-20) shall be used on the approach to a lane closure with speeds of 45 mph or greater.

NOTE: This chart based on 12-foot wide lanes.

For lane widths greater than 12 feet, use the following formulae:

Taper formula:

$$L = S \times W \text{ for speeds of 45 mph or more.}$$

$$L = \frac{WS^2}{60} \text{ for speeds of 40 mph or less.}$$

Where:

L = Minimum length of taper.

S = Numerical value of posted speed limit prior to work or 85 percentile speed.

W = Width of offset.

i.e.: 50 mph and 19' lane; $L = 50 \times 19 = 950$ feet

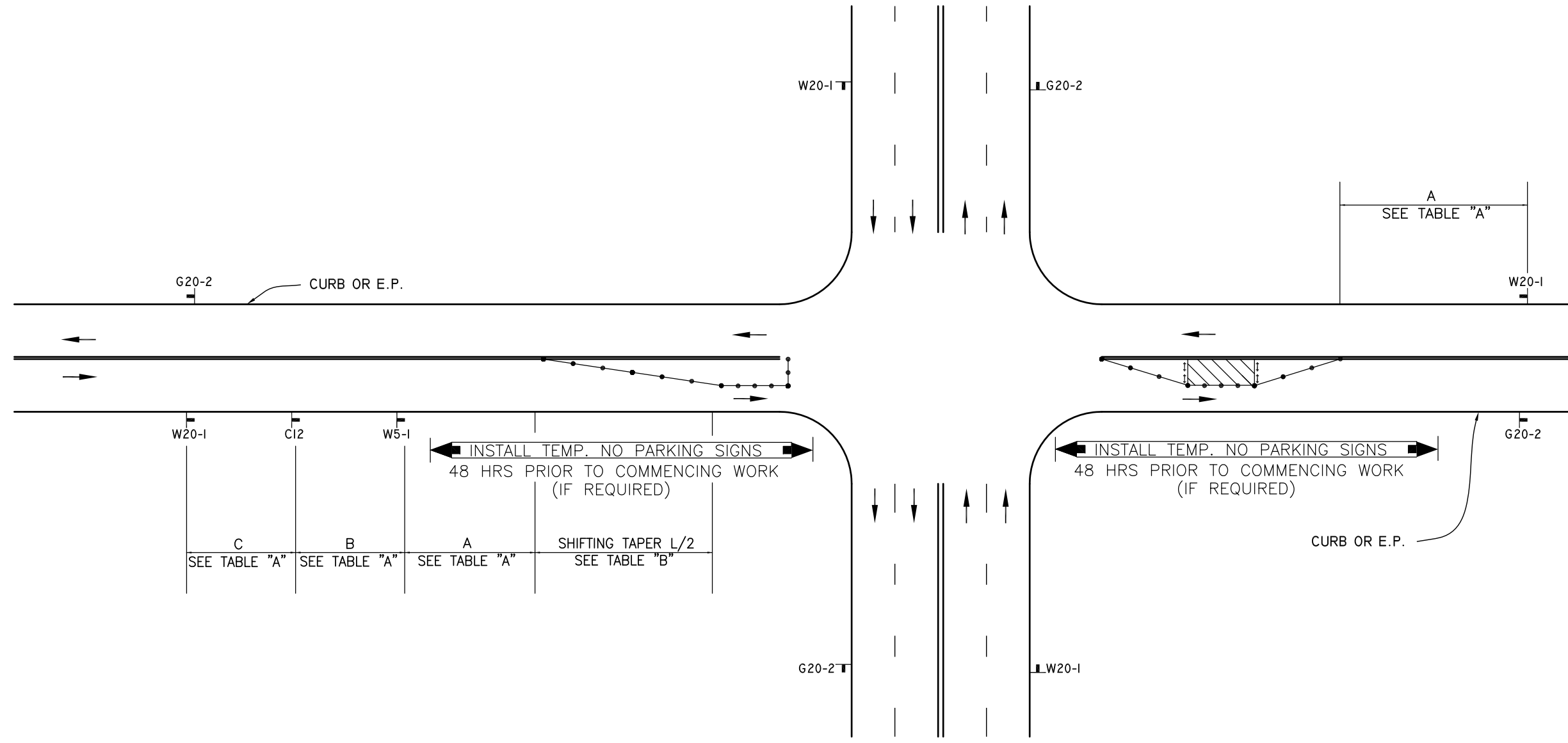

LEGEND

- TYPE III BARRICADE W/SIGN
- TYPE II BARRICADE W/O SIGN
- CHANNELIZING DEVICE
- TRAFFIC CONE WITH CLIP ON SIGN
- SIGN
- SIGNALIZED INTERSECTION
- ARROW PANEL (FLASHING ARROW) (WHERE REQUIRED)
- HIGH LEVEL WARNING DEVICE (FLAGTREE) (OPTIONAL)
- FLAGGER
- TANS TOW AWAY NO STOPPING ____ TO ____ (SHOW HOURS)
- TANSAT TOW AWAY NO STOPPING ANY TIME
- WORK ZONE (ACTIVITY AREA) LIMITS
- DIRECTION OF TRAFFIC (NOT PAVEMENT MARKING)
- ROADWAY DESIGNATION (A THROUGH D)

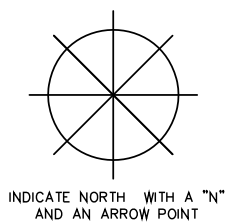
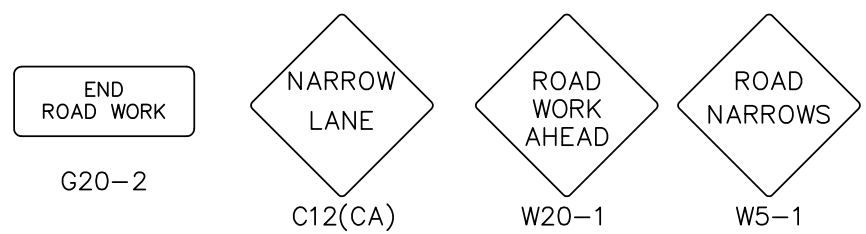

DATES OF TEMPORARY NO PARKING ZONE		
WORKSITE TRAFFIC CONTROL PLAN WORK BEYOND INTERSECTION LEFT SIDE SINGLE THRU LANE		
DATE		SCALE
		NONE
		DRAWING NO. 26

REV. APR-2010 C:\JTCM-DWG26.DWG



CONSTRUCTION NOTE:
 ALL DRIVEWAYS TO REMAIN OPEN (WHENEVER POSSIBLE) THROUGHOUT TRAFFIC CONTROL ZONE



SEE TABLE 'A'-'F' FOR SIGN AND CHANNELIZER DEVICE SPACING AND TAPER LENGTH

SPEED	APPROACH STREET	TAPER LENGTH	SIGN SPACING	CHANNELIZER SPACING

SEE TABLE 'A'-'F' FOR SIGN AND CHANNELIZER DEVICE SPACING AND TAPER LENGTH

SPEED	APPROACH STREET	TAPER LENGTH	SIGN SPACING	CHANNELIZER SPACING

ABBREVIATIONS:

- S = Sign Spacing
- Min = Minimum
- LT = Left
- RT = Right
- LTP = Lane Traffic Panel
- TANSAT = Tow Away, No Stopping Anytime
- TANS = Tow Away, No Stopping

— CHART A —
 MINIMUM RECOMMENDED DELINEATOR/CONE & SIGN PLACEMENT

POSTED SPEED LIMIT	TAPER LENGTH FOR 12-FT LANE			CHANNELIZER SPACING		SIGN SPACING (ADVANCE OF TAPER & BETWEEN SIGNS)
	MERGING	SHIFTING	SHOULDER	TAPER	TANGENT	
20 MPH	80 FT.	40 FT.	27 FT.	20 FT.	40 FT.	100 FT.
25 MPH	125 FT.	63 FT.	42 FT.	25 FT.	63 FT.	100 FT.
30 MPH	180 FT.	90 FT.	60 FT.	30 FT.	90 FT.	350 FT.
35 MPH	245 FT.	123 FT.	82 FT.	35 FT.	123 FT.	350 FT.
40 MPH	320 FT.	160 FT.	107 FT.	40 FT.	160 FT.	350 FT.
* 45 MPH	540 FT.	270 FT.	180 FT.	45 FT.	270 FT.	500 FT.
* 50 MPH	600 FT.	300 FT.	200 FT.	50 FT.	300 FT.	500 FT.
* 55+MPH	660 FT.	330 FT.	220 FT.	55 FT.	330 FT.	PER TABLE 'A'

NOTES

1. A Flashing Arrow sign shall be used for each lane closed.
- *2. Two lane closure signs (C-20) shall be used on the approach to a lane closure with speeds of 45 mph or greater.

NOTE: This chart based on 12-foot wide lanes.

For lane widths greater than 12 feet, use the following formulae:

Taper formula:

$$L = S \times W \text{ for speeds of 45 mph or more.}$$

$$L = \frac{WS^2}{60} \text{ for speeds of 40 mph or less.}$$

Where:

L = Minimum length of taper.

S = Numerical value of posted speed limit prior to work or 85 percentile speed.

W = Width of offset.

i.e.: 50 mph and 19' lane; $L = 50 \times 19 = 950$ feet

REV. APR-2010 C:\JUTCM-DWG27.DWG

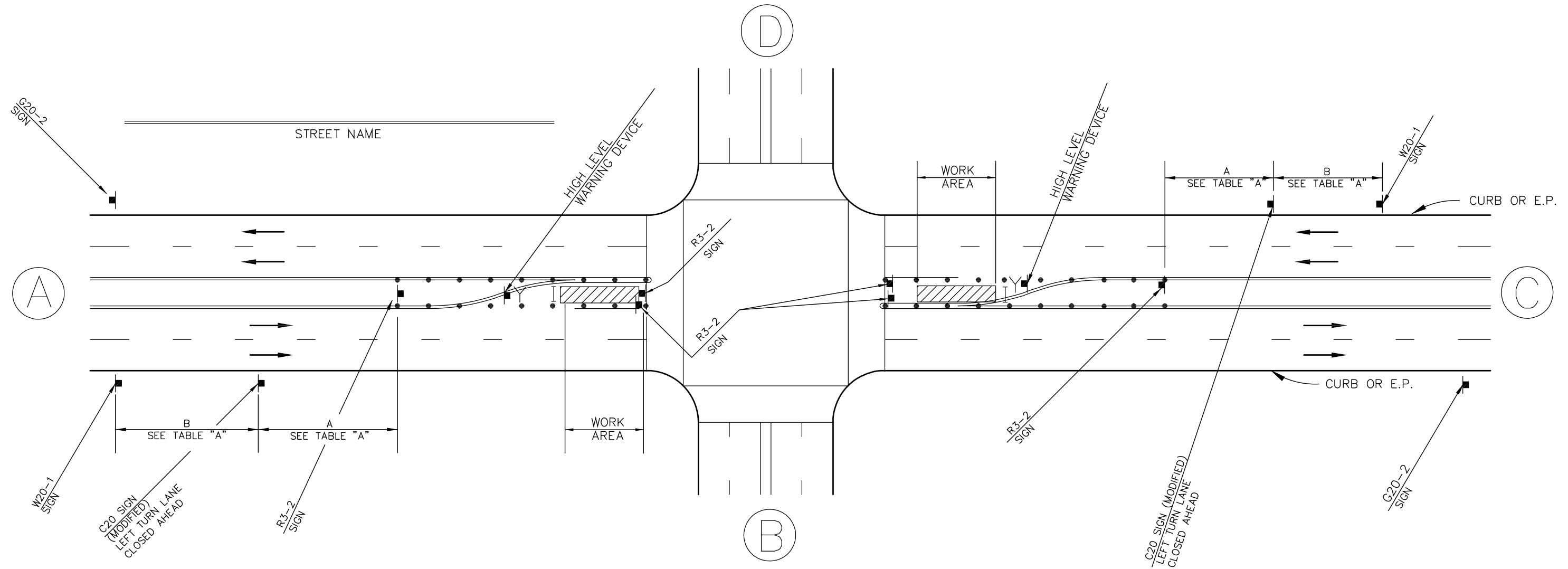

LEGEND

- TYPE III BARRICADE W/SIGN
- TYPE II BARRICADE W/O SIGN
- 28"(11cm) TRAFFIC CONES W/13"(5cm) REFLECTIVE SLEEVE FOR DAY/NIGHT USE OR DELINEATORS IF DAY USE ONLY
- TRAFFIC CONE WITH CLIP ON SIGN
- PROPOSED SIGN AND POST
- EXISTING SIGN AND POST
- SIGNALIZED INTERSECTION
- FLASHING ARROW SIGN
- HIGH LEVEL WARNING DEVICE WITH SIGN
- FLAGGER
- TANS TOW AWAY NO STOPPING ____ TO ____ (SHOW HOURS)
- TANSAT TOW AWAY NO STOPPING ANY TIME
- WORK ZONE LIMITS
- DIRECTION OF TRAFFIC
- ROADWAY DESIGNATION (A THROUGH D)

END ROAD WORK
G20-2



W20-1

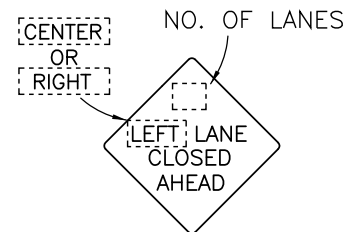

C20(CA)
INTERCHANGEABLE WITH W20-5

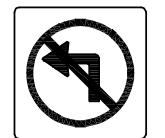

R3-2



C30(CA)

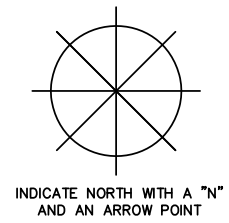

DATES OF TEMPORARY NO PARKING ZONE		
WORKSITE TRAFFIC CONTROL PLAN LEFT TURN LANE CLOSURE		
DATE		SCALE
		NONE
		DRAWING NO.
		27



CONSTRUCTION NOTE:
ALL DRIVEWAYS TO REMAIN OPEN (WHENEVER POSSIBLE) THROUGHOUT TRAFFIC CONTROL ZONE



SEE TABLE 'A'-'F' FOR SIGN AND CHANNELIZER DEVICE SPACING AND TAPER LENGTH

SPEED	APPROACH STREET	TAPER LENGTH	SIGN SPACING	CHANNELIZER SPACING

SEE TABLE 'A'-'F' FOR SIGN AND CHANNELIZER DEVICE SPACING AND TAPER LENGTH

SPEED	APPROACH STREET	TAPER LENGTH	SIGN SPACING	CHANNELIZER SPACING

ABBREVIATIONS:

- S = Sign Spacing
- Min = Minimum
- LT = Left
- RT = Right
- LTP = Lane Traffic Panel
- TANSAT = Tow Away, No Stopping Anytime
- TANS = Tow Away, No Stopping

— CHART A —
MINIMUM RECOMMENDED DELINEATOR/CONE & SIGN PLACEMENT

POSTED SPEED LIMIT	TAPER LENGTH FOR 12-FT LANE			CHANNELIZER SPACING		SIGN SPACING (ADVANCE OF TAPER & BETWEEN SIGNS)
	MERGING	SHIFTING	SHOULDER	TAPER	TANGENT	
20 MPH	80 FT.	40 FT.	27 FT.	20 FT.	40 FT.	100 FT.
25 MPH	125 FT.	63 FT.	42 FT.	25 FT.	63 FT.	100 FT.
30 MPH	180 FT.	90 FT.	60 FT.	30 FT.	90 FT.	350 FT.
35 MPH	245 FT.	123 FT.	82 FT.	35 FT.	123 FT.	350 FT.
40 MPH	320 FT.	160 FT.	107 FT.	40 FT.	160 FT.	350 FT.
* 45 MPH	540 FT.	270 FT.	180 FT.	45 FT.	270 FT.	500 FT.
* 50 MPH	600 FT.	300 FT.	200 FT.	50 FT.	300 FT.	500 FT.
* 55+MPH	660 FT.	330 FT.	220 FT.	55 FT.	330 FT.	PER TABLE 'A'

NOTES

1. A Flashing Arrow sign shall be used for each lane closed.
- *2. Two lane closure signs (C-20) shall be used on the approach to a lane closure with speeds of 45 mph or greater.

NOTE: This chart based on 12-foot wide lanes.

For lane widths greater than 12 feet, use the following formulae:

Taper formula:

$$L = S \times W \text{ for speeds of 45 mph or more.}$$

$$L = \frac{WS^2}{60} \text{ for speeds of 40 mph or less.}$$

Where:

L = Minimum length of taper.

S = Numerical value of posted speed limit prior to work or 85 percentile speed.

W = Width of offset.

i.e.: 50 mph and 19' lane; $L = 50 \times 19 = 950$ feet

LEGEND

- TYPE III BARRICADE W/SIGN
- TYPE II BARRICADE W/O SIGN
- CHANNELIZING DEVICE
- TRAFFIC CONE WITH CLIP ON SIGN
- SIGN
- SIGNALIZED INTERSECTION
- ARROW PANEL (FLASHING ARROW) (WHERE REQUIRED)
- HIGH LEVEL WARNING DEVICE (FLAGTREE) (OPTIONAL)
- FLAGGER
- TANS TOW AWAY NO STOPPING ____ TO ____ (SHOW HOURS)
- TANSAT TOW AWAY NO STOPPING ANY TIME
- WORK ZONE (ACTIVITY AREA) LIMITS
- DIRECTION OF TRAFFIC (NOT PAVEMENT MARKING)
- ROADWAY DESIGNATION (A THROUGH D)

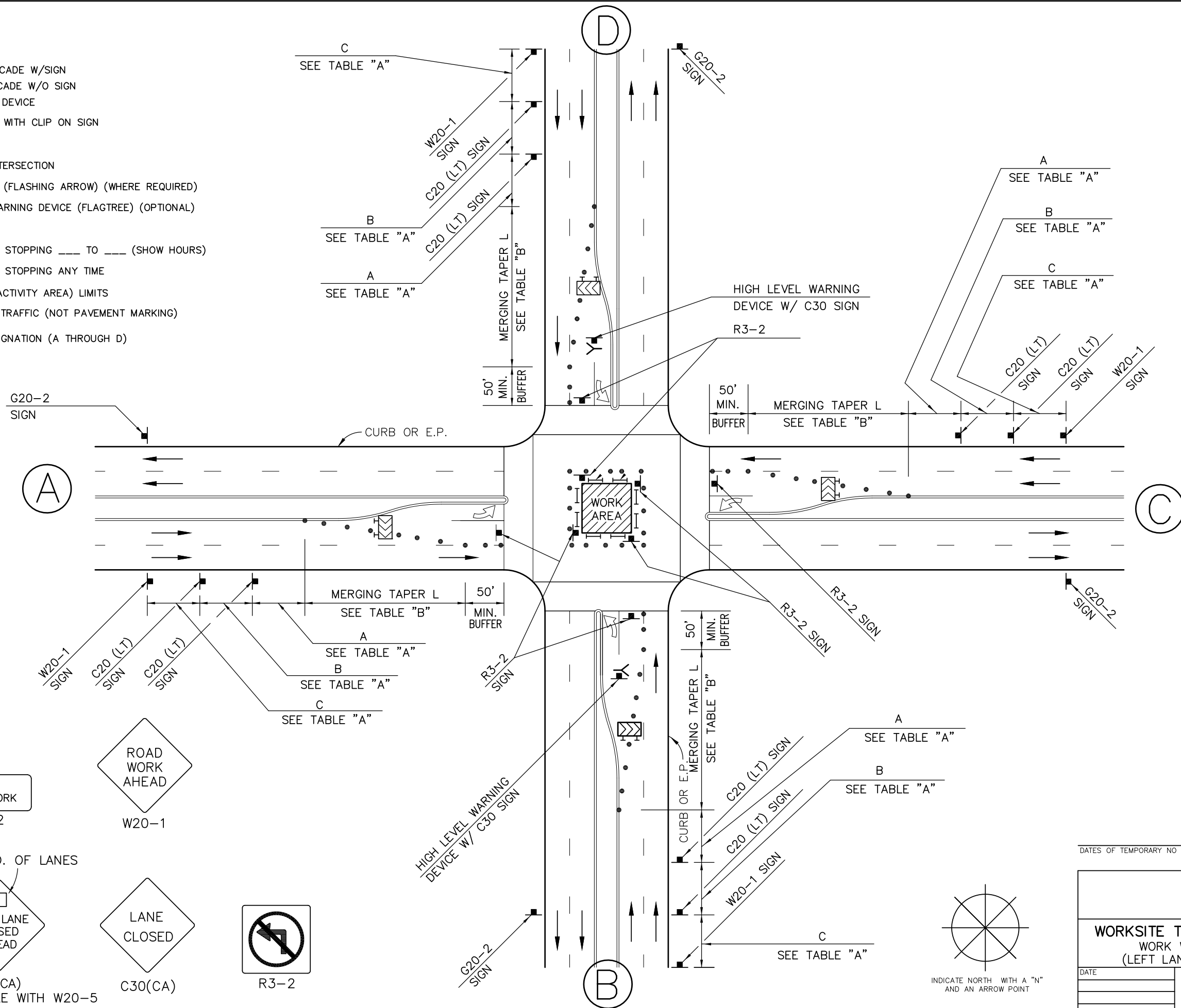

END ROAD WORK
G20-2

ROAD WORK AHEAD
W20-1

CENTER OR RIGHT
NO. OF LANES
LEFT LANE CLOSED AHEAD

LANE CLOSED
C30(CA)

R3-2

C20(CA)
INTERCHANGEABLE WITH W20-5

DATES OF TEMPORARY NO PARKING ZONE

WORKSITE TRAFFIC CONTROL PLAN
WORK WITHIN INTERSECTION
(LEFT LANE / LEFT TURN LANE)

DATE	SCALE
	NONE
	DRAWING NO. 28

INDICATE NORTH WITH A "N" AND AN ARROW POINT



CONSTRUCTION NOTE:
 ALL DRIVEWAYS TO REMAIN OPEN (WHENEVER POSSIBLE) THROUGHOUT TRAFFIC CONTROL ZONE



SEE TABLE 'A'-'F' FOR SIGN AND CHANNELIZER DEVICE SPACING AND TAPER LENGTH

SPEED	APPROACH STREET	TAPER LENGTH	SIGN SPACING	CHANNELIZER SPACING

SEE TABLE 'A'-'F' FOR SIGN AND CHANNELIZER DEVICE SPACING AND TAPER LENGTH

SPEED	APPROACH STREET	TAPER LENGTH	SIGN SPACING	CHANNELIZER SPACING

ABBREVIATIONS:

- S = Sign Spacing
- Min = Minimum
- LT = Left
- RT = Right
- LTP = Lane Traffic Panel
- TANSAT = Tow Away, No Stopping Anytime
- TANS = Tow Away, No Stopping

— CHART A —
 MINIMUM RECOMMENDED DELINEATOR/CONE & SIGN PLACEMENT

POSTED SPEED LIMIT	TAPER LENGTH FOR 12-FT LANE			CHANNELIZER SPACING		SIGN SPACING (ADVANCE OF TAPER & BETWEEN SIGNS)
	MERGING	SHIFTING	SHOULDER	TAPER	TANGENT	
20 MPH	80 FT.	40 FT.	27 FT.	20 FT.	40 FT.	100 FT.
25 MPH	125 FT.	63 FT.	42 FT.	25 FT.	63 FT.	100 FT.
30 MPH	180 FT.	90 FT.	60 FT.	30 FT.	90 FT.	350 FT.
35 MPH	245 FT.	123 FT.	82 FT.	35 FT.	123 FT.	350 FT.
40 MPH	320 FT.	160 FT.	107 FT.	40 FT.	160 FT.	350 FT.
* 45 MPH	540 FT.	270 FT.	180 FT.	45 FT.	270 FT.	500 FT.
* 50 MPH	600 FT.	300 FT.	200 FT.	50 FT.	300 FT.	500 FT.
* 55+MPH	660 FT.	330 FT.	220 FT.	55 FT.	330 FT.	PER TABLE 'A'

NOTES

1. A Flashing Arrow sign shall be used for each lane closed.
- *2. Two lane closure signs (C-20) shall be used on the approach to a lane closure with speeds of 45 mph or greater.

NOTE: This chart based on 12-foot wide lanes.

For lane widths greater than 12 feet, use the following formulae:

Taper formula:

$$L = S \times W \text{ for speeds of 45 mph or more.}$$

$$L = \frac{WS^2}{60} \text{ for speeds of 40 mph or less.}$$

Where:

L = Minimum length of taper.

S = Numerical value of posted speed limit prior to work or 85 percentile speed.

W = Width of offset.

i.e.: 50 mph and 19' lane; $L = 50 \times 19 = 950$ feet

REV. APR-2010 C:\JTCM-DWG29.DWG

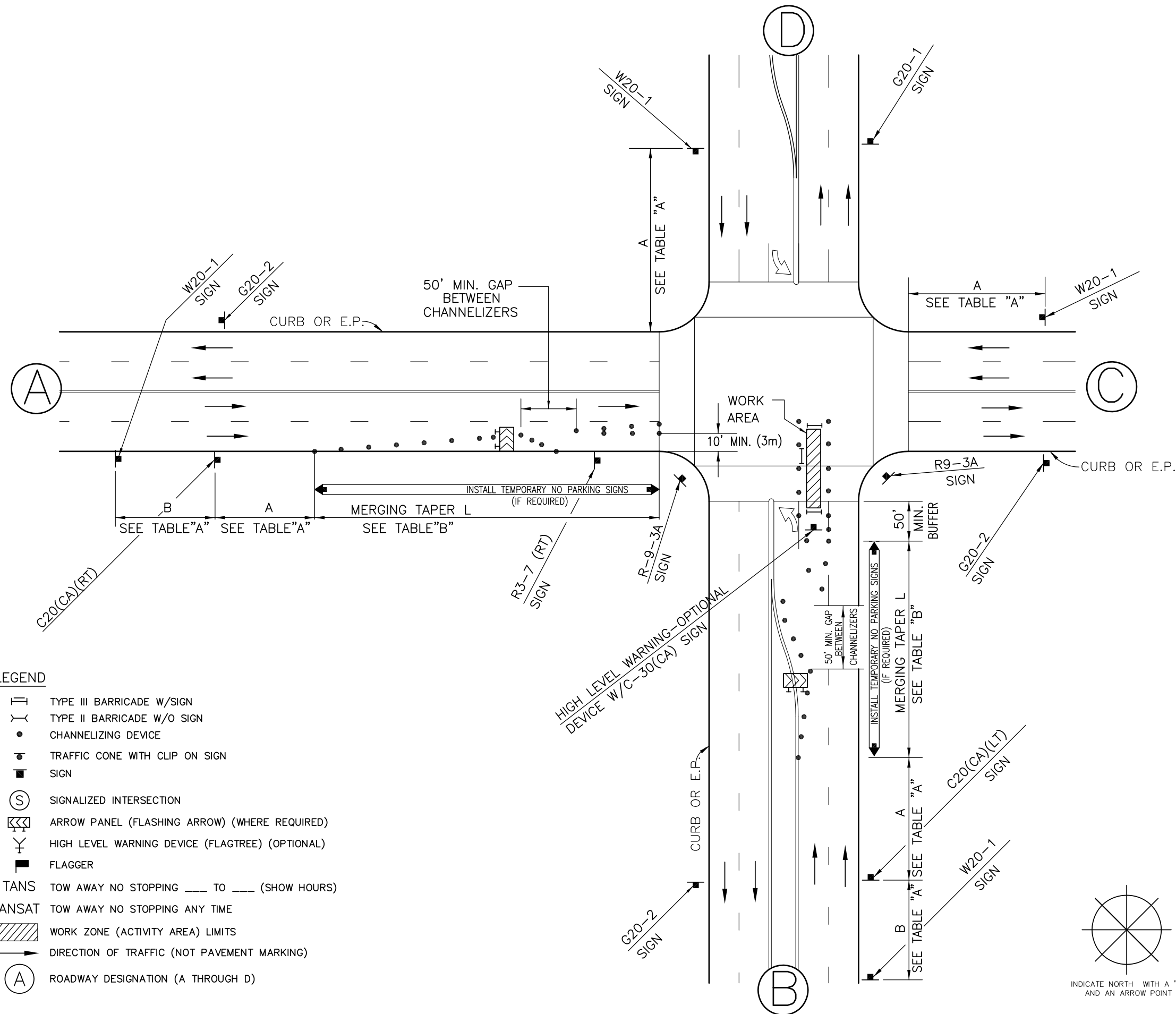

LEGEND

- TYPE III BARRICADE W/SIGN
- TYPE II BARRICADE W/O SIGN
- CHANNELIZING DEVICE
- TRAFFIC CONE WITH CLIP ON SIGN
- SIGN
- SIGNALIZED INTERSECTION
- ARROW PANEL (FLASHING ARROW) (WHERE REQUIRED)
- HIGH LEVEL WARNING DEVICE (FLAGTREE) (OPTIONAL)
- FLAGGER
- TANS TOW AWAY NO STOPPING ____ TO ____ (SHOW HOURS)
- TANSAT TOW AWAY NO STOPPING ANY TIME
- WORK ZONE (ACTIVITY AREA) LIMITS
- DIRECTION OF TRAFFIC (NOT PAVEMENT MARKING)
- ROADWAY DESIGNATION (A THROUGH D)

- NO. OF LANES
[CENTER OR RIGHT] [LEFT] LANE CLOSED AHEAD
C20(CA)
INTERCHANGEABLE WITH W20-5
- LANE CLOSED
C30(CA)
- ROAD WORK AHEAD
W20-1
- END ROAD WORK
G20-2

DATES OF TEMPORARY NO PARKING ZONE _____

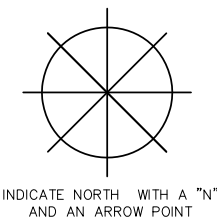

WORKSITE TRAFFIC CONTROL PLAN		
WORK WITHIN INTERSECTION (RIGHT LANE / LEFT LANE)		
DATE		SCALE
		NONE
		DRAWING NO. 29



PLACEMENT OF BIKE LANE CLOSURE SIGN
(IF NECESSARY)

CONSTRUCTION NOTE:
ALL DRIVEWAYS TO REMAIN OPEN (WHENEVER POSSIBLE) THROUGHOUT TRAFFIC CONTROL ZONE

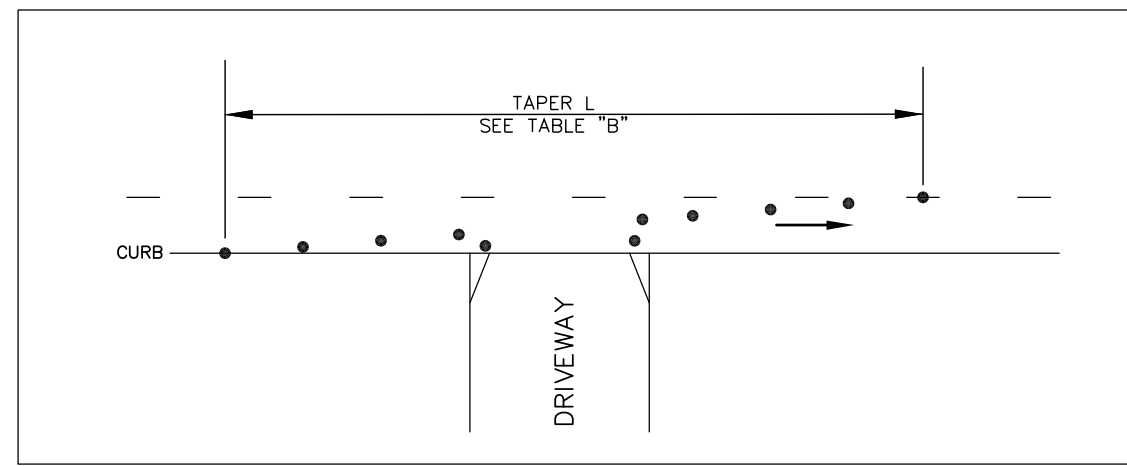

SEE TABLE 'A'-'F' FOR SIGN AND CHANNELIZER DEVICE SPACING AND TAPER LENGTH

SPEED	APPROACH STREET	TAPER LENGTH	SIGN SPACING	CHANNELIZER SPACING

SEE TABLE 'A'-'F' FOR SIGN AND CHANNELIZER DEVICE SPACING AND TAPER LENGTH

SPEED	APPROACH STREET	TAPER LENGTH	SIGN SPACING	CHANNELIZER SPACING

ABBREVIATIONS:

- S = Sign Spacing
- Min = Minimum
- LT = Left
- RT = Right
- LTP = Lane Traffic Panel
- TANSAT = Tow Away, No Stopping Anytime
- TANS = Tow Away, No Stopping

— CHART A —
MINIMUM RECOMMENDED DELINEATOR/CONE & SIGN PLACEMENT

POSTED SPEED LIMIT	TAPER LENGTH FOR 12-FT LANE			CHANNELIZER SPACING		SIGN SPACING (ADVANCE OF TAPER & BETWEEN SIGNS)
	MERGING	SHIFTING	SHOULDER	TAPER	TANGENT	
20 MPH	80 FT.	40 FT.	27 FT.	20 FT.	40 FT.	100 FT.
25 MPH	125 FT.	63 FT.	42 FT.	25 FT.	63 FT.	100 FT.
30 MPH	180 FT.	90 FT.	60 FT.	30 FT.	90 FT.	350 FT.
35 MPH	245 FT.	123 FT.	82 FT.	35 FT.	123 FT.	350 FT.
40 MPH	320 FT.	160 FT.	107 FT.	40 FT.	160 FT.	350 FT.
* 45 MPH	540 FT.	270 FT.	180 FT.	45 FT.	270 FT.	500 FT.
* 50 MPH	600 FT.	300 FT.	200 FT.	50 FT.	300 FT.	500 FT.
* 55+MPH	660 FT.	330 FT.	220 FT.	55 FT.	330 FT.	PER TABLE 'A'

NOTES

1. A Flashing Arrow sign shall be used for each lane closed.
- *2. Two lane closure signs (C-20) shall be used on the approach to a lane closure with speeds of 45 mph or greater.

NOTE: This chart based on 12-foot wide lanes.

For lane widths greater than 12 feet, use the following formulae:

Taper formula:

$$L = S \times W \text{ for speeds of 45 mph or more.}$$

$$L = \frac{WS^2}{60} \text{ for speeds of 40 mph or less.}$$

Where:

L = Minimum length of taper.

S = Numerical value of posted speed limit prior to work or 85 percentile speed.

W = Width of offset.

i.e.: 50 mph and 19' lane; $L = 50 \times 19 = 950$ feet

REV. APR-2010 C:\JUTCM-DWG30.DWG

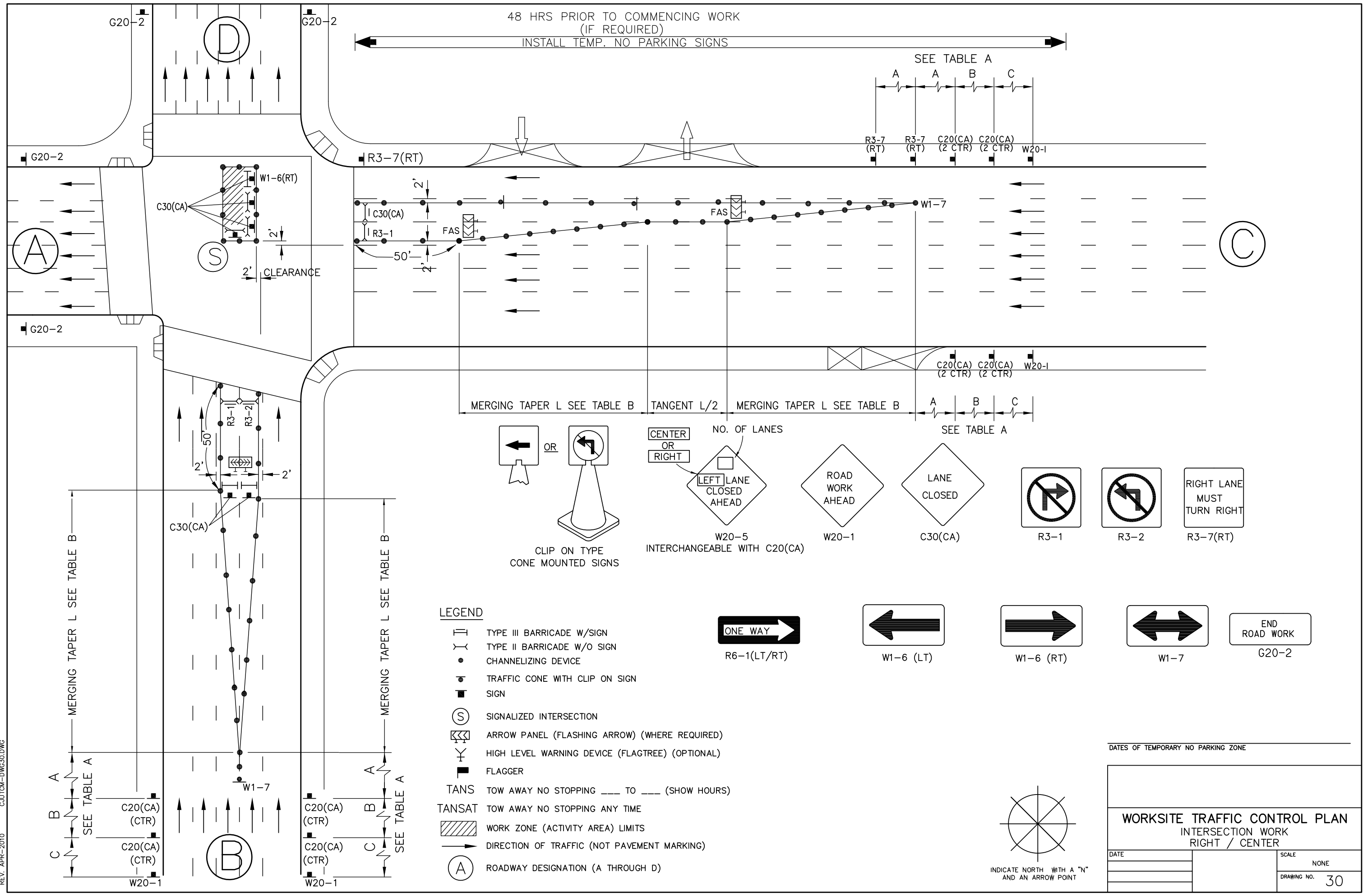



CONSTRUCTION NOTE:
ALL DRIVEWAYS TO REMAIN OPEN (WHENEVER POSSIBLE) THROUGHOUT TRAFFIC CONTROL ZONE



SEE TABLE 'A'-'F' FOR SIGN AND CHANNELIZER DEVICE SPACING AND TAPER LENGTH

SPEED	APPROACH STREET	TAPER LENGTH	SIGN SPACING	CHANNELIZER SPACING

SEE TABLE 'A'-'F' FOR SIGN AND CHANNELIZER DEVICE SPACING AND TAPER LENGTH

SPEED	APPROACH STREET	TAPER LENGTH	SIGN SPACING	CHANNELIZER SPACING

ABBREVIATIONS:

- S = Sign Spacing
- Min = Minimum
- LT = Left
- RT = Right
- LTP = Lane Traffic Panel
- TANSAT = Tow Away, No Stopping Anytime
- TANS = Tow Away, No Stopping

— CHART A —
MINIMUM RECOMMENDED DELINEATOR/CONE & SIGN PLACEMENT

POSTED SPEED LIMIT	TAPER LENGTH FOR 12-FT LANE			CHANNELIZER SPACING		SIGN SPACING (ADVANCE OF TAPER & BETWEEN SIGNS)
	MERGING	SHIFTING	SHOULDER	TAPER	TANGENT	
20 MPH	80 FT.	40 FT.	27 FT.	20 FT.	40 FT.	100 FT.
25 MPH	125 FT.	63 FT.	42 FT.	25 FT.	63 FT.	100 FT.
30 MPH	180 FT.	90 FT.	60 FT.	30 FT.	90 FT.	350 FT.
35 MPH	245 FT.	123 FT.	82 FT.	35 FT.	123 FT.	350 FT.
40 MPH	320 FT.	160 FT.	107 FT.	40 FT.	160 FT.	350 FT.
* 45 MPH	540 FT.	270 FT.	180 FT.	45 FT.	270 FT.	500 FT.
* 50 MPH	600 FT.	300 FT.	200 FT.	50 FT.	300 FT.	500 FT.
* 55+MPH	660 FT.	330 FT.	220 FT.	55 FT.	330 FT.	PER TABLE 'A'

NOTES

1. A Flashing Arrow sign shall be used for each lane closed.
- *2. Two lane closure signs (C-20) shall be used on the approach to a lane closure with speeds of 45 mph or greater.

NOTE: This chart based on 12-foot wide lanes.

For lane widths greater than 12 feet, use the following formulae:

Taper formula:

$$L = S \times W \text{ for speeds of 45 mph or more.}$$

$$L = \frac{WS^2}{60} \text{ for speeds of 40 mph or less.}$$

Where:

L = Minimum length of taper.

S = Numerical value of posted speed limit prior to work or 85 percentile speed.

W = Width of offset.

i.e.: 50 mph and 19' lane; $L = 50 \times 19 = 950$ feet

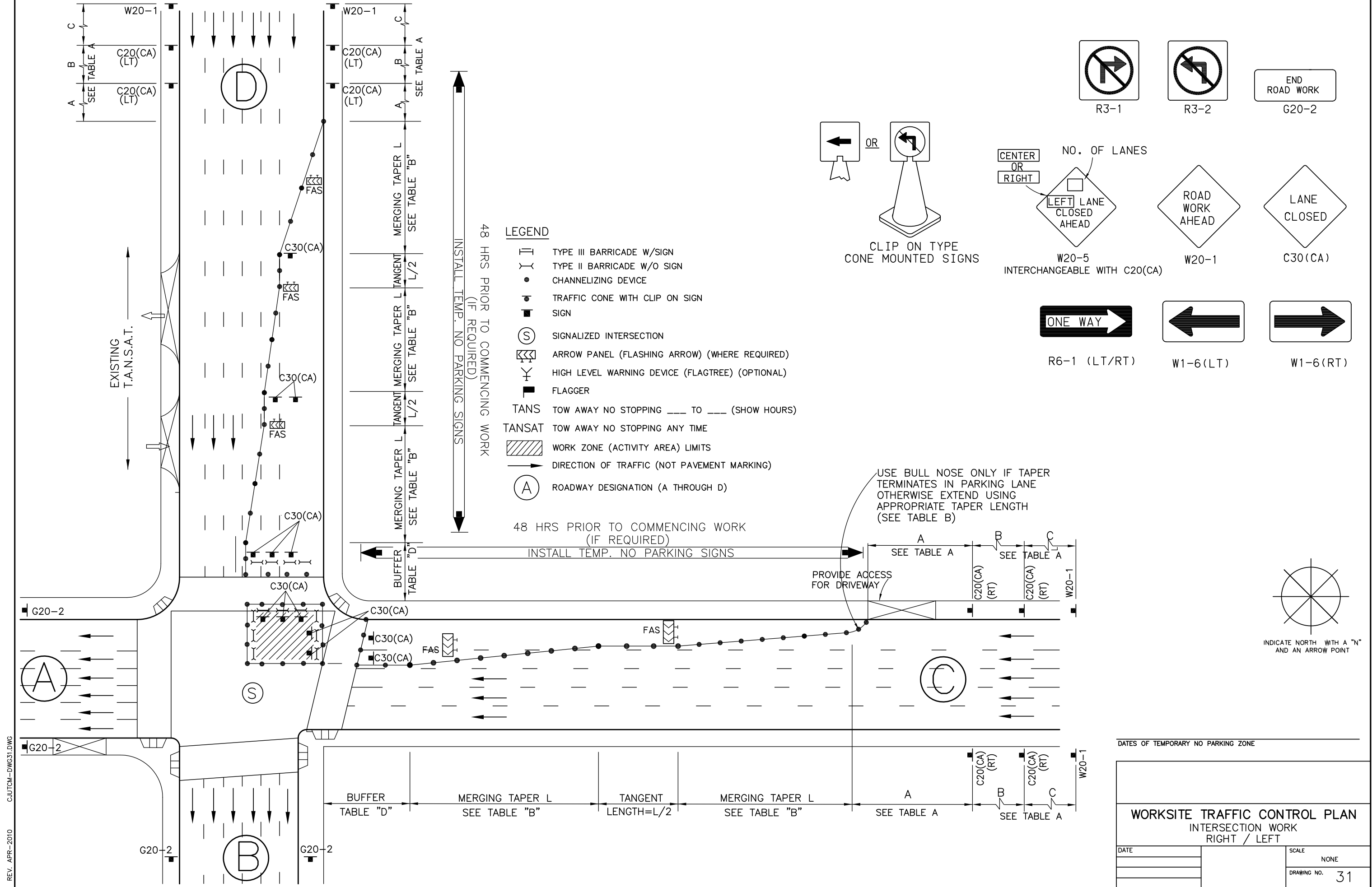

LEGEND

- TYPE III BARRICADE W/SIGN
- TYPE II BARRICADE W/O SIGN
- CHANNELIZING DEVICE
- TRAFFIC CONE WITH CLIP ON SIGN
- SIGN
- SIGNALIZED INTERSECTION
- ARROW PANEL (FLASHING ARROW) (WHERE REQUIRED)
- HIGH LEVEL WARNING DEVICE (FLAGTREE) (OPTIONAL)
- FLAGGER
- TANS TOW AWAY NO STOPPING ____ TO ____ (SHOW HOURS)
- TANSAT TOW AWAY NO STOPPING ANY TIME
- WORK ZONE (ACTIVITY AREA) LIMITS
- DIRECTION OF TRAFFIC (NOT PAVEMENT MARKING)
- ROADWAY DESIGNATION (A THROUGH D)

48 HRS PRIOR TO COMMENCING WORK
(IF REQUIRED)
INSTALL TEMP. NO PARKING SIGNS

48 HRS PRIOR TO COMMENCING WORK
(IF REQUIRED)

CLIP ON TYPE CONE MOUNTED SIGNS

R3-1 R3-2

G20-2

W20-5
INTERCHANGEABLE WITH C20(CA)

W20-1

C30(CA)

R6-1 (LT/RT)

W1-6(LT)

W1-6(RT)

USE BULL NOSE ONLY IF TAPER TERMINATES IN PARKING LANE OTHERWISE EXTEND USING APPROPRIATE TAPER LENGTH (SEE TABLE B)

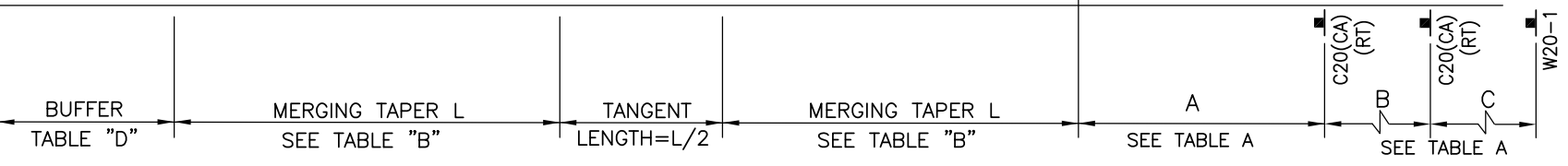
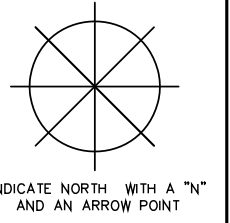

DATES OF TEMPORARY NO PARKING ZONE		
WORKSITE TRAFFIC CONTROL PLAN		
INTERSECTION WORK RIGHT / LEFT		
DATE		SCALE
		NONE
		DRAWING NO. 31

REV. APR-2010 C:\JUTCM-DWG31.DWG



CONSTRUCTION NOTE:
ALL DRIVEWAYS TO REMAIN OPEN (WHENEVER POSSIBLE) THROUGHOUT TRAFFIC CONTROL ZONE



SEE TABLE 'A'-'F' FOR SIGN AND CHANNELIZER DEVICE SPACING AND TAPER LENGTH

SPEED	APPROACH STREET	TAPER LENGTH	SIGN SPACING	CHANNELIZER SPACING

SEE TABLE 'A'-'F' FOR SIGN AND CHANNELIZER DEVICE SPACING AND TAPER LENGTH

SPEED	APPROACH STREET	TAPER LENGTH	SIGN SPACING	CHANNELIZER SPACING

ABBREVIATIONS:

- S = Sign Spacing
- Min = Minimum
- LT = Left
- RT = Right
- LTP = Lane Traffic Panel
- TANSAT = Tow Away, No Stopping Anytime
- TANS = Tow Away, No Stopping

— CHART A —
MINIMUM RECOMMENDED DELINEATOR/CONE & SIGN PLACEMENT

POSTED SPEED LIMIT	TAPER LENGTH FOR 12-FT LANE			CHANNELIZER SPACING		SIGN SPACING (ADVANCE OF TAPER & BETWEEN SIGNS)
	MERGING	SHIFTING	SHOULDER	TAPER	TANGENT	
20 MPH	80 FT.	40 FT.	27 FT.	20 FT.	40 FT.	100 FT.
25 MPH	125 FT.	63 FT.	42 FT.	25 FT.	63 FT.	100 FT.
30 MPH	180 FT.	90 FT.	60 FT.	30 FT.	90 FT.	350 FT.
35 MPH	245 FT.	123 FT.	82 FT.	35 FT.	123 FT.	350 FT.
40 MPH	320 FT.	160 FT.	107 FT.	40 FT.	160 FT.	350 FT.
* 45 MPH	540 FT.	270 FT.	180 FT.	45 FT.	270 FT.	500 FT.
* 50 MPH	600 FT.	300 FT.	200 FT.	50 FT.	300 FT.	500 FT.
* 55+MPH	660 FT.	330 FT.	220 FT.	55 FT.	330 FT.	PER TABLE 'A'

NOTES

1. A Flashing Arrow sign shall be used for each lane closed.
- *2. Two lane closure signs (C-20) shall be used on the approach to a lane closure with speeds of 45 mph or greater.

NOTE: This chart based on 12-foot wide lanes.

For lane widths greater than 12 feet, use the following formulae:

Taper formula:

$$L = S \times W \text{ for speeds of 45 mph or more.}$$

$$L = \frac{WS^2}{60} \text{ for speeds of 40 mph or less.}$$

Where:

L = Minimum length of taper.

S = Numerical value of posted speed limit prior to work or 85 percentile speed.

W = Width of offset.

i.e.: 50 mph and 19' lane; $L = 50 \times 19 = 950$ feet

LEGEND

- TYPE III BARRICADE W/SIGN
- TYPE II BARRICADE W/O SIGN
- CHANNELIZING DEVICE
- TRAFFIC CONE WITH CLIP ON SIGN
- SIGN
- SIGNALIZED INTERSECTION
- ARROW PANEL (FLASHING ARROW) (WHERE REQUIRED)
- HIGH LEVEL WARNING DEVICE (FLAGTREE) (OPTIONAL)
- FLAGGER
- TANS TOW AWAY NO STOPPING ____ TO ____ (SHOW HOURS)
- TANSAT TOW AWAY NO STOPPING ANY TIME
- WORK ZONE (ACTIVITY AREA) LIMITS
- DIRECTION OF TRAFFIC (NOT PAVEMENT MARKING)
- ROADWAY DESIGNATION (A THROUGH D)

48 HRS PRIOR TO COMMENCING WORK
(IF REQUIRED)
INSTALL TEMP. NO PARKING SIGNS

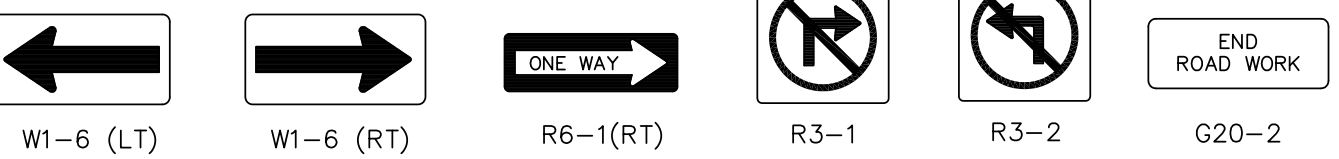
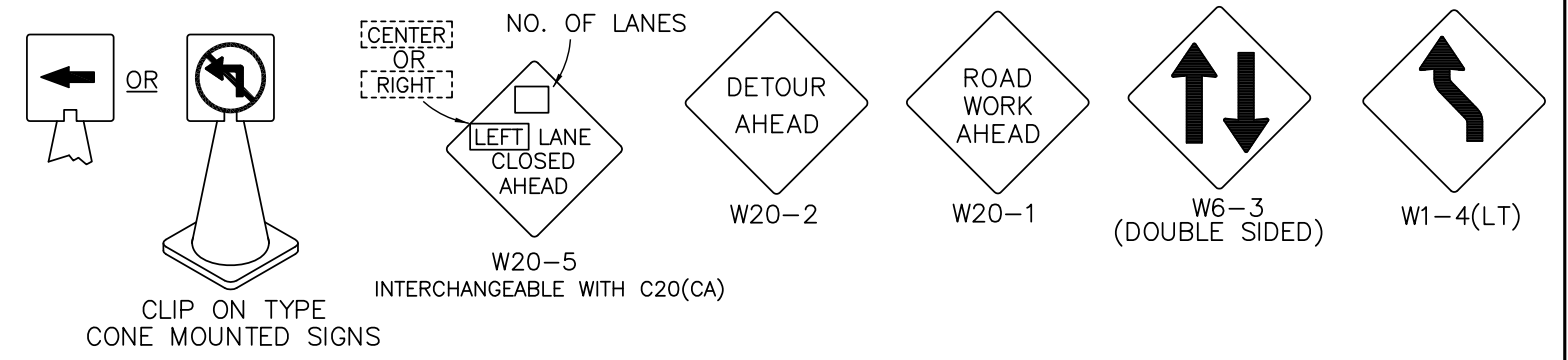

48 HRS PRIOR TO COMMENCING WORK
(IF REQUIRED)
INSTALL TEMP. NO PARKING SIGNS

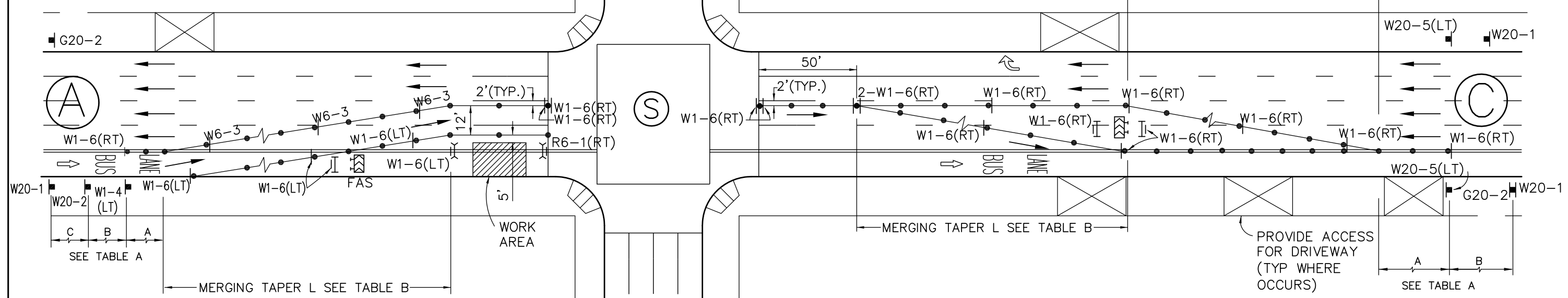

DATES OF TEMPORARY NO PARKING ZONE _____

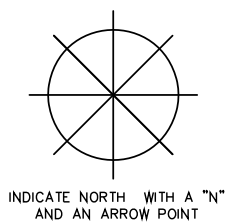

WORKSITE TRAFFIC CONTROL PLAN BEYOND INTERSECTION FAR LEFT		
DATE		SCALE
		NONE
		DRAWING NO.
		32



CONSTRUCTION NOTE:
 ALL DRIVEWAYS TO REMAIN OPEN (WHENEVER POSSIBLE) THROUGHOUT TRAFFIC CONTROL ZONE



SEE TABLE 'A'-'F' FOR SIGN AND CHANNELIZER DEVICE SPACING AND TAPER LENGTH

SPEED	APPROACH STREET	TAPER LENGTH	SIGN SPACING	CHANNELIZER SPACING

SEE TABLE 'A'-'F' FOR SIGN AND CHANNELIZER DEVICE SPACING AND TAPER LENGTH

SPEED	APPROACH STREET	TAPER LENGTH	SIGN SPACING	CHANNELIZER SPACING

ABBREVIATIONS:

- S = Sign Spacing
- Min = Minimum
- LT = Left
- RT = Right
- LTP = Lane Traffic Panel
- TANSAT = Tow Away, No Stopping Anytime
- TANS = Tow Away, No Stopping

— CHART A —
 MINIMUM RECOMMENDED DELINEATOR/CONE & SIGN PLACEMENT

POSTED SPEED LIMIT	TAPER LENGTH FOR 12-FT LANE			CHANNELIZER SPACING		SIGN SPACING (ADVANCE OF TAPER & BETWEEN SIGNS)
	MERGING	SHIFTING	SHOULDER	TAPER	TANGENT	
20 MPH	80 FT.	40 FT.	27 FT.	20 FT.	40 FT.	100 FT.
25 MPH	125 FT.	63 FT.	42 FT.	25 FT.	63 FT.	100 FT.
30 MPH	180 FT.	90 FT.	60 FT.	30 FT.	90 FT.	350 FT.
35 MPH	245 FT.	123 FT.	82 FT.	35 FT.	123 FT.	350 FT.
40 MPH	320 FT.	160 FT.	107 FT.	40 FT.	160 FT.	350 FT.
* 45 MPH	540 FT.	270 FT.	180 FT.	45 FT.	270 FT.	500 FT.
* 50 MPH	600 FT.	300 FT.	200 FT.	50 FT.	300 FT.	500 FT.
* 55+MPH	660 FT.	330 FT.	220 FT.	55 FT.	330 FT.	PER TABLE 'A'

NOTES

1. A Flashing Arrow sign shall be used for each lane closed.
- *2. Two lane closure signs (C-20) shall be used on the approach to a lane closure with speeds of 45 mph or greater.

NOTE: This chart based on 12-foot wide lanes.

For lane widths greater than 12 feet, use the following formulae:

Taper formula:

$$L = S \times W \text{ for speeds of 45 mph or more.}$$

$$L = \frac{WS^2}{60} \text{ for speeds of 40 mph or less.}$$

Where:

L = Minimum length of taper.

S = Numerical value of posted speed limit prior to work or 85 percentile speed.

W = Width of offset.

i.e.: 50 mph and 19' lane; $L = 50 \times 19 = 950$ feet

REV. APR-2010 C:\JUTCM-DWG33.DWG

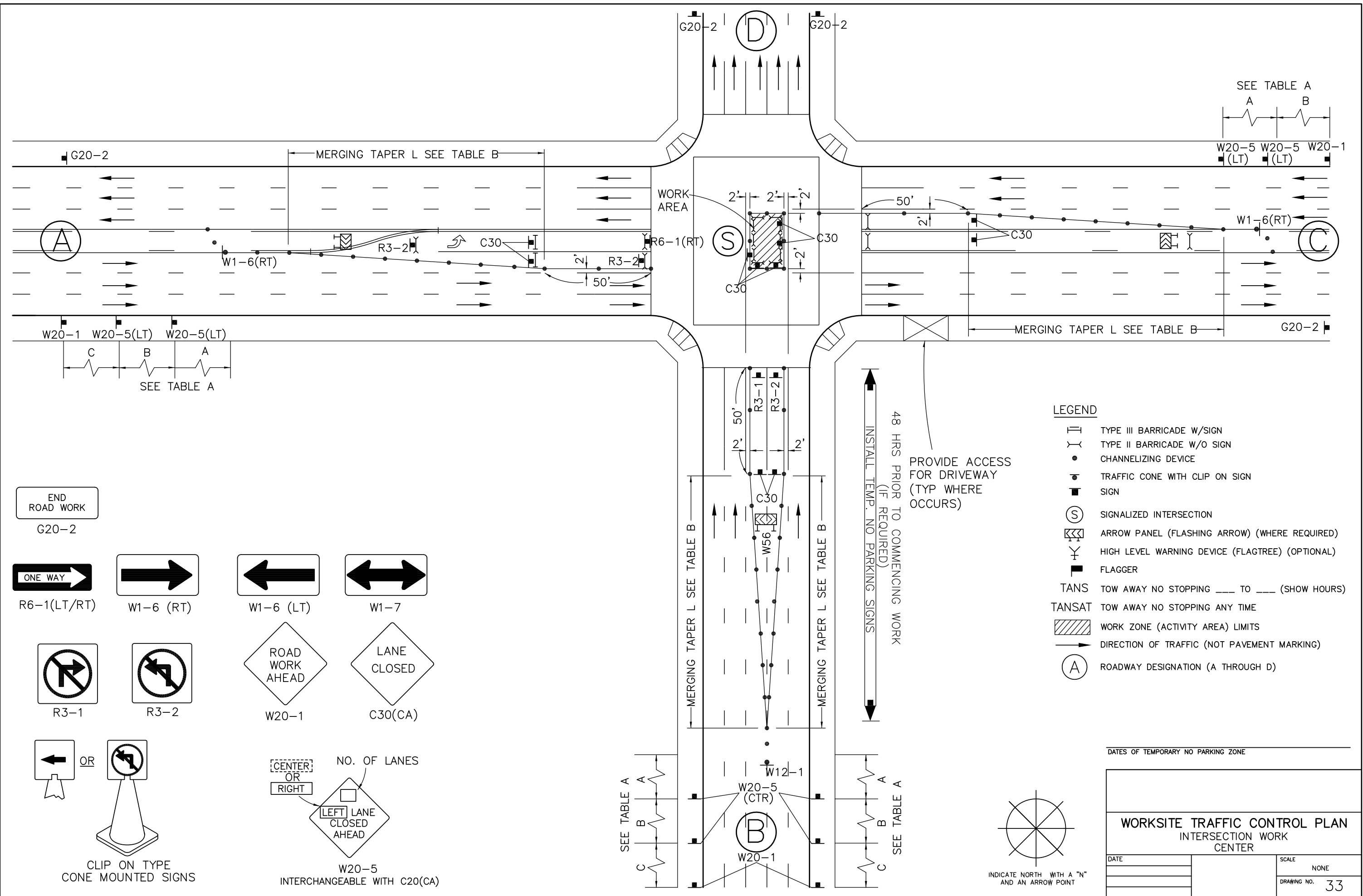

- LEGEND**
- TYPE III BARRICADE W/SIGN
 - TYPE II BARRICADE W/O SIGN
 - CHANNELIZING DEVICE
 - TRAFFIC CONE WITH CLIP ON SIGN
 - SIGN
 - SIGNALIZED INTERSECTION
 - ARROW PANEL (FLASHING ARROW) (WHERE REQUIRED)
 - HIGH LEVEL WARNING DEVICE (FLAGTREE) (OPTIONAL)
 - FLAGGER
 - TANS TOW AWAY NO STOPPING ____ TO ____ (SHOW HOURS)
 - TANSAT TOW AWAY NO STOPPING ANY TIME
 - WORK ZONE (ACTIVITY AREA) LIMITS
 - DIRECTION OF TRAFFIC (NOT PAVEMENT MARKING)
 - ROADWAY DESIGNATION (A THROUGH D)

END ROAD WORK
G20-2

ONE WAY
R6-1(LT/RT) W1-6 (RT) W1-6 (LT) W1-7

R3-1 **R3-2** **ROAD WORK AHEAD** (W20-1) **LANE CLOSED** (C30(CA))

CLIP ON TYPE CONE MOUNTED SIGNS

W20-5 INTERCHANGEABLE WITH C20(CA)

NO. OF LANES
[CENTER OR RIGHT] [LEFT] LANE CLOSED AHEAD

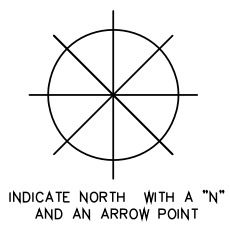

DATES OF TEMPORARY NO PARKING ZONE _____

WORKSITE TRAFFIC CONTROL PLAN INTERSECTION WORK CENTER		
DATE		SCALE NONE
		DRAWING NO. 33



CONSTRUCTION NOTE:
 ALL DRIVEWAYS TO REMAIN OPEN (WHENEVER POSSIBLE) THROUGHOUT TRAFFIC CONTROL ZONE

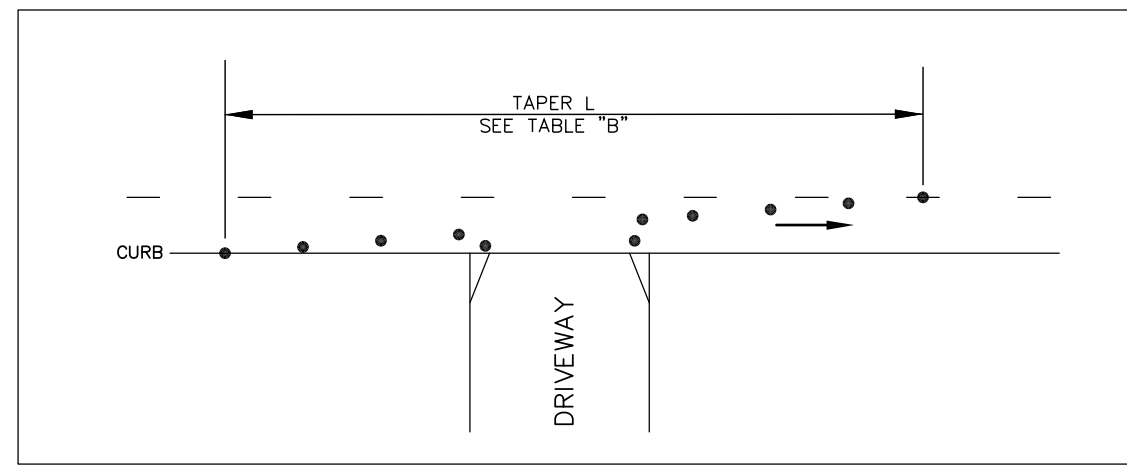

SEE TABLE 'A'-'F' FOR SIGN AND CHANNELIZER DEVICE SPACING AND TAPER LENGTH

SPEED	APPROACH STREET	TAPER LENGTH	SIGN SPACING	CHANNELIZER SPACING

SEE TABLE 'A'-'F' FOR SIGN AND CHANNELIZER DEVICE SPACING AND TAPER LENGTH

SPEED	APPROACH STREET	TAPER LENGTH	SIGN SPACING	CHANNELIZER SPACING

ABBREVIATIONS:

- S = Sign Spacing
- Min = Minimum
- LT = Left
- RT = Right
- LTP = Lane Traffic Panel
- TANSAT = Tow Away, No Stopping Anytime
- TANS = Tow Away, No Stopping

— CHART A —
 MINIMUM RECOMMENDED DELINEATOR/CONE & SIGN PLACEMENT

POSTED SPEED LIMIT	TAPER LENGTH FOR 12-FT LANE			CHANNELIZER SPACING		SIGN SPACING (ADVANCE OF TAPER & BETWEEN SIGNS)
	MERGING	SHIFTING	SHOULDER	TAPER	TANGENT	
20 MPH	80 FT.	40 FT.	27 FT.	20 FT.	40 FT.	100 FT.
25 MPH	125 FT.	63 FT.	42 FT.	25 FT.	63 FT.	100 FT.
30 MPH	180 FT.	90 FT.	60 FT.	30 FT.	90 FT.	350 FT.
35 MPH	245 FT.	123 FT.	82 FT.	35 FT.	123 FT.	350 FT.
40 MPH	320 FT.	160 FT.	107 FT.	40 FT.	160 FT.	350 FT.
* 45 MPH	540 FT.	270 FT.	180 FT.	45 FT.	270 FT.	500 FT.
* 50 MPH	600 FT.	300 FT.	200 FT.	50 FT.	300 FT.	500 FT.
* 55+MPH	660 FT.	330 FT.	220 FT.	55 FT.	330 FT.	PER TABLE 'A'

NOTES

1. A Flashing Arrow sign shall be used for each lane closed.
- *2. Two lane closure signs (C-20) shall be used on the approach to a lane closure with speeds of 45 mph or greater.

NOTE: This chart based on 12-foot wide lanes.

For lane widths greater than 12 feet, use the following formulae:

Taper formula:

$$L = S \times W \text{ for speeds of 45 mph or more.}$$

$$L = \frac{WS^2}{60} \text{ for speeds of 40 mph or less.}$$

Where:

L = Minimum length of taper.

S = Numerical value of posted speed limit prior to work or 85 percentile speed.

W = Width of offset.

i.e.: 50 mph and 19' lane; $L = 50 \times 19 = 950$ feet

REV. APR-2010 C:\JUTCM-DWG34.DWG

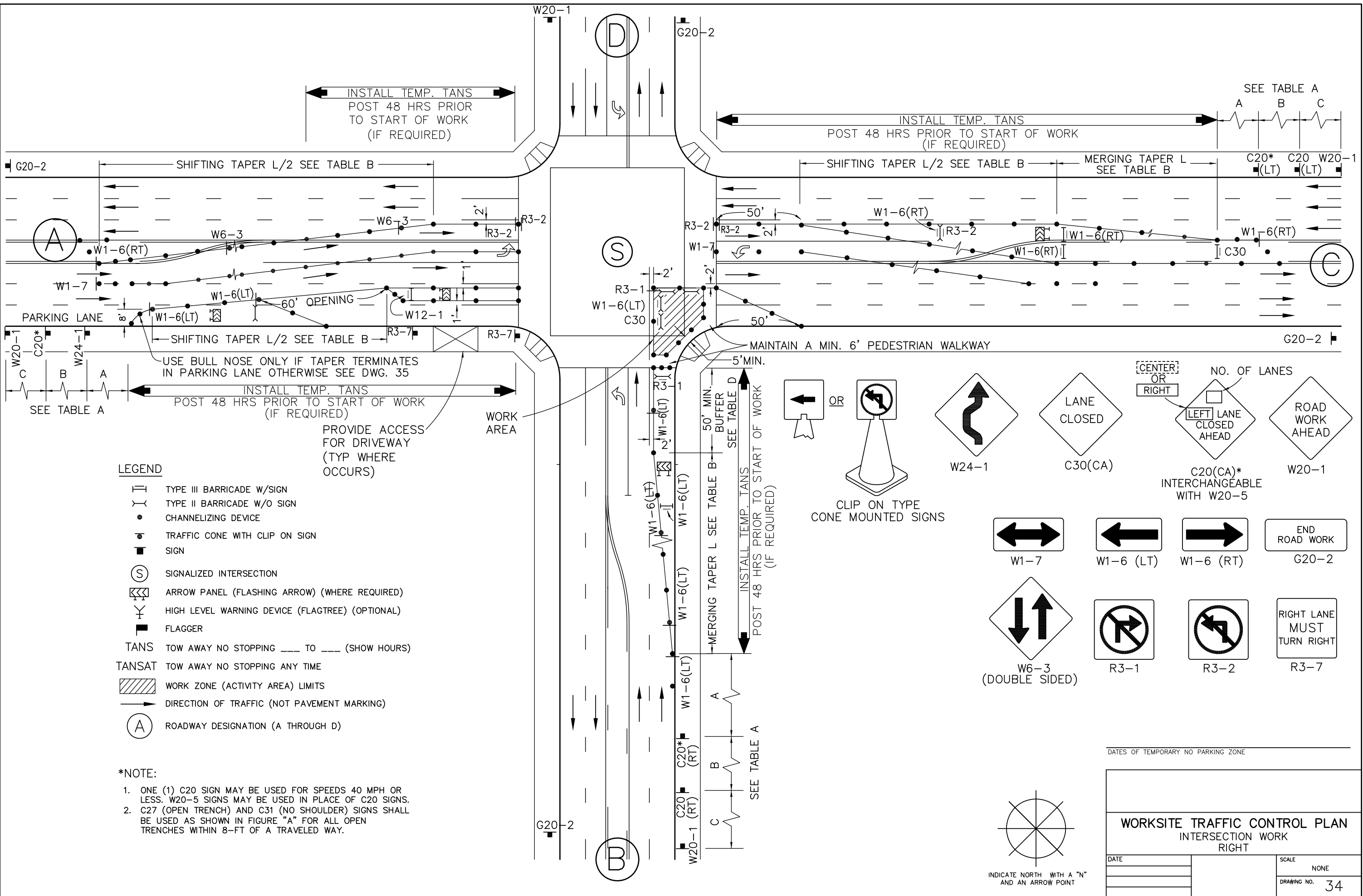

LEGEND

- TYPE III BARRICADE W/SIGN
- TYPE II BARRICADE W/O SIGN
- CHANNELIZING DEVICE
- TRAFFIC CONE WITH CLIP ON SIGN
- SIGN
- SIGNALIZED INTERSECTION
- ARROW PANEL (FLASHING ARROW) (WHERE REQUIRED)
- HIGH LEVEL WARNING DEVICE (FLAGTREE) (OPTIONAL)
- FLAGGER
- TANS** TOW AWAY NO STOPPING ____ TO ____ (SHOW HOURS)
- TANSAT** TOW AWAY NO STOPPING ANY TIME
- WORK ZONE (ACTIVITY AREA) LIMITS
- DIRECTION OF TRAFFIC (NOT PAVEMENT MARKING)
- ROADWAY DESIGNATION (A THROUGH D)

***NOTE:**

1. ONE (1) C20 SIGN MAY BE USED FOR SPEEDS 40 MPH OR LESS. W20-5 SIGNS MAY BE USED IN PLACE OF C20 SIGNS.
2. C27 (OPEN TRENCH) AND C31 (NO SHOULDER) SIGNS SHALL BE USED AS SHOWN IN FIGURE "A" FOR ALL OPEN TRENCHES WITHIN 8-FT OF A TRAVELED WAY.

CLIP ON TYPE CONE MOUNTED SIGNS

	OR					
W1-7		W24-1	C30(CA)	C20(CA)* INTERCHANGEABLE WITH W20-5	W20-1	
W6-3 (DOUBLE SIDED)		R3-1	R3-2	R3-7		

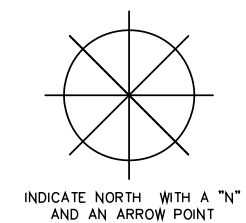

DATES OF TEMPORARY NO PARKING ZONE _____

WORKSITE TRAFFIC CONTROL PLAN INTERSECTION WORK RIGHT		
DATE		SCALE
		NONE
		DRAWING NO.
		34



CONSTRUCTION NOTE:
ALL DRIVEWAYS TO REMAIN OPEN (WHENEVER POSSIBLE) THROUGHOUT TRAFFIC CONTROL ZONE



SEE TABLE 'A'-'F' FOR SIGN AND CHANNELIZER DEVICE SPACING AND TAPER LENGTH

SPEED	APPROACH STREET	TAPER LENGTH	SIGN SPACING	CHANNELIZER SPACING

SEE TABLE 'A'-'F' FOR SIGN AND CHANNELIZER DEVICE SPACING AND TAPER LENGTH

SPEED	APPROACH STREET	TAPER LENGTH	SIGN SPACING	CHANNELIZER SPACING

ABBREVIATIONS:

- S = Sign Spacing
- Min = Minimum
- LT = Left
- RT = Right
- LTP = Lane Traffic Panel
- TANSAT = Tow Away, No Stopping Anytime
- TANS = Tow Away, No Stopping

— CHART A —
MINIMUM RECOMMENDED DELINEATOR/CONE & SIGN PLACEMENT

POSTED SPEED LIMIT	TAPER LENGTH FOR 12-FT LANE			CHANNELIZER SPACING		SIGN SPACING (ADVANCE OF TAPER & BETWEEN SIGNS)
	MERGING	SHIFTING	SHOULDER	TAPER	TANGENT	
20 MPH	80 FT.	40 FT.	27 FT.	20 FT.	40 FT.	100 FT.
25 MPH	125 FT.	63 FT.	42 FT.	25 FT.	63 FT.	100 FT.
30 MPH	180 FT.	90 FT.	60 FT.	30 FT.	90 FT.	350 FT.
35 MPH	245 FT.	123 FT.	82 FT.	35 FT.	123 FT.	350 FT.
40 MPH	320 FT.	160 FT.	107 FT.	40 FT.	160 FT.	350 FT.
* 45 MPH	540 FT.	270 FT.	180 FT.	45 FT.	270 FT.	500 FT.
* 50 MPH	600 FT.	300 FT.	200 FT.	50 FT.	300 FT.	500 FT.
* 55+MPH	660 FT.	330 FT.	220 FT.	55 FT.	330 FT.	PER TABLE 'A'

NOTES

1. A Flashing Arrow sign shall be used for each lane closed.
- *2. Two lane closure signs (C-20) shall be used on the approach to a lane closure with speeds of 45 mph or greater.

NOTE: This chart based on 12-foot wide lanes.

For lane widths greater than 12 feet, use the following formulae:

Taper formula:

$$L = S \times W \text{ for speeds of 45 mph or more.}$$

$$L = \frac{WS^2}{60} \text{ for speeds of 40 mph or less.}$$

Where:

L = Minimum length of taper.

S = Numerical value of posted speed limit prior to work or 85 percentile speed.

W = Width of offset.

i.e.: 50 mph and 19' lane; $L = 50 \times 19 = 950$ feet

REV. APR-2010 C:\JUTCM-DWG35.DWG

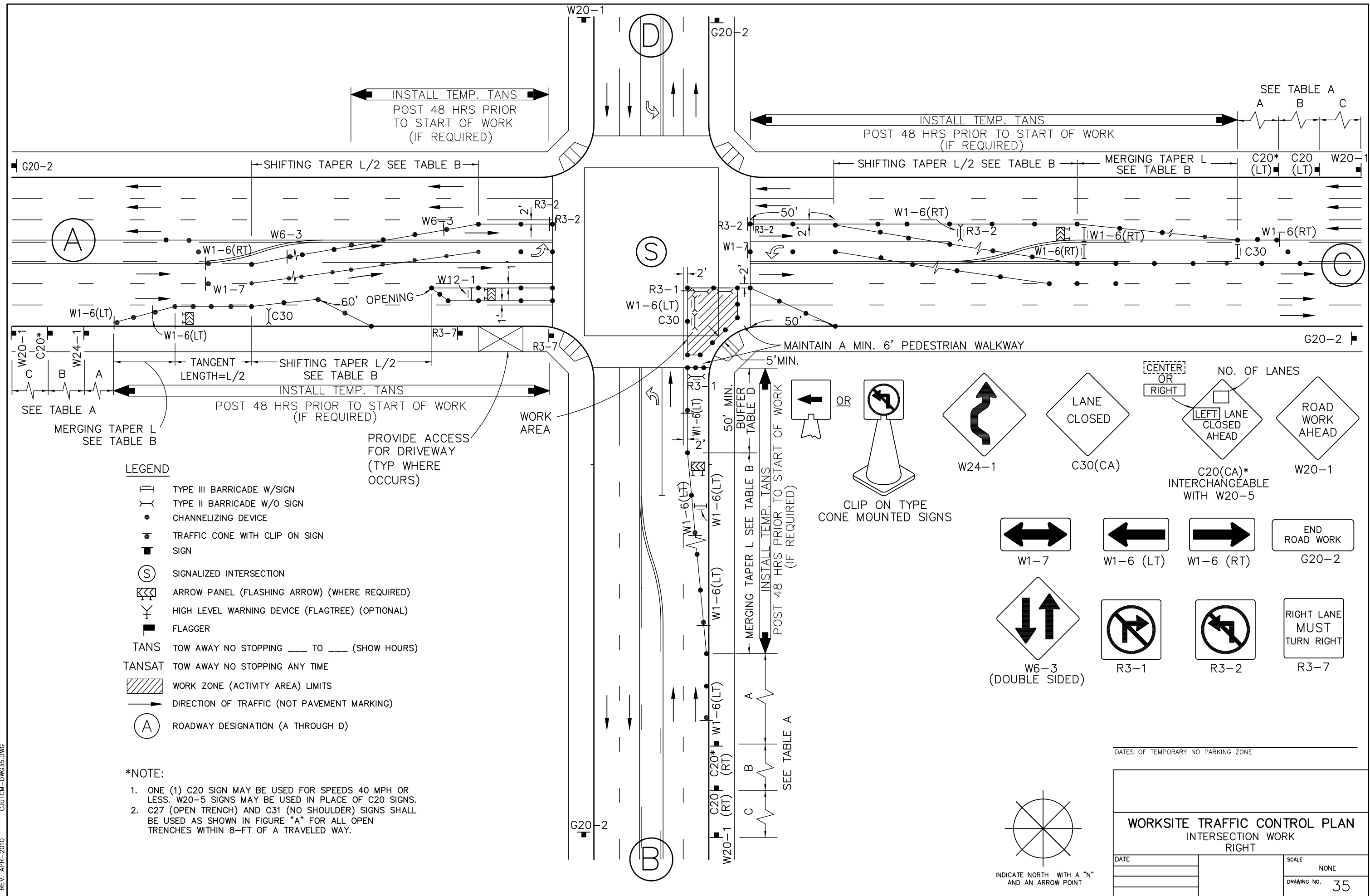

LEGEND

- TYPE III BARRICADE W/SIGN
- TYPE II BARRICADE W/O SIGN
- CHANNELIZING DEVICE
- TRAFFIC CONE WITH CLIP ON SIGN
- SIGN
- SIGNALIZED INTERSECTION
- ARROW PANEL (FLASHING ARROW) (WHERE REQUIRED)
- HIGH LEVEL WARNING DEVICE (FLAGTREE) (OPTIONAL)
- FLAGGER
- TANS** TOW AWAY NO STOPPING ____ TO ____ (SHOW HOURS)
- TANSAT** TOW AWAY NO STOPPING ANY TIME
- WORK ZONE (ACTIVITY AREA) LIMITS
- DIRECTION OF TRAFFIC (NOT PAVEMENT MARKING)
- ROADWAY DESIGNATION (A THROUGH D)

***NOTE:**

1. ONE (1) C20 SIGN MAY BE USED FOR SPEEDS 40 MPH OR LESS. W20-5 SIGNS MAY BE USED IN PLACE OF C20 SIGNS.
2. C27 (OPEN TRENCH) AND C31 (NO SHOULDER) SIGNS SHALL BE USED AS SHOWN IN FIGURE "A" FOR ALL OPEN TRENCHES WITHIN 8-FT OF A TRAVELED WAY.

CLIP ON TYPE CONE MOUNTED SIGNS

W24-1	C30(CA)	C20(CA)* INTERCHANGEABLE WITH W20-5	W20-1
W1-7	W1-6 (LT)	W1-6 (RT)	END ROAD WORK G20-2
W6-3 (DOUBLE SIDED)	R3-1	R3-2	RIGHT LANE MUST TURN RIGHT R3-7

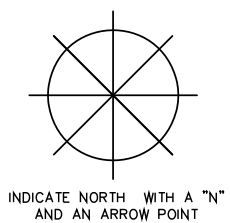

DATES OF TEMPORARY NO PARKING ZONE _____

WORKSITE TRAFFIC CONTROL PLAN INTERSECTION WORK RIGHT		
DATE		SCALE NONE
		DRAWING NO. 35



CONSTRUCTION NOTE:
 ALL DRIVEWAYS TO REMAIN OPEN (WHENEVER POSSIBLE) THROUGHOUT TRAFFIC CONTROL ZONE



SEE TABLE 'A'-'F' FOR SIGN AND CHANNELIZER DEVICE SPACING AND TAPER LENGTH

SPEED	APPROACH STREET	TAPER LENGTH	SIGN SPACING	CHANNELIZER SPACING

SEE TABLE 'A'-'F' FOR SIGN AND CHANNELIZER DEVICE SPACING AND TAPER LENGTH

SPEED	APPROACH STREET	TAPER LENGTH	SIGN SPACING	CHANNELIZER SPACING

ABBREVIATIONS:

- S = Sign Spacing
- Min = Minimum
- LT = Left
- RT = Right
- LTP = Lane Traffic Panel
- TANSAT = Tow Away, No Stopping Anytime
- TANS = Tow Away, No Stopping

— CHART A —
 MINIMUM RECOMMENDED DELINEATOR/CONE & SIGN PLACEMENT

POSTED SPEED LIMIT	TAPER LENGTH FOR 12-FT LANE			CHANNELIZER SPACING		SIGN SPACING (ADVANCE OF TAPER & BETWEEN SIGNS)
	MERGING	SHIFTING	SHOULDER	TAPER	TANGENT	
20 MPH	80 FT.	40 FT.	27 FT.	20 FT.	40 FT.	100 FT.
25 MPH	125 FT.	63 FT.	42 FT.	25 FT.	63 FT.	100 FT.
30 MPH	180 FT.	90 FT.	60 FT.	30 FT.	90 FT.	350 FT.
35 MPH	245 FT.	123 FT.	82 FT.	35 FT.	123 FT.	350 FT.
40 MPH	320 FT.	160 FT.	107 FT.	40 FT.	160 FT.	350 FT.
* 45 MPH	540 FT.	270 FT.	180 FT.	45 FT.	270 FT.	500 FT.
* 50 MPH	600 FT.	300 FT.	200 FT.	50 FT.	300 FT.	500 FT.
* 55+MPH	660 FT.	330 FT.	220 FT.	55 FT.	330 FT.	PER TABLE 'A'

NOTES

1. A Flashing Arrow sign shall be used for each lane closed.
- *2. Two lane closure signs (C-20) shall be used on the approach to a lane closure with speeds of 45 mph or greater.

NOTE: This chart based on 12-foot wide lanes.

For lane widths greater than 12 feet, use the following formulae:

Taper formula:

$$L = S \times W \text{ for speeds of 45 mph or more.}$$

$$L = \frac{WS^2}{60} \text{ for speeds of 40 mph or less.}$$

Where:

L = Minimum length of taper.

S = Numerical value of posted speed limit prior to work or 85 percentile speed.

W = Width of offset.

i.e.: 50 mph and 19' lane; $L = 50 \times 19 = 950$ feet

REV. APR-2010 C:\JUTCM-DWG36.DWG

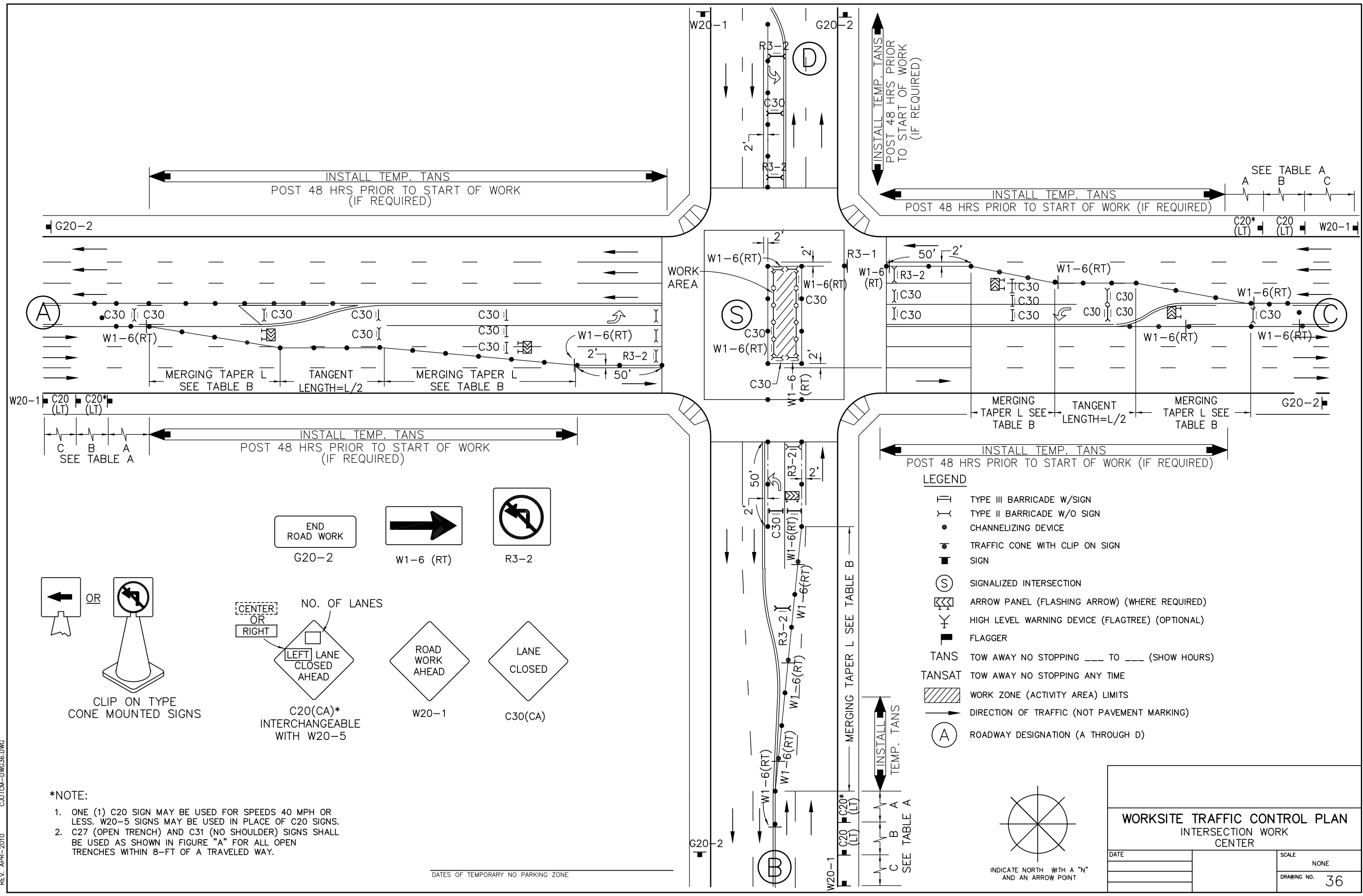

LEGEND

- TYPE III BARRICADE W/SIGN
- TYPE II BARRICADE W/O SIGN
- CHANNELIZING DEVICE
- TRAFFIC CONE WITH CLIP ON SIGN
- SIGN
- SIGNALIZED INTERSECTION
- ARROW PANEL (FLASHING ARROW) (WHERE REQUIRED)
- HIGH LEVEL WARNING DEVICE (FLAGTREE) (OPTIONAL)
- FLAGGER
- TANS TOW AWAY NO STOPPING ___ TO ___ (SHOW HOURS)
- TANSAT TOW AWAY NO STOPPING ANY TIME
- WORK ZONE (ACTIVITY AREA) LIMITS
- DIRECTION OF TRAFFIC (NOT PAVEMENT MARKING)
- ROADWAY DESIGNATION (A THROUGH D)

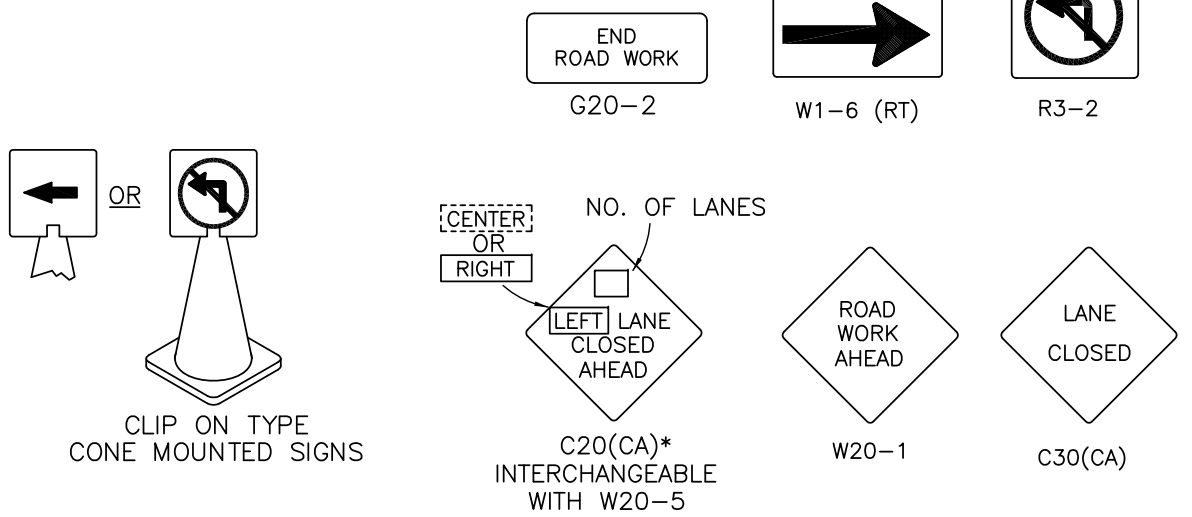

***NOTE:**

- ONE (1) C20 SIGN MAY BE USED FOR SPEEDS 40 MPH OR LESS. W20-5 SIGNS MAY BE USED IN PLACE OF C20 SIGNS.
- C27 (OPEN TRENCH) AND C31 (NO SHOULDER) SIGNS SHALL BE USED AS SHOWN IN FIGURE "A" FOR ALL OPEN TRENCHES WITHIN 8-FT OF A TRAVELED WAY.

DATES OF TEMPORARY NO PARKING ZONE _____



WORKSITE TRAFFIC CONTROL PLAN INTERSECTION WORK CENTER		
DATE		SCALE
		NONE
		DRAWING NO.
		36

NO. OF LANES

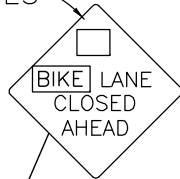

C20 (CA)

CONSTRUCTION NOTE:
PLACE BIKE LANE CLOSED AHEAD SIGN (C20) HALF THE DISTANCE BETWEEN THE FIRST AND SECOND SIGNS

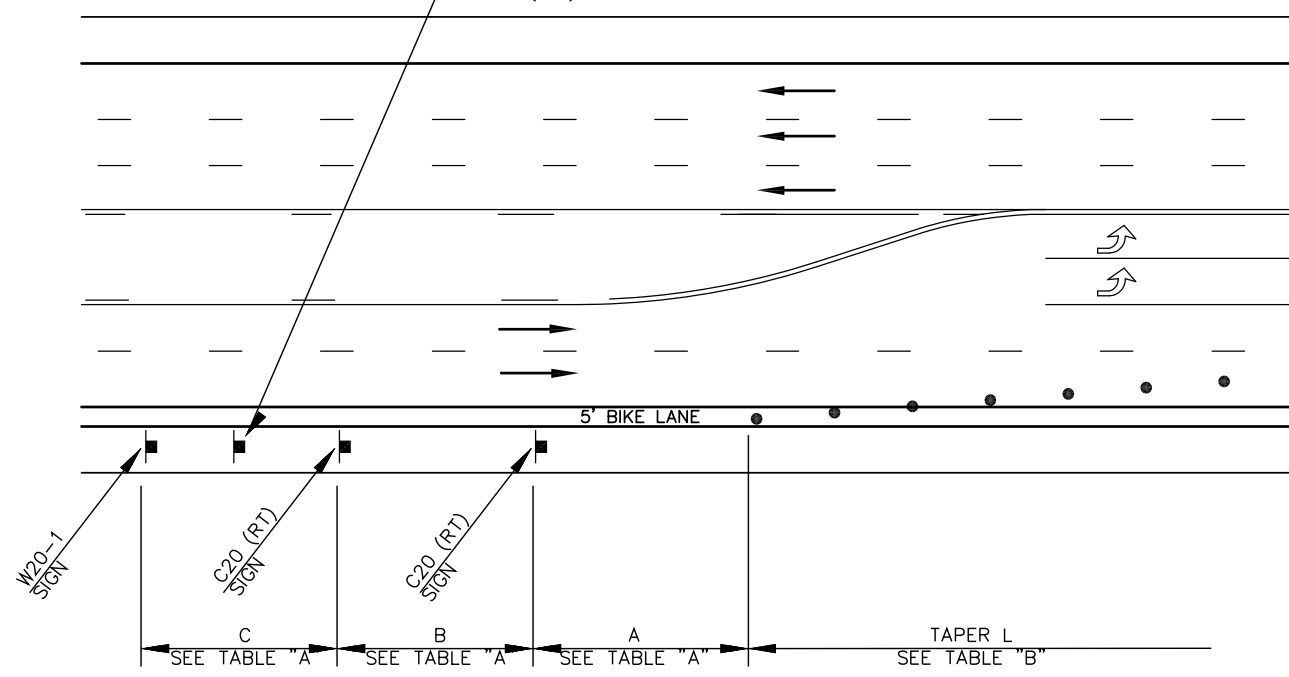

PLACEMENT OF BIKE LANE CLOSURE SIGN
(IF NECESSARY)

CONSTRUCTION NOTE:
ALL DRIVEWAYS TO REMAIN OPEN (WHENEVER POSSIBLE) THROUGHOUT TRAFFIC CONTROL ZONE

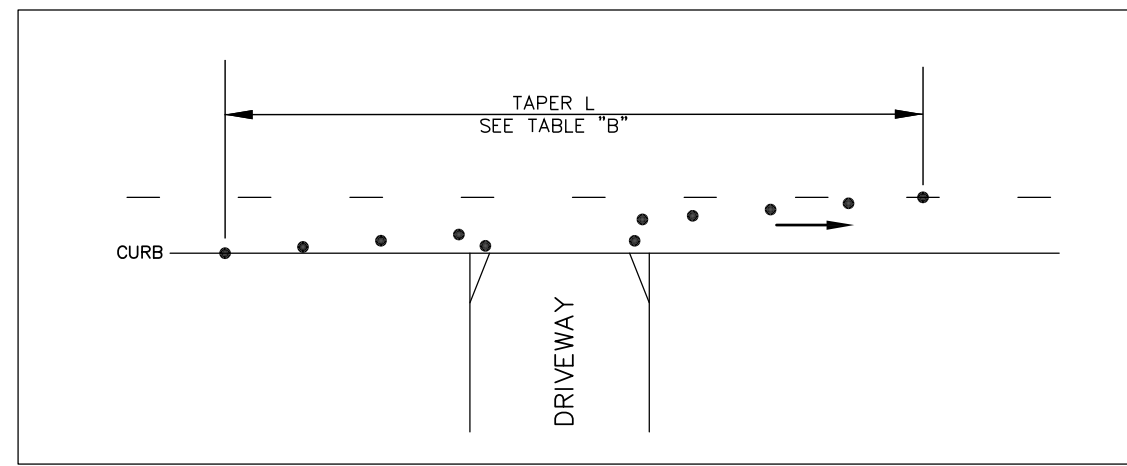

SEE TABLE 'A'-'F' FOR SIGN AND CHANNELIZER DEVICE SPACING AND TAPER LENGTH

SPEED	APPROACH STREET	TAPER LENGTH	SIGN SPACING	CHANNELIZER SPACING

SEE TABLE 'A'-'F' FOR SIGN AND CHANNELIZER DEVICE SPACING AND TAPER LENGTH

SPEED	APPROACH STREET	TAPER LENGTH	SIGN SPACING	CHANNELIZER SPACING

ABBREVIATIONS:

- S = Sign Spacing
- Min = Minimum
- LT = Left
- RT = Right
- LTP = Lane Traffic Panel
- TANSAT = Tow Away, No Stopping Anytime
- TANS = Tow Away, No Stopping

— CHART A —
MINIMUM RECOMMENDED DELINEATOR/CONE & SIGN PLACEMENT

POSTED SPEED LIMIT	TAPER LENGTH FOR 12-FT LANE			CHANNELIZER SPACING		SIGN SPACING (ADVANCE OF TAPER & BETWEEN SIGNS)
	MERGING	SHIFTING	SHOULDER	TAPER	TANGENT	
20 MPH	80 FT.	40 FT.	27 FT.	20 FT.	40 FT.	100 FT.
25 MPH	125 FT.	63 FT.	42 FT.	25 FT.	63 FT.	100 FT.
30 MPH	180 FT.	90 FT.	60 FT.	30 FT.	90 FT.	350 FT.
35 MPH	245 FT.	123 FT.	82 FT.	35 FT.	123 FT.	350 FT.
40 MPH	320 FT.	160 FT.	107 FT.	40 FT.	160 FT.	350 FT.
* 45 MPH	540 FT.	270 FT.	180 FT.	45 FT.	270 FT.	500 FT.
* 50 MPH	600 FT.	300 FT.	200 FT.	50 FT.	300 FT.	500 FT.
* 55+MPH	660 FT.	330 FT.	220 FT.	55 FT.	330 FT.	PER TABLE 'A'

NOTES

1. A Flashing Arrow sign shall be used for each lane closed.
- *2. Two lane closure signs (C-20) shall be used on the approach to a lane closure with speeds of 45 mph or greater.

NOTE: This chart based on 12-foot wide lanes.

For lane widths greater than 12 feet, use the following formulae:

Taper formula:

$$L = S \times W \text{ for speeds of 45 mph or more.}$$

$$L = \frac{WS^2}{60} \text{ for speeds of 40 mph or less.}$$

Where:

- L = Minimum length of taper.
- S = Numerical value of posted speed limit prior to work or 85 percentile speed.
- W = Width of offset.

i.e.: 50 mph and 19' lane; $L = 50 \times 19 = 950$ feet

REV. APR-2010 C:\JTCM-DWG37.DWG

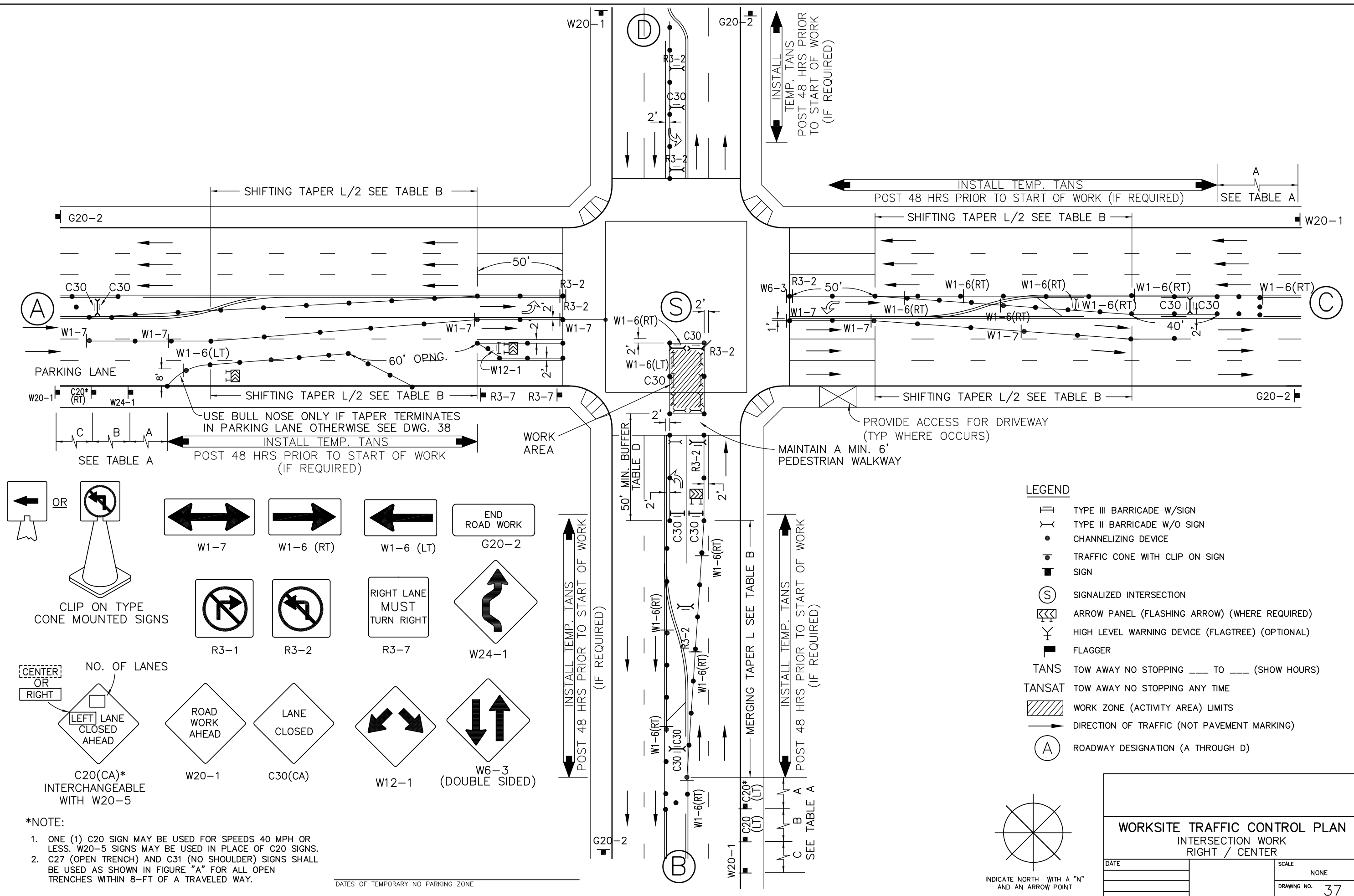

CLIP ON TYPE CONE MOUNTED SIGNS

OR

W1-7

W1-6 (RT)

W1-6 (LT)

END ROAD WORK

R3-1

R3-2

R3-7

W24-1

C20(CA)* INTERCHANGEABLE WITH W20-5

W20-1

C30(CA)

W12-1

W6-3 (DOUBLE SIDED)

NO. OF LANES

[CENTER] OR [RIGHT]

LEFT LANE CLOSED AHEAD

ROAD WORK AHEAD

LANE CLOSED

DATES OF TEMPORARY NO PARKING ZONE

LEGEND

- TYPE III BARRICADE W/SIGN
- TYPE II BARRICADE W/O SIGN
- CHANNELIZING DEVICE
- TRAFFIC CONE WITH CLIP ON SIGN
- SIGN
- SIGNALIZED INTERSECTION
- ARROW PANEL (FLASHING ARROW) (WHERE REQUIRED)
- HIGH LEVEL WARNING DEVICE (FLAGTREE) (OPTIONAL)
- FLAGGER
- TANS TOW AWAY NO STOPPING ____ TO ____ (SHOW HOURS)
- TANSAT TOW AWAY NO STOPPING ANY TIME
- WORK ZONE (ACTIVITY AREA) LIMITS
- DIRECTION OF TRAFFIC (NOT PAVEMENT MARKING)
- ROADWAY DESIGNATION (A THROUGH D)

***NOTE:**

- ONE (1) C20 SIGN MAY BE USED FOR SPEEDS 40 MPH OR LESS. W20-5 SIGNS MAY BE USED IN PLACE OF C20 SIGNS.
- C27 (OPEN TRENCH) AND C31 (NO SHOULDER) SIGNS SHALL BE USED AS SHOWN IN FIGURE "A" FOR ALL OPEN TRENCHES WITHIN 8-FT OF A TRAVELED WAY.

WORKSITE TRAFFIC CONTROL PLAN		
INTERSECTION WORK		
RIGHT / CENTER		
DATE		SCALE
		NONE
		DRAWING NO.
		37

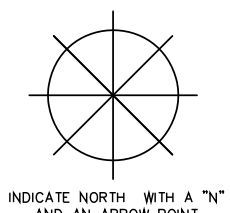



CONSTRUCTION NOTE:
ALL DRIVEWAYS TO REMAIN OPEN (WHENEVER POSSIBLE) THROUGHOUT TRAFFIC CONTROL ZONE

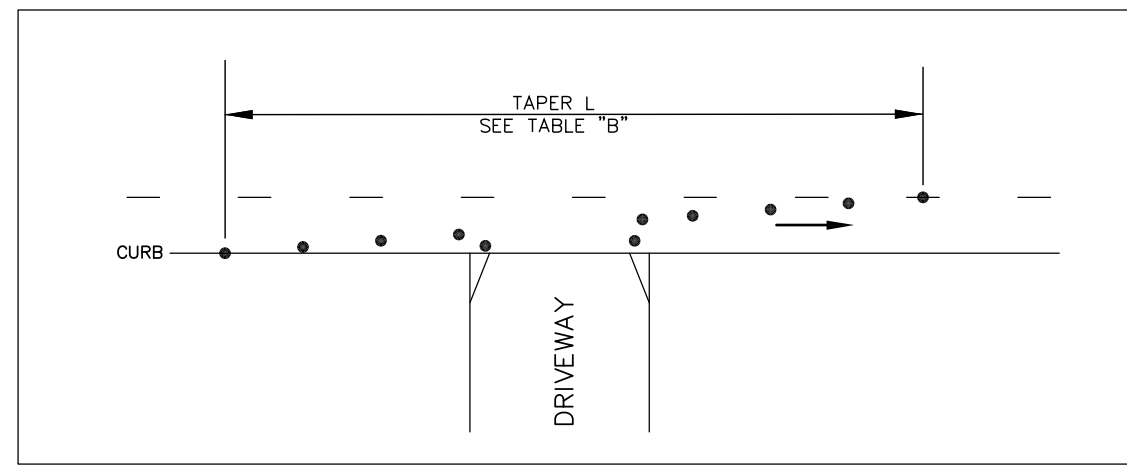

SEE TABLE 'A'-'F' FOR SIGN AND CHANNELIZER DEVICE SPACING AND TAPER LENGTH

SPEED	APPROACH STREET	TAPER LENGTH	SIGN SPACING	CHANNELIZER SPACING

SEE TABLE 'A'-'F' FOR SIGN AND CHANNELIZER DEVICE SPACING AND TAPER LENGTH

SPEED	APPROACH STREET	TAPER LENGTH	SIGN SPACING	CHANNELIZER SPACING

ABBREVIATIONS:

- S = Sign Spacing
- Min = Minimum
- LT = Left
- RT = Right
- LTP = Lane Traffic Panel
- TANSAT = Tow Away, No Stopping Anytime
- TANS = Tow Away, No Stopping

— CHART A —
MINIMUM RECOMMENDED DELINEATOR/CONE & SIGN PLACEMENT

POSTED SPEED LIMIT	TAPER LENGTH FOR 12-FT LANE			CHANNELIZER SPACING		SIGN SPACING (ADVANCE OF TAPER & BETWEEN SIGNS)
	MERGING	SHIFTING	SHOULDER	TAPER	TANGENT	
20 MPH	80 FT.	40 FT.	27 FT.	20 FT.	40 FT.	100 FT.
25 MPH	125 FT.	63 FT.	42 FT.	25 FT.	63 FT.	100 FT.
30 MPH	180 FT.	90 FT.	60 FT.	30 FT.	90 FT.	350 FT.
35 MPH	245 FT.	123 FT.	82 FT.	35 FT.	123 FT.	350 FT.
40 MPH	320 FT.	160 FT.	107 FT.	40 FT.	160 FT.	350 FT.
* 45 MPH	540 FT.	270 FT.	180 FT.	45 FT.	270 FT.	500 FT.
* 50 MPH	600 FT.	300 FT.	200 FT.	50 FT.	300 FT.	500 FT.
* 55+MPH	660 FT.	330 FT.	220 FT.	55 FT.	330 FT.	PER TABLE 'A'

NOTES

1. A Flashing Arrow sign shall be used for each lane closed.
- *2. Two lane closure signs (C-20) shall be used on the approach to a lane closure with speeds of 45 mph or greater.

NOTE: This chart based on 12-foot wide lanes.

For lane widths greater than 12 feet, use the following formulae:

Taper formula:

$$L = S \times W \text{ for speeds of 45 mph or more.}$$

$$L = \frac{WS^2}{60} \text{ for speeds of 40 mph or less.}$$

Where:

L = Minimum length of taper.

S = Numerical value of posted speed limit prior to work or 85 percentile speed.

W = Width of offset.

i.e.: 50 mph and 19' lane; $L = 50 \times 19 = 950$ feet

REV. APR-2010 C:\JUTCM-DWG38.DWG

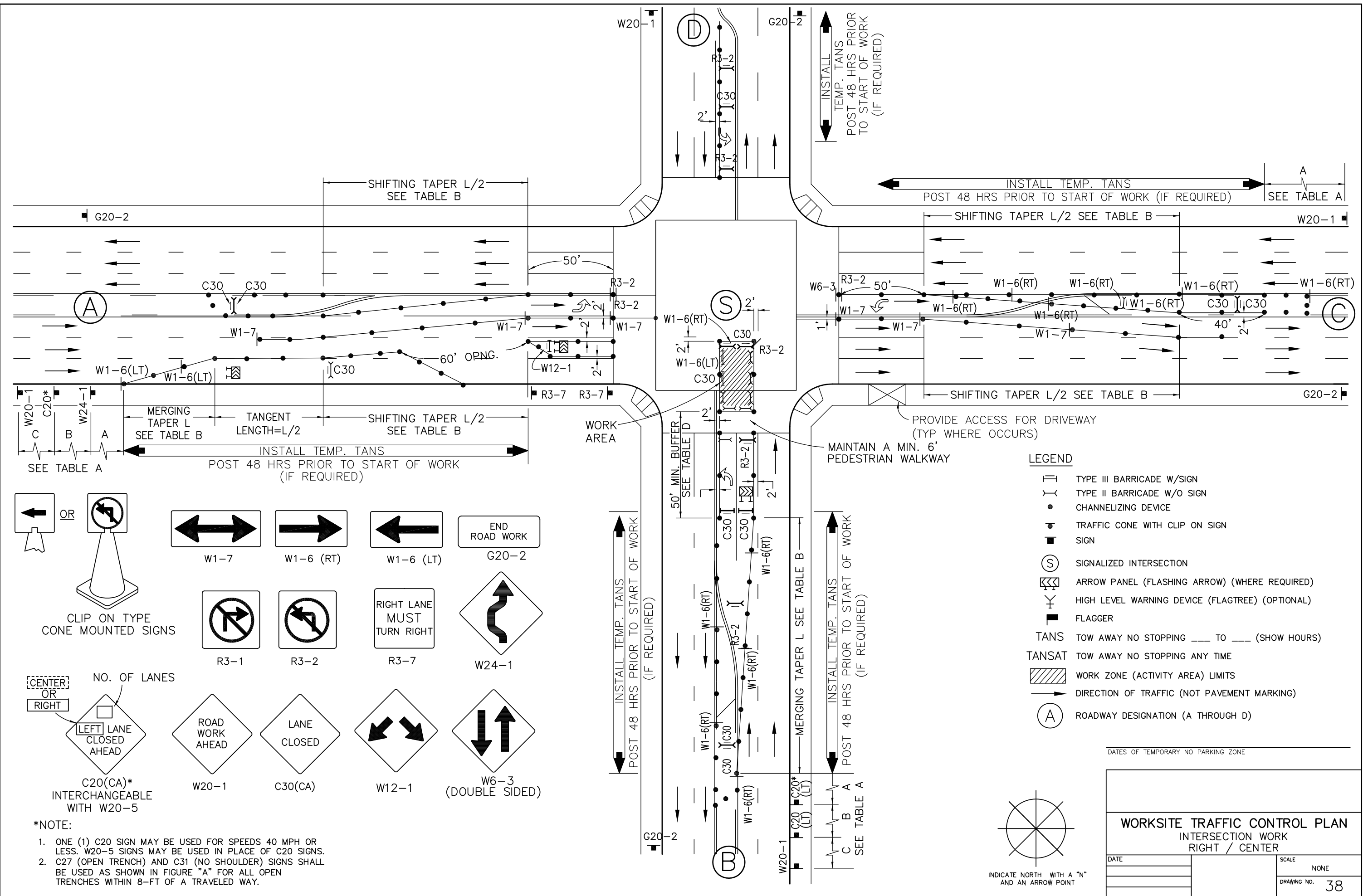

***NOTE:**

- ONE (1) C20 SIGN MAY BE USED FOR SPEEDS 40 MPH OR LESS. W20-5 SIGNS MAY BE USED IN PLACE OF C20 SIGNS.
- C27 (OPEN TRENCH) AND C31 (NO SHOULDER) SIGNS SHALL BE USED AS SHOWN IN FIGURE "A" FOR ALL OPEN TRENCHES WITHIN 8-FT OF A TRAVELED WAY.

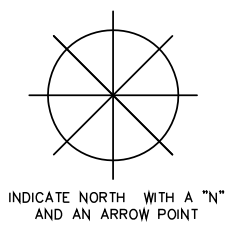

DATES OF TEMPORARY NO PARKING ZONE _____

WORKSITE TRAFFIC CONTROL PLAN		
INTERSECTION WORK RIGHT / CENTER		
DATE		SCALE NONE
		DRAWING NO. 38



CONSTRUCTION NOTE:
ALL DRIVEWAYS TO REMAIN OPEN (WHENEVER POSSIBLE) THROUGHOUT TRAFFIC CONTROL ZONE



SEE TABLE 'A'-'F' FOR SIGN AND CHANNELIZER DEVICE SPACING AND TAPER LENGTH

SPEED	APPROACH STREET	TAPER LENGTH	SIGN SPACING	CHANNELIZER SPACING

SEE TABLE 'A'-'F' FOR SIGN AND CHANNELIZER DEVICE SPACING AND TAPER LENGTH

SPEED	APPROACH STREET	TAPER LENGTH	SIGN SPACING	CHANNELIZER SPACING

ABBREVIATIONS:

- S = Sign Spacing
- Min = Minimum
- LT = Left
- RT = Right
- LTP = Lane Traffic Panel
- TANSAT = Tow Away, No Stopping Anytime
- TANS = Tow Away, No Stopping

— CHART A —
MINIMUM RECOMMENDED DELINEATOR/CONE & SIGN PLACEMENT

POSTED SPEED LIMIT	TAPER LENGTH FOR 12-FT LANE			CHANNELIZER SPACING		SIGN SPACING (ADVANCE OF TAPER & BETWEEN SIGNS)
	MERGING	SHIFTING	SHOULDER	TAPER	TANGENT	
20 MPH	80 FT.	40 FT.	27 FT.	20 FT.	40 FT.	100 FT.
25 MPH	125 FT.	63 FT.	42 FT.	25 FT.	63 FT.	100 FT.
30 MPH	180 FT.	90 FT.	60 FT.	30 FT.	90 FT.	350 FT.
35 MPH	245 FT.	123 FT.	82 FT.	35 FT.	123 FT.	350 FT.
40 MPH	320 FT.	160 FT.	107 FT.	40 FT.	160 FT.	350 FT.
* 45 MPH	540 FT.	270 FT.	180 FT.	45 FT.	270 FT.	500 FT.
* 50 MPH	600 FT.	300 FT.	200 FT.	50 FT.	300 FT.	500 FT.
* 55+MPH	660 FT.	330 FT.	220 FT.	55 FT.	330 FT.	PER TABLE 'A'

NOTES

1. A Flashing Arrow sign shall be used for each lane closed.
- *2. Two lane closure signs (C-20) shall be used on the approach to a lane closure with speeds of 45 mph or greater.

NOTE: This chart based on 12-foot wide lanes.

For lane widths greater than 12 feet, use the following formulae:

Taper formula:

$$L = S \times W \text{ for speeds of 45 mph or more.}$$

$$L = \frac{WS^2}{60} \text{ for speeds of 40 mph or less.}$$

Where:

L = Minimum length of taper.

S = Numerical value of posted speed limit prior to work or 85 percentile speed.

W = Width of offset.

i.e.: 50 mph and 19' lane; $L = 50 \times 19 = 950$ feet

LEGEND

- TYPE III BARRICADE W/SIGN
- TYPE II BARRICADE W/O SIGN
- CHANNELIZING DEVICE
- TRAFFIC CONE WITH CLIP ON SIGN
- SIGN
- SIGNALIZED INTERSECTION
- ARROW PANEL (FLASHING ARROW) (WHERE REQUIRED)
- HIGH LEVEL WARNING DEVICE (FLAGTREE) (OPTIONAL)
- FLAGGER
- TANS TOW AWAY NO STOPPING ____ TO ____ (SHOW HOURS)
- TANSAT TOW AWAY NO STOPPING ANY TIME
- WORK ZONE (ACTIVITY AREA) LIMITS
- DIRECTION OF TRAFFIC (NOT PAVEMENT MARKING)
- ROADWAY DESIGNATION (A THROUGH D)

USE BULL NOSE ONLY IF TAPER TERMINATES IN PARKING LANE, OTHERWISE EXTEND TAPER USING APPROPRIATE LENGTH (SEE TABLE B)

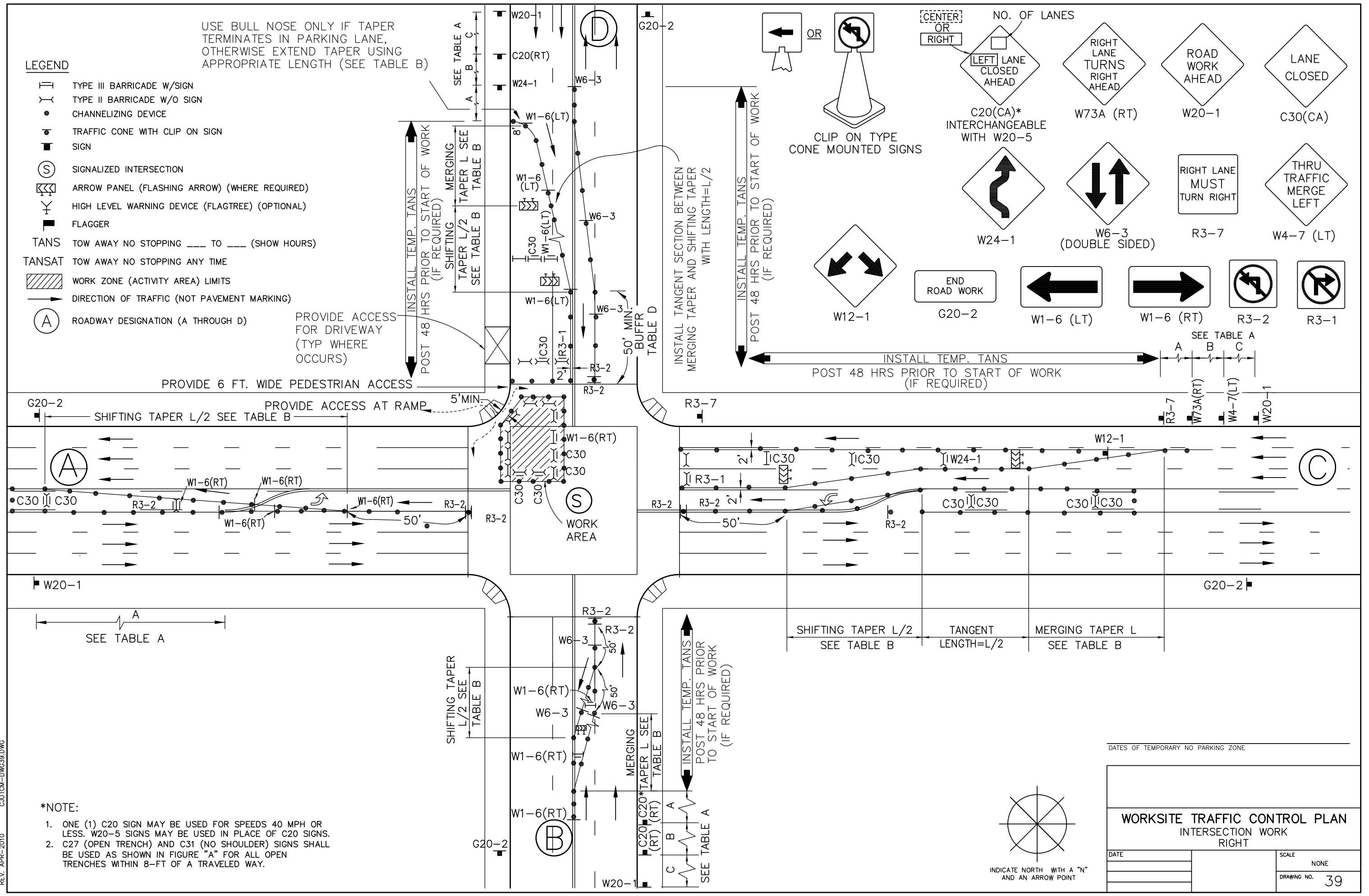

REV. APR-2010
 C:\JUTCM-DWG39.DWG

- *NOTE:**
1. ONE (1) C20 SIGN MAY BE USED FOR SPEEDS 40 MPH OR LESS. W20-5 SIGNS MAY BE USED IN PLACE OF C20 SIGNS.
 2. C27 (OPEN TRENCH) AND C31 (NO SHOULDER) SIGNS SHALL BE USED AS SHOWN IN FIGURE "A" FOR ALL OPEN TRENCHES WITHIN 8-FT OF A TRAVELED WAY.

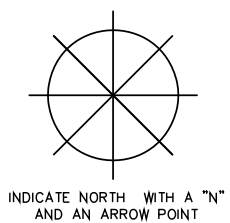

DATES OF TEMPORARY NO PARKING ZONE

WORKSITE TRAFFIC CONTROL PLAN INTERSECTION WORK RIGHT		
DATE		SCALE
		NONE
		DRAWING NO.
		39



CONSTRUCTION NOTE:
ALL DRIVEWAYS TO REMAIN OPEN (WHENEVER POSSIBLE) THROUGHOUT TRAFFIC CONTROL ZONE



SEE TABLE 'A'-'F' FOR SIGN AND CHANNELIZER DEVICE SPACING AND TAPER LENGTH

SPEED	APPROACH STREET	TAPER LENGTH	SIGN SPACING	CHANNELIZER SPACING

SEE TABLE 'A'-'F' FOR SIGN AND CHANNELIZER DEVICE SPACING AND TAPER LENGTH

SPEED	APPROACH STREET	TAPER LENGTH	SIGN SPACING	CHANNELIZER SPACING

ABBREVIATIONS:

- S = Sign Spacing
- Min = Minimum
- LT = Left
- RT = Right
- LTP = Lane Traffic Panel
- TANSAT = Tow Away, No Stopping Anytime
- TANS = Tow Away, No Stopping

— CHART A —
MINIMUM RECOMMENDED DELINEATOR/CONE & SIGN PLACEMENT

POSTED SPEED LIMIT	TAPER LENGTH FOR 12-FT LANE			CHANNELIZER SPACING		SIGN SPACING (ADVANCE OF TAPER & BETWEEN SIGNS)
	MERGING	SHIFTING	SHOULDER	TAPER	TANGENT	
20 MPH	80 FT.	40 FT.	27 FT.	20 FT.	40 FT.	100 FT.
25 MPH	125 FT.	63 FT.	42 FT.	25 FT.	63 FT.	100 FT.
30 MPH	180 FT.	90 FT.	60 FT.	30 FT.	90 FT.	350 FT.
35 MPH	245 FT.	123 FT.	82 FT.	35 FT.	123 FT.	350 FT.
40 MPH	320 FT.	160 FT.	107 FT.	40 FT.	160 FT.	350 FT.
* 45 MPH	540 FT.	270 FT.	180 FT.	45 FT.	270 FT.	500 FT.
* 50 MPH	600 FT.	300 FT.	200 FT.	50 FT.	300 FT.	500 FT.
* 55+MPH	660 FT.	330 FT.	220 FT.	55 FT.	330 FT.	PER TABLE 'A'

NOTES

1. A Flashing Arrow sign shall be used for each lane closed.
- *2. Two lane closure signs (C-20) shall be used on the approach to a lane closure with speeds of 45 mph or greater.

NOTE: This chart based on 12-foot wide lanes.

For lane widths greater than 12 feet, use the following formulae:

Taper formula:

$$L = S \times W \text{ for speeds of 45 mph or more.}$$

$$L = \frac{WS^2}{60} \text{ for speeds of 40 mph or less.}$$

Where:

L = Minimum length of taper.

S = Numerical value of posted speed limit prior to work or 85 percentile speed.

W = Width of offset.

i.e.: 50 mph and 19' lane; $L = 50 \times 19 = 950$ feet

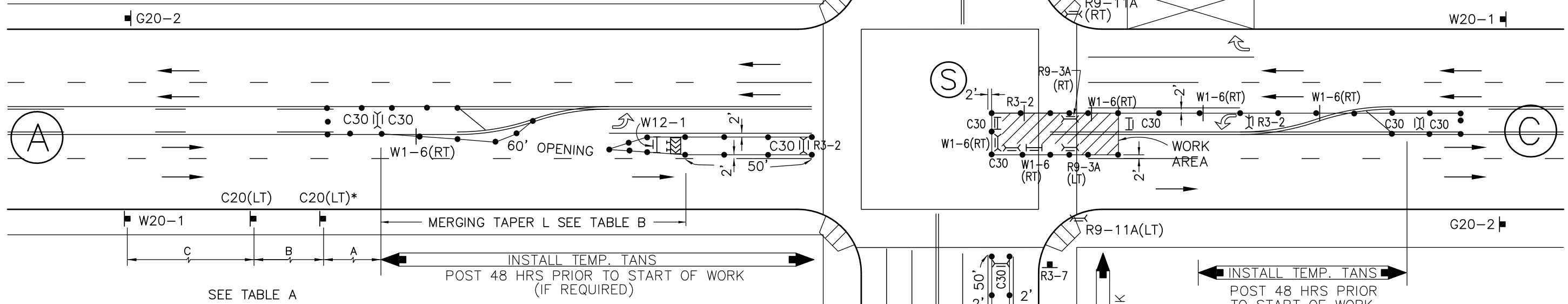
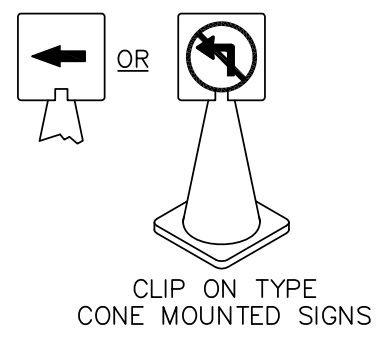
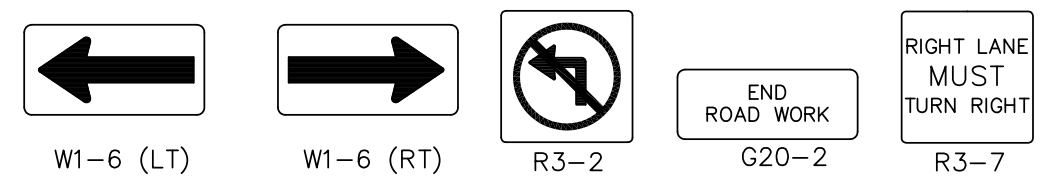
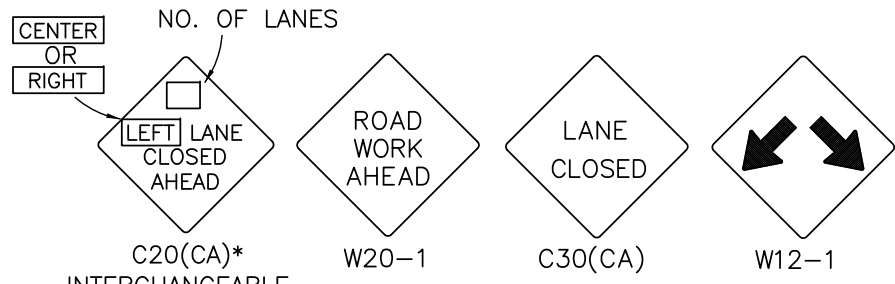

- LEGEND**
- TYPE III BARRICADE W/SIGN
 - TYPE II BARRICADE W/O SIGN
 - CHANNELIZING DEVICE
 - TRAFFIC CONE WITH CLIP ON SIGN
 - SIGN
 - SIGNALIZED INTERSECTION
 - ARROW PANEL (FLASHING ARROW) (WHERE REQUIRED)
 - HIGH LEVEL WARNING DEVICE (FLAGTREE) (OPTIONAL)
 - FLAGGER
 - TANS TOW AWAY NO STOPPING ____ TO ____ (SHOW HOURS)
 - TANSAT TOW AWAY NO STOPPING ANY TIME
 - WORK ZONE (ACTIVITY AREA) LIMITS
 - DIRECTION OF TRAFFIC (NOT PAVEMENT MARKING)
 - ROADWAY DESIGNATION (A THROUGH D)

***NOTE:**

1. ONE (1) C20 SIGN MAY BE USED FOR SPEEDS 40 MPH OR LESS. W20-5 SIGNS MAY BE USED IN PLACE OF C20 SIGNS.
2. C27 (OPEN TRENCH) AND C31 (NO SHOULDER) SIGNS SHALL BE USED AS SHOWN IN FIGURE "A" FOR ALL OPEN TRENCHES WITHIN 8-FT OF A TRAVELED WAY.

REV. APR-2010 C:\JTCM-DWG40.DWG

DATES OF TEMPORARY NO PARKING ZONE _____

WORKSITE TRAFFIC CONTROL PLAN
INTERSECTION WORK
FAR LEFT / RIGHT

DATE	SCALE
	NONE
	DRAWING NO. 40

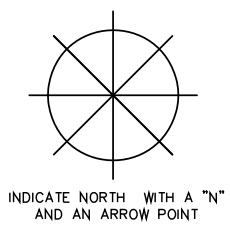

NO. OF LANES

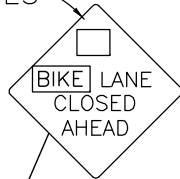

C20 (CA)

CONSTRUCTION NOTE:
PLACE BIKE LANE CLOSED AHEAD SIGN (C20) HALF THE DISTANCE BETWEEN THE FIRST AND SECOND SIGNS

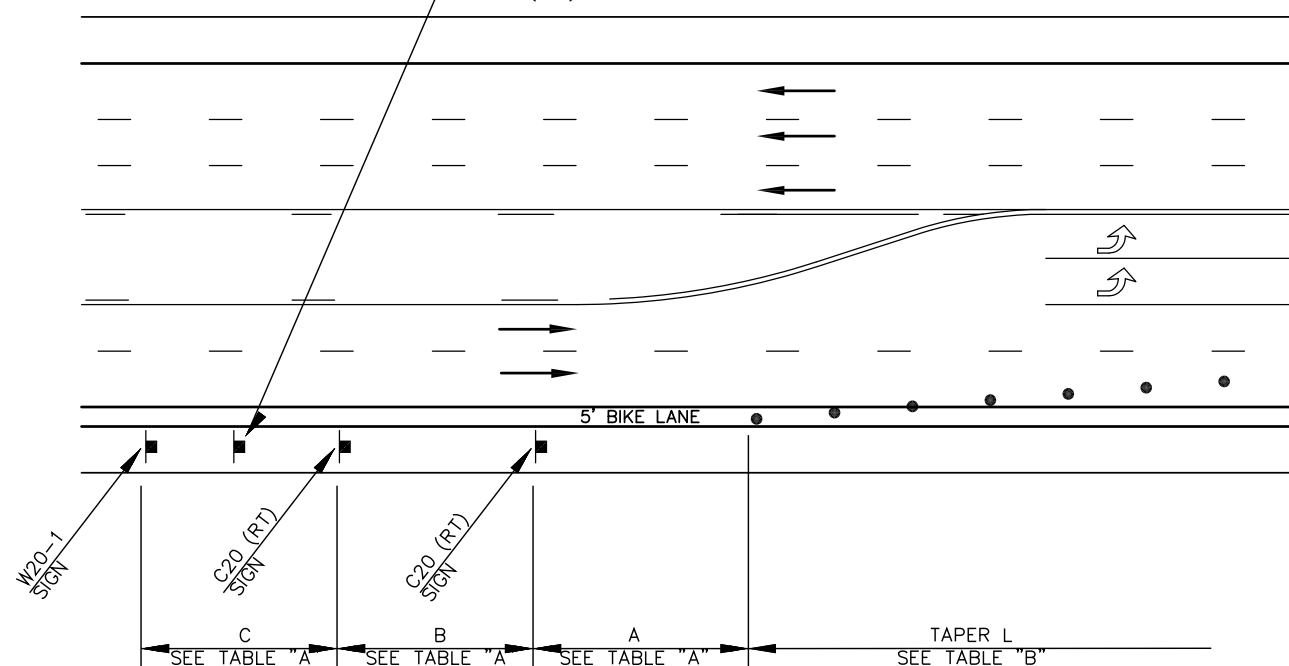

PLACEMENT OF BIKE LANE CLOSURE SIGN
(IF NECESSARY)

CONSTRUCTION NOTE:
ALL DRIVEWAYS TO REMAIN OPEN (WHENEVER POSSIBLE) THROUGHOUT TRAFFIC CONTROL ZONE

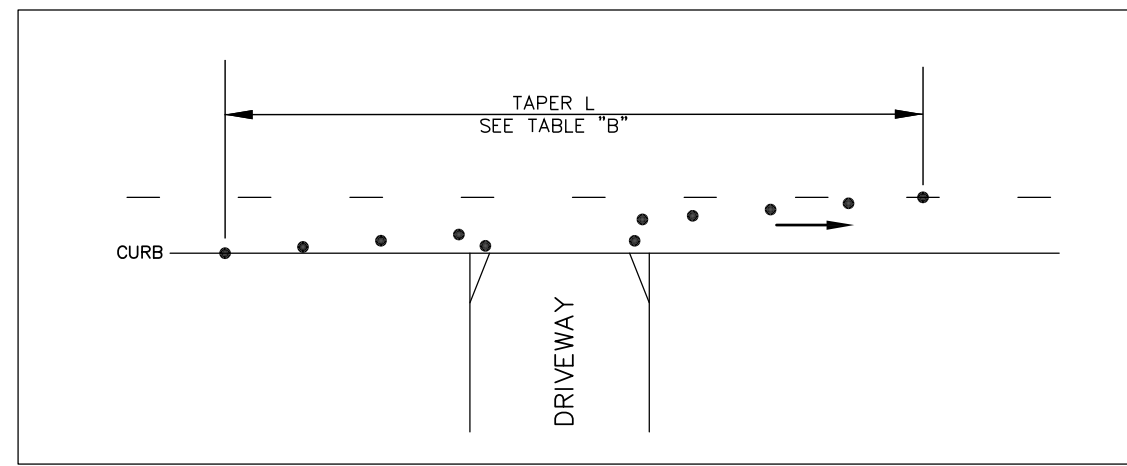

SEE TABLE 'A'-'F' FOR SIGN AND CHANNELIZER DEVICE SPACING AND TAPER LENGTH

SPEED	APPROACH STREET	TAPER LENGTH	SIGN SPACING	CHANNELIZER SPACING

SEE TABLE 'A'-'F' FOR SIGN AND CHANNELIZER DEVICE SPACING AND TAPER LENGTH

SPEED	APPROACH STREET	TAPER LENGTH	SIGN SPACING	CHANNELIZER SPACING

ABBREVIATIONS:
S = Sign Spacing
Min = Minimum
LT = Left
RT = Right
LTP = Lane Traffic Panel
TANSAT = Tow Away, No Stopping Anytime
TANS = Tow Away, No Stopping

CHART A
MINIMUM RECOMMENDED DELINEATOR/CONE & SIGN PLACEMENT

POSTED SPEED LIMIT	TAPER LENGTH FOR 12-FT LANE			CHANNELIZER SPACING		SIGN SPACING (ADVANCE OF TAPER & BETWEEN SIGNS)
	MERGING	SHIFTING	SHOULDER	TAPER	TANGENT	
20 MPH	80 FT.	40 FT.	27 FT.	20 FT.	40 FT.	100 FT.
25 MPH	125 FT.	63 FT.	42 FT.	25 FT.	63 FT.	100 FT.
30 MPH	180 FT.	90 FT.	60 FT.	30 FT.	90 FT.	350 FT.
35 MPH	245 FT.	123 FT.	82 FT.	35 FT.	123 FT.	350 FT.
40 MPH	320 FT.	160 FT.	107 FT.	40 FT.	160 FT.	350 FT.
* 45 MPH	540 FT.	270 FT.	180 FT.	45 FT.	270 FT.	500 FT.
* 50 MPH	600 FT.	300 FT.	200 FT.	50 FT.	300 FT.	500 FT.
* 55+MPH	660 FT.	330 FT.	220 FT.	55 FT.	330 FT.	PER TABLE 'A'

NOTES

1. A Flashing Arrow sign shall be used for each lane closed.
- *2. Two lane closure signs (C-20) shall be used on the approach to a lane closure with speeds of 45 mph or greater.

NOTE: This chart based on 12-foot wide lanes. For lane widths greater than 12 feet, use the following formulae:

Taper formula:
 $L = S \times W$ for speeds of 45 mph or more.
 $L = \frac{WS^2}{60}$ for speeds of 40 mph or less.

Where:
 L = Minimum length of taper.
 S = Numerical value of posted speed limit prior to work or 85 percentile speed.
 W = Width of offset.

i.e.: 50 mph and 19' lane; $L = 50 \times 19 = 950$ feet

REV. APR-2010 C:\JITCM-DWG41.DWG

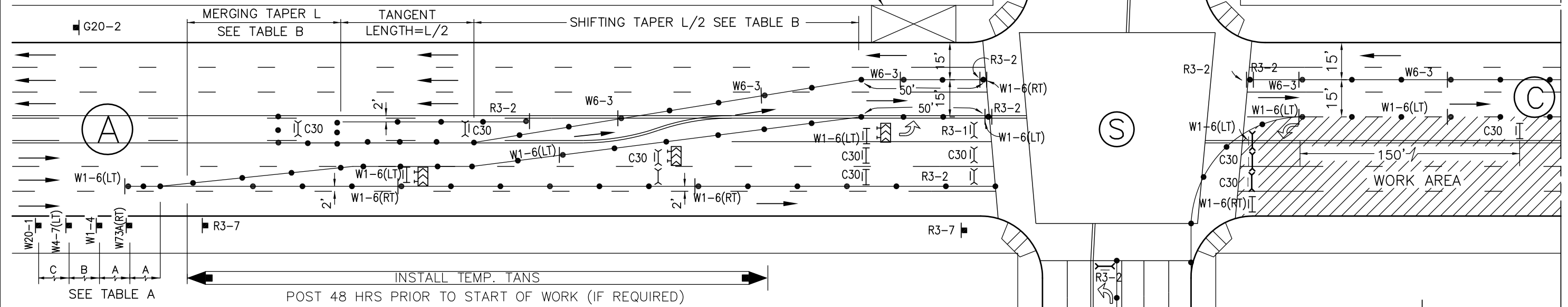
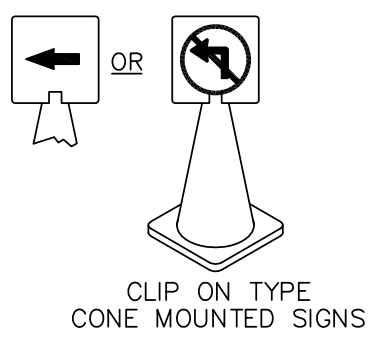
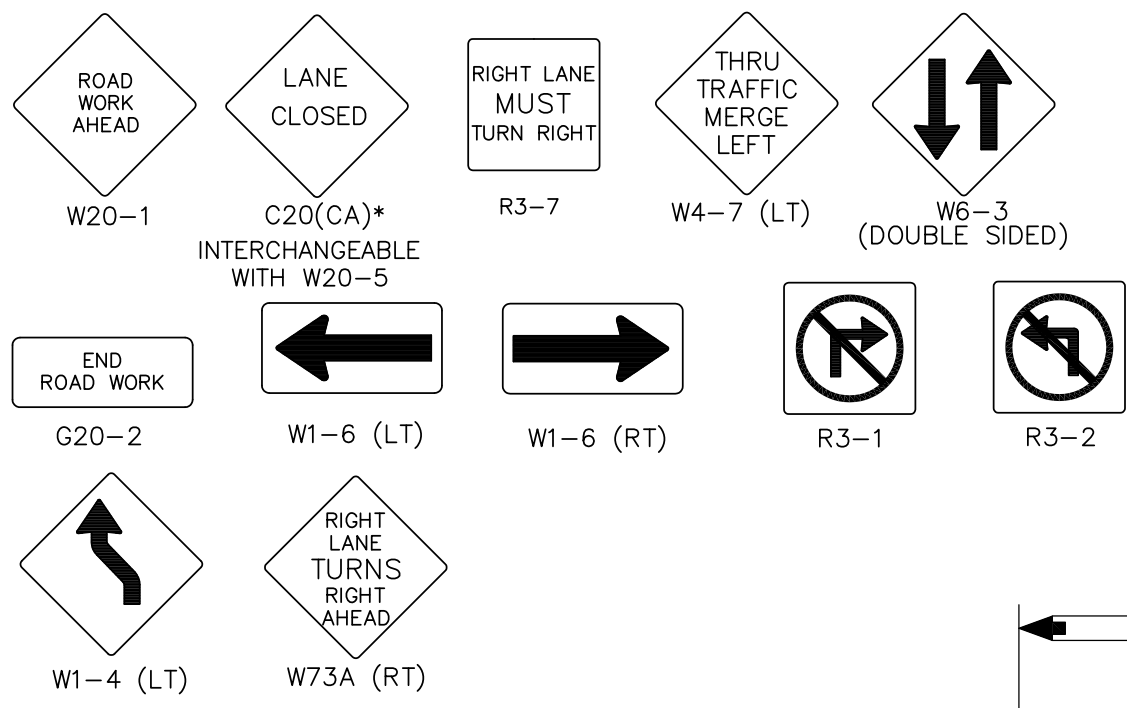

- LEGEND**
- TYPE III BARRICADE W/SIGN
 - TYPE II BARRICADE W/O SIGN
 - CHANNELIZING DEVICE
 - TRAFFIC CONE WITH CLIP ON SIGN
 - SIGN
 - SIGNALIZED INTERSECTION
 - ARROW PANEL (FLASHING ARROW) (WHERE REQUIRED)
 - HIGH LEVEL WARNING DEVICE (FLAGTREE) (OPTIONAL)
 - FLAGGER
 - TANS** TOW AWAY NO STOPPING ____ TO ____ (SHOW HOURS)
 - TANSAT** TOW AWAY NO STOPPING ANY TIME
 - WORK ZONE (ACTIVITY AREA) LIMITS
 - DIRECTION OF TRAFFIC (NOT PAVEMENT MARKING)
 - ROADWAY DESIGNATION (A THROUGH D)

***NOTE:**

- ONE (1) C20 SIGN MAY BE USED FOR SPEEDS 40 MPH OR LESS. W20-5 SIGNS MAY BE USED IN PLACE OF C20 SIGNS.
- C27 (OPEN TRENCH) AND C31 (NO SHOULDER) SIGNS SHALL BE USED AS SHOWN IN FIGURE "A" FOR ALL OPEN TRENCHES WITHIN 8-FT OF A TRAVELED WAY.

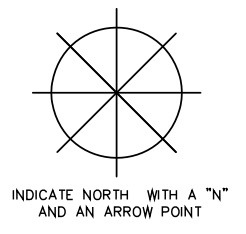

DATES OF TEMPORARY NO PARKING ZONE _____

WORKSITE TRAFFIC CONTROL PLAN		
HALF STREET CLOSURE FAR SIDE		
DATE		SCALE
		NONE
		DRAWING NO.
		41

MATCHLINE SEE SHEET 42

NO. OF LANES

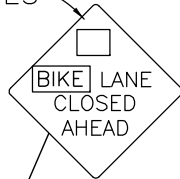

C20 (CA)

CONSTRUCTION NOTE:
PLACE BIKE LANE CLOSED AHEAD SIGN (C20) HALF THE DISTANCE BETWEEN THE FIRST AND SECOND SIGNS

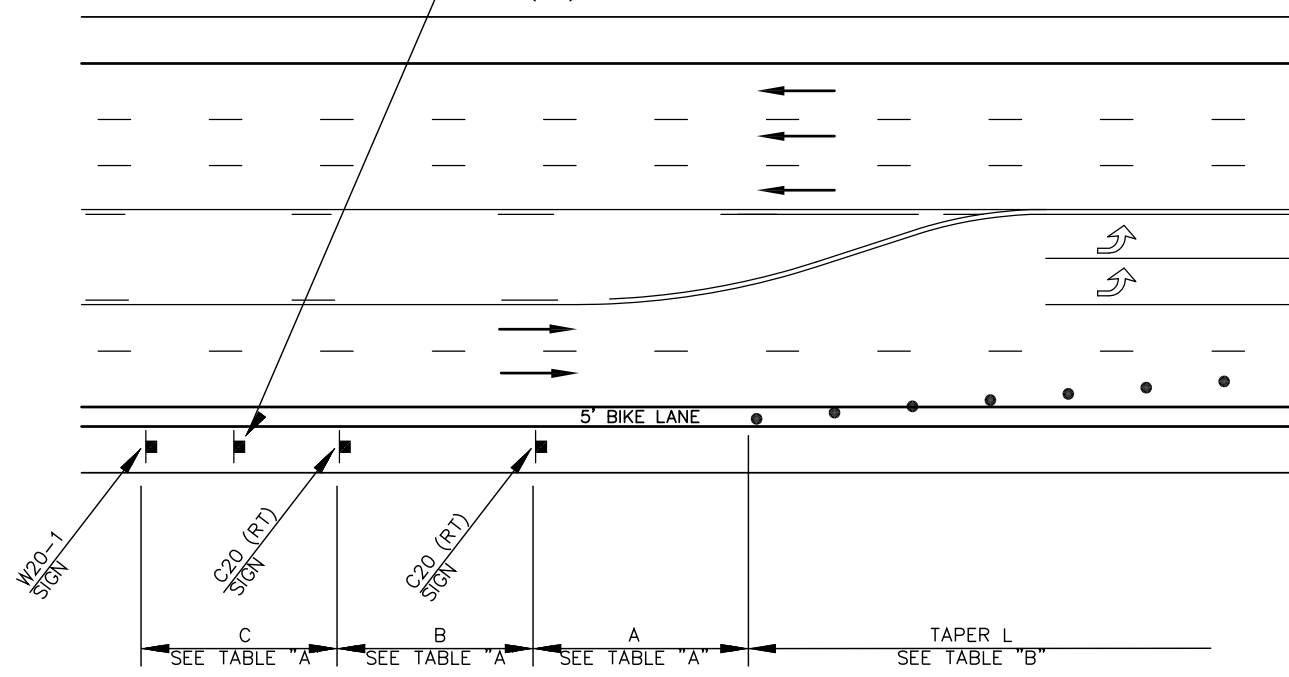

PLACEMENT OF BIKE LANE CLOSURE SIGN
(IF NECESSARY)

CONSTRUCTION NOTE:
ALL DRIVEWAYS TO REMAIN OPEN (WHENEVER POSSIBLE) THROUGHOUT TRAFFIC CONTROL ZONE

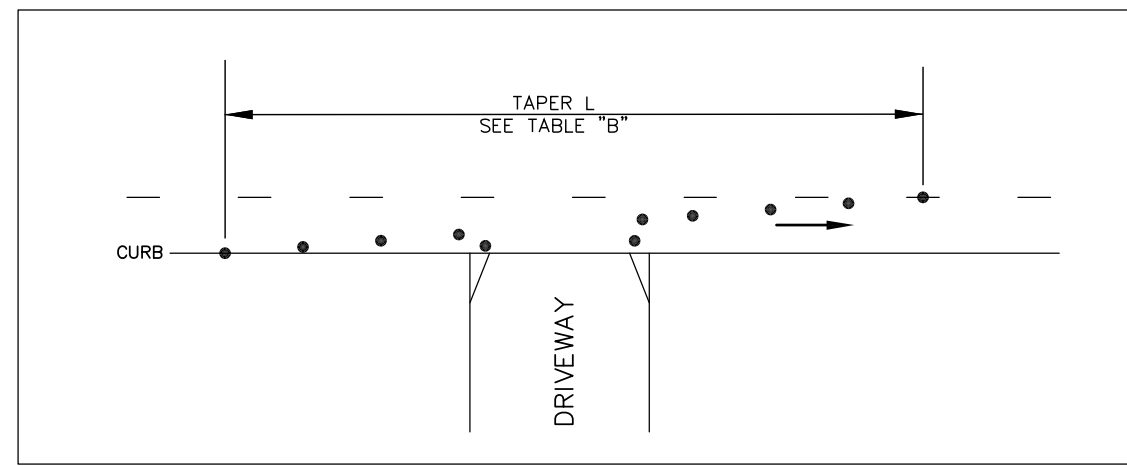

SEE TABLE 'A'-'F' FOR SIGN AND CHANNELIZER DEVICE SPACING AND TAPER LENGTH

SPEED	APPROACH STREET	TAPER LENGTH	SIGN SPACING	CHANNELIZER SPACING

SEE TABLE 'A'-'F' FOR SIGN AND CHANNELIZER DEVICE SPACING AND TAPER LENGTH

SPEED	APPROACH STREET	TAPER LENGTH	SIGN SPACING	CHANNELIZER SPACING

ABBREVIATIONS:

- S = Sign Spacing
- Min = Minimum
- LT = Left
- RT = Right
- LTP = Lane Traffic Panel
- TANSAT = Tow Away, No Stopping Anytime
- TANS = Tow Away, No Stopping

— CHART A —
MINIMUM RECOMMENDED DELINEATOR/CONE & SIGN PLACEMENT

POSTED SPEED LIMIT	TAPER LENGTH FOR 12-FT LANE			CHANNELIZER SPACING		SIGN SPACING (ADVANCE OF TAPER & BETWEEN SIGNS)
	MERGING	SHIFTING	SHOULDER	TAPER	TANGENT	
20 MPH	80 FT.	40 FT.	27 FT.	20 FT.	40 FT.	100 FT.
25 MPH	125 FT.	63 FT.	42 FT.	25 FT.	63 FT.	100 FT.
30 MPH	180 FT.	90 FT.	60 FT.	30 FT.	90 FT.	350 FT.
35 MPH	245 FT.	123 FT.	82 FT.	35 FT.	123 FT.	350 FT.
40 MPH	320 FT.	160 FT.	107 FT.	40 FT.	160 FT.	350 FT.
* 45 MPH	540 FT.	270 FT.	180 FT.	45 FT.	270 FT.	500 FT.
* 50 MPH	600 FT.	300 FT.	200 FT.	50 FT.	300 FT.	500 FT.
* 55+MPH	660 FT.	330 FT.	220 FT.	55 FT.	330 FT.	PER TABLE 'A'

NOTES

1. A Flashing Arrow sign shall be used for each lane closed.
- *2. Two lane closure signs (C-20) shall be used on the approach to a lane closure with speeds of 45 mph or greater.

NOTE: This chart based on 12-foot wide lanes.

For lane widths greater than 12 feet, use the following formulae:

Taper formula:

$$L = S \times W \text{ for speeds of 45 mph or more.}$$

$$L = \frac{WS^2}{60} \text{ for speeds of 40 mph or less.}$$

Where:

- L = Minimum length of taper.
- S = Numerical value of posted speed limit prior to work or 85 percentile speed.
- W = Width of offset.

i.e.: 50 mph and 19' lane; $L = 50 \times 19 = 950$ feet

LEGEND

- TYPE III BARRICADE W/SIGN
- TYPE II BARRICADE W/O SIGN
- CHANNELIZING DEVICE
- TRAFFIC CONE WITH CLIP ON SIGN
- SIGN
- SIGNALIZED INTERSECTION
- ARROW PANEL (FLASHING ARROW) (WHERE REQUIRED)
- HIGH LEVEL WARNING DEVICE (FLAGTREE) (OPTIONAL)
- FLAGGER
- TANS** TOW AWAY NO STOPPING ____ TO ____ (SHOW HOURS)
- TANSAT** TOW AWAY NO STOPPING ANY TIME
- WORK ZONE (ACTIVITY AREA) LIMITS
- DIRECTION OF TRAFFIC (NOT PAVEMENT MARKING)
- ROADWAY DESIGNATION (A THROUGH D)

MATCHLINE
SEE SHEET 41

INSTALL TEMP. TANS

(A)

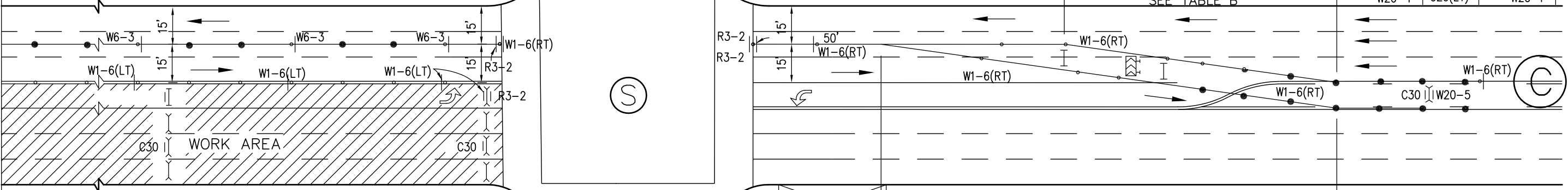

150' TYPICAL
INSTALL TEMP. TANS

POST 48 HOURS PRIOR TO START
OF WORK (IF REQL)

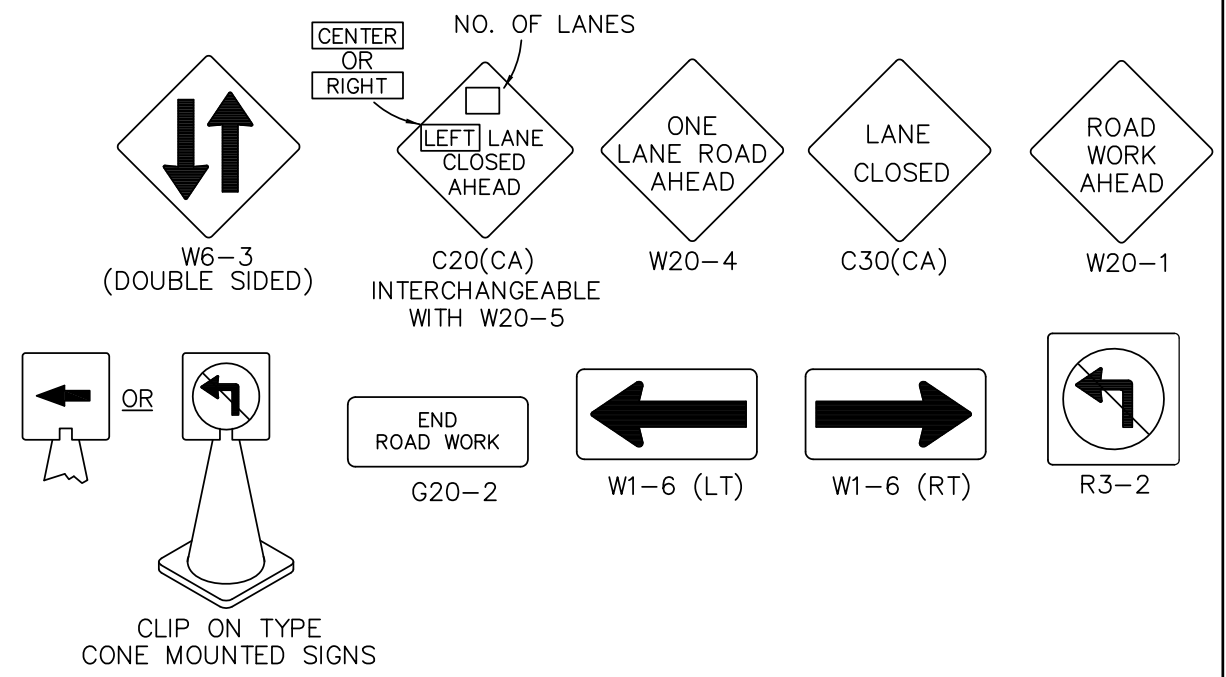

INSTALL TEMP. TANS
SEE TABLE A
A B

Merging Taper L
SEE TABLE B

DATES OF TEMPORARY NO PARKING ZONE

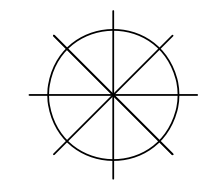

INDICATE NORTH WITH A "N"
AND AN ARROW POINT

WORKSITE TRAFFIC CONTROL PLAN		
HALF STREET CLOSURE NEAR SIDE		
DATE		SCALE
		NONE
		DRAWING NO.
		42



CONSTRUCTION NOTE:
 ALL DRIVEWAYS TO REMAIN OPEN (WHENEVER POSSIBLE) THROUGHOUT TRAFFIC CONTROL ZONE



SEE TABLE 'A'-'F' FOR SIGN AND CHANNELIZER DEVICE SPACING AND TAPER LENGTH

SPEED	APPROACH STREET	TAPER LENGTH	SIGN SPACING	CHANNELIZER SPACING

SEE TABLE 'A'-'F' FOR SIGN AND CHANNELIZER DEVICE SPACING AND TAPER LENGTH

SPEED	APPROACH STREET	TAPER LENGTH	SIGN SPACING	CHANNELIZER SPACING

ABBREVIATIONS:

- S = Sign Spacing
- Min = Minimum
- LT = Left
- RT = Right
- LTP = Lane Traffic Panel
- TANSAT = Tow Away, No Stopping Anytime
- TANS = Tow Away, No Stopping

— CHART A —
 MINIMUM RECOMMENDED DELINEATOR/CONE & SIGN PLACEMENT

POSTED SPEED LIMIT	TAPER LENGTH FOR 12-FT LANE			CHANNELIZER SPACING		SIGN SPACING (ADVANCE OF TAPER & BETWEEN SIGNS)
	MERGING	SHIFTING	SHOULDER	TAPER	TANGENT	
20 MPH	80 FT.	40 FT.	27 FT.	20 FT.	40 FT.	100 FT.
25 MPH	125 FT.	63 FT.	42 FT.	25 FT.	63 FT.	100 FT.
30 MPH	180 FT.	90 FT.	60 FT.	30 FT.	90 FT.	350 FT.
35 MPH	245 FT.	123 FT.	82 FT.	35 FT.	123 FT.	350 FT.
40 MPH	320 FT.	160 FT.	107 FT.	40 FT.	160 FT.	350 FT.
* 45 MPH	540 FT.	270 FT.	180 FT.	45 FT.	270 FT.	500 FT.
* 50 MPH	600 FT.	300 FT.	200 FT.	50 FT.	300 FT.	500 FT.
* 55+MPH	660 FT.	330 FT.	220 FT.	55 FT.	330 FT.	PER TABLE 'A'

NOTES

1. A Flashing Arrow sign shall be used for each lane closed.
- *2. Two lane closure signs (C-20) shall be used on the approach to a lane closure with speeds of 45 mph or greater.

NOTE: This chart based on 12-foot wide lanes.

For lane widths greater than 12 feet, use the following formulae:

Taper formula:

$$L = S \times W \text{ for speeds of 45 mph or more.}$$

$$L = \frac{WS^2}{60} \text{ for speeds of 40 mph or less.}$$

Where:

L = Minimum length of taper.

S = Numerical value of posted speed limit prior to work or 85 percentile speed.

W = Width of offset.

i.e.: 50 mph and 19' lane; $L = 50 \times 19 = 950$ feet

LEGEND

- TYPE III BARRICADE W/SIGN
- TYPE II BARRICADE W/O SIGN
- CHANNELIZING DEVICE
- TRAFFIC CONE WITH CLIP ON SIGN
- SIGN
- SIGNALIZED INTERSECTION
- ARROW PANEL (FLASHING ARROW) (WHERE REQUIRED)
- HIGH LEVEL WARNING DEVICE (FLAGTREE) (OPTIONAL)
- FLAGGER
- TANS TOW AWAY NO STOPPING ____ TO ____ (SHOW HOURS)
- TANSAT TOW AWAY NO STOPPING ANY TIME
- WORK ZONE (ACTIVITY AREA) LIMITS
- DIRECTION OF TRAFFIC (NOT PAVEMENT MARKING)
- ROADWAY DESIGNATION (A THROUGH D)

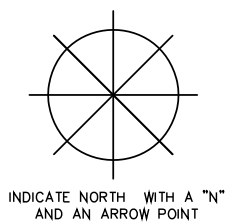
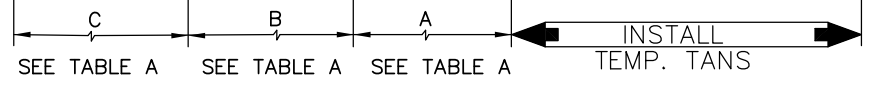
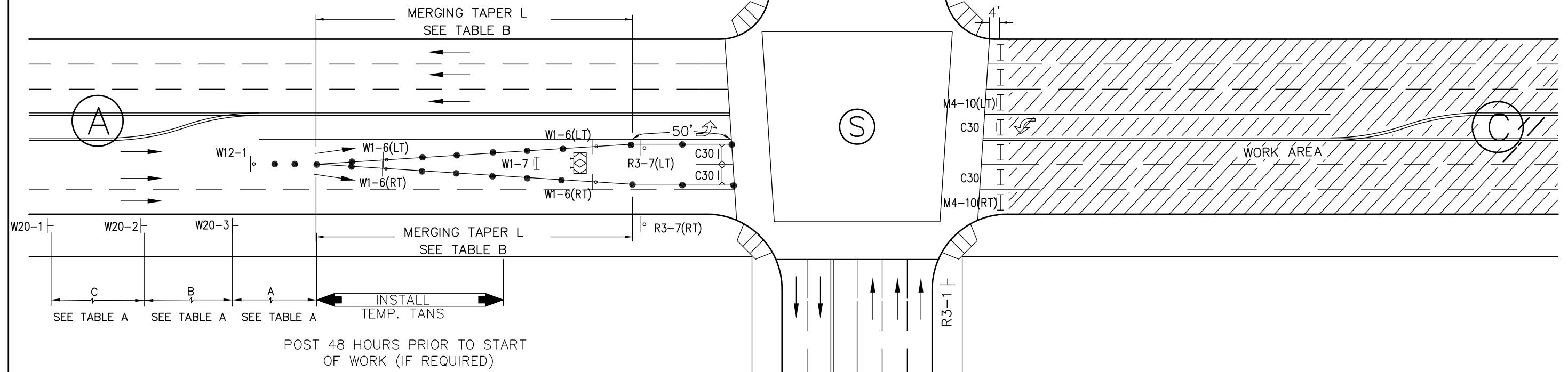
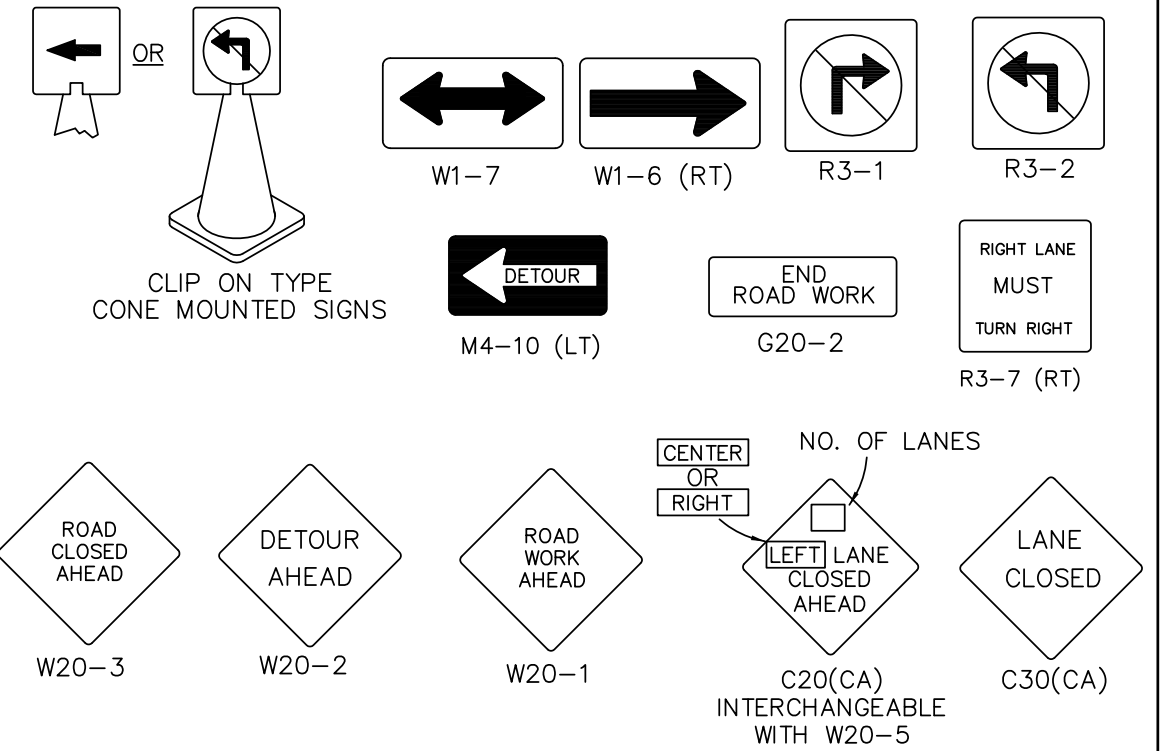

DATES OF TEMPORARY NO PARKING ZONE _____

WORKSITE TRAFFIC CONTROL PLAN		
FULL STREET CLOSURE TWO WAY STREET		
DATE		SCALE
		NONE
		DRAWING NO.
		43



CONSTRUCTION NOTE:
ALL DRIVEWAYS TO REMAIN OPEN (WHENEVER POSSIBLE) THROUGHOUT TRAFFIC CONTROL ZONE



SEE TABLE 'A'-'F' FOR SIGN AND CHANNELIZER DEVICE SPACING AND TAPER LENGTH

SPEED	APPROACH STREET	TAPER LENGTH	SIGN SPACING	CHANNELIZER SPACING

SEE TABLE 'A'-'F' FOR SIGN AND CHANNELIZER DEVICE SPACING AND TAPER LENGTH

SPEED	APPROACH STREET	TAPER LENGTH	SIGN SPACING	CHANNELIZER SPACING

ABBREVIATIONS:

- S = Sign Spacing
- Min = Minimum
- LT = Left
- RT = Right
- LTP = Lane Traffic Panel
- TANSAT = Tow Away, No Stopping Anytime
- TANS = Tow Away, No Stopping

— CHART A —
MINIMUM RECOMMENDED DELINEATOR/CONE & SIGN PLACEMENT

POSTED SPEED LIMIT	TAPER LENGTH FOR 12-FT LANE			CHANNELIZER SPACING		SIGN SPACING (ADVANCE OF TAPER & BETWEEN SIGNS)
	MERGING	SHIFTING	SHOULDER	TAPER	TANGENT	
20 MPH	80 FT.	40 FT.	27 FT.	20 FT.	40 FT.	100 FT.
25 MPH	125 FT.	63 FT.	42 FT.	25 FT.	63 FT.	100 FT.
30 MPH	180 FT.	90 FT.	60 FT.	30 FT.	90 FT.	350 FT.
35 MPH	245 FT.	123 FT.	82 FT.	35 FT.	123 FT.	350 FT.
40 MPH	320 FT.	160 FT.	107 FT.	40 FT.	160 FT.	350 FT.
* 45 MPH	540 FT.	270 FT.	180 FT.	45 FT.	270 FT.	500 FT.
* 50 MPH	600 FT.	300 FT.	200 FT.	50 FT.	300 FT.	500 FT.
* 55+MPH	660 FT.	330 FT.	220 FT.	55 FT.	330 FT.	PER TABLE 'A'

NOTES

1. A Flashing Arrow sign shall be used for each lane closed.
- *2. Two lane closure signs (C-20) shall be used on the approach to a lane closure with speeds of 45 mph or greater.

NOTE: This chart based on 12-foot wide lanes.

For lane widths greater than 12 feet, use the following formulae:

Taper formula:

$$L = S \times W \text{ for speeds of 45 mph or more.}$$

$$L = \frac{WS^2}{60} \text{ for speeds of 40 mph or less.}$$

Where:

L = Minimum length of taper.

S = Numerical value of posted speed limit prior to work or 85 percentile speed.

W = Width of offset.

i.e.: 50 mph and 19' lane; $L = 50 \times 19 = 950$ feet

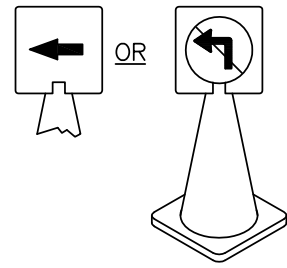

OR
CLIP ON TYPE
CONE MOUNTED SIGNS

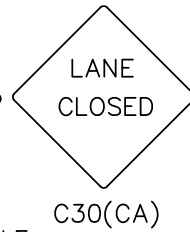
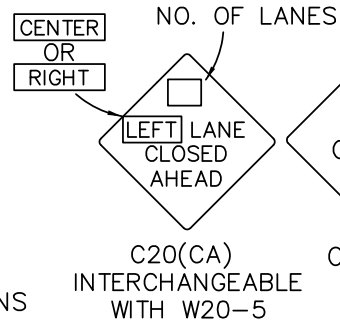

C30(CA)



W20-1



W20-3

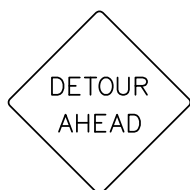

W20-2



M4-10 (LT)



W1-7



W1-6 (RT)

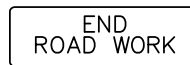

G20-2

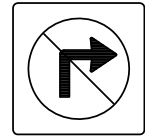

R3-1

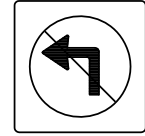

R3-2

LEGEND

- TYPE III BARRICADE W/SIGN
- TYPE II BARRICADE W/O SIGN
- CHANNELIZING DEVICE
- TRAFFIC CONE WITH CLIP ON SIGN
- SIGN
- SIGNALIZED INTERSECTION
- ARROW PANEL (FLASHING ARROW) (WHERE REQUIRED)
- HIGH LEVEL WARNING DEVICE (FLAGTREE) (OPTIONAL)
- FLAGGER
- TANS TOW AWAY NO STOPPING ____ TO ____ (SHOW HOURS)
- TANSAT TOW AWAY NO STOPPING ANY TIME
- WORK ZONE (ACTIVITY AREA) LIMITS
- DIRECTION OF TRAFFIC (NOT PAVEMENT MARKING)
- ROADWAY DESIGNATION (A THROUGH D)

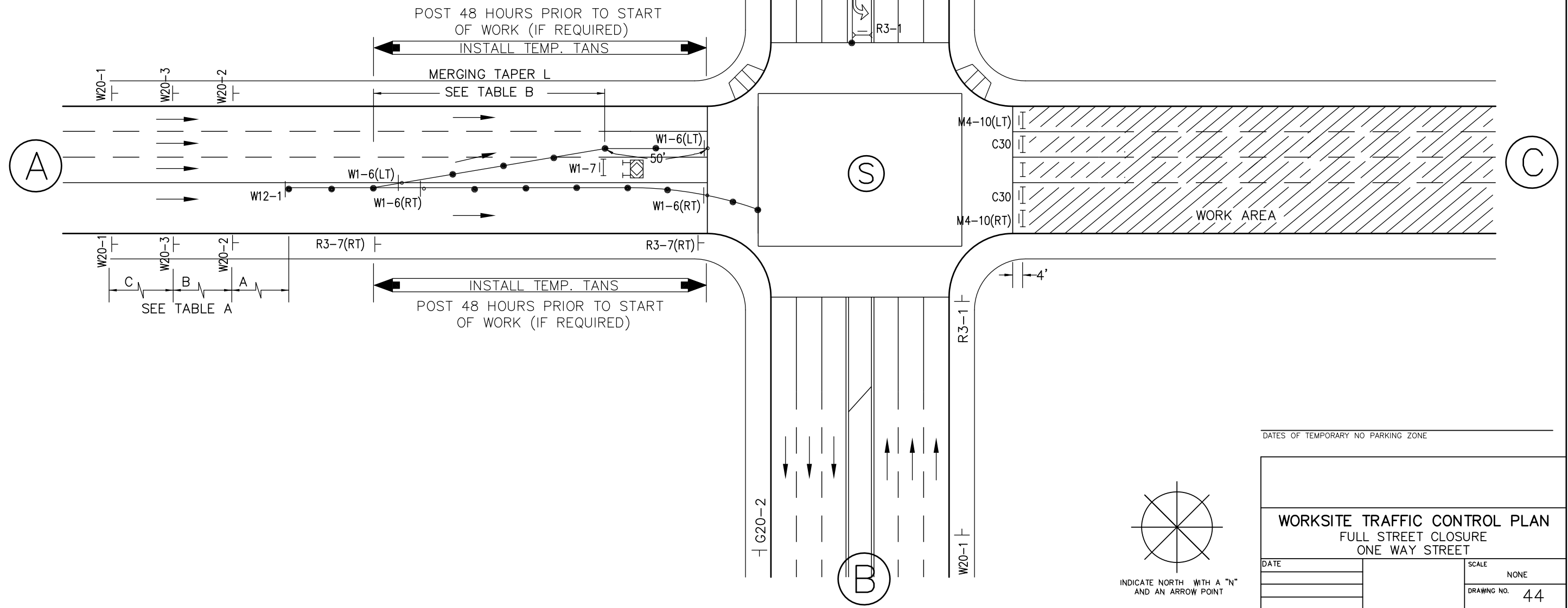

REV. APR-2010 CJUTCM-DWG44.DWG

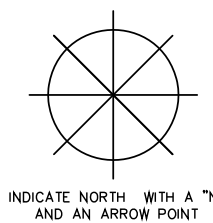

DATES OF TEMPORARY NO PARKING ZONE _____

WORKSITE TRAFFIC CONTROL PLAN		
FULL STREET CLOSURE		
ONE WAY STREET		
DATE		SCALE
		NONE
		DRAWING NO.
		44



CONSTRUCTION NOTE:
ALL DRIVEWAYS TO REMAIN OPEN (WHENEVER POSSIBLE) THROUGHOUT TRAFFIC CONTROL ZONE



SEE TABLE 'A'-'F' FOR SIGN AND CHANNELIZER DEVICE SPACING AND TAPER LENGTH

SPEED	APPROACH STREET	TAPER LENGTH	SIGN SPACING	CHANNELIZER SPACING

SEE TABLE 'A'-'F' FOR SIGN AND CHANNELIZER DEVICE SPACING AND TAPER LENGTH

SPEED	APPROACH STREET	TAPER LENGTH	SIGN SPACING	CHANNELIZER SPACING

ABBREVIATIONS:

- S = Sign Spacing
- Min = Minimum
- LT = Left
- RT = Right
- LTP = Lane Traffic Panel
- TANSAT = Tow Away, No Stopping Anytime
- TANS = Tow Away, No Stopping

— CHART A —
MINIMUM RECOMMENDED DELINEATOR/CONE & SIGN PLACEMENT

POSTED SPEED LIMIT	TAPER LENGTH FOR 12-FT LANE			CHANNELIZER SPACING		SIGN SPACING (ADVANCE OF TAPER & BETWEEN SIGNS)
	MERGING	SHIFTING	SHOULDER	TAPER	TANGENT	
20 MPH	80 FT.	40 FT.	27 FT.	20 FT.	40 FT.	100 FT.
25 MPH	125 FT.	63 FT.	42 FT.	25 FT.	63 FT.	100 FT.
30 MPH	180 FT.	90 FT.	60 FT.	30 FT.	90 FT.	350 FT.
35 MPH	245 FT.	123 FT.	82 FT.	35 FT.	123 FT.	350 FT.
40 MPH	320 FT.	160 FT.	107 FT.	40 FT.	160 FT.	350 FT.
* 45 MPH	540 FT.	270 FT.	180 FT.	45 FT.	270 FT.	500 FT.
* 50 MPH	600 FT.	300 FT.	200 FT.	50 FT.	300 FT.	500 FT.
* 55+MPH	660 FT.	330 FT.	220 FT.	55 FT.	330 FT.	PER TABLE 'A'

NOTES

1. A Flashing Arrow sign shall be used for each lane closed.
- *2. Two lane closure signs (C-20) shall be used on the approach to a lane closure with speeds of 45 mph or greater.

NOTE: This chart based on 12-foot wide lanes.

For lane widths greater than 12 feet, use the following formulae:

Taper formula:

$$L = S \times W \text{ for speeds of 45 mph or more.}$$

$$L = \frac{WS^2}{60} \text{ for speeds of 40 mph or less.}$$

Where:













L = Minimum length of taper.

S = Numerical value of posted speed limit prior to work or 85 percentile speed.

W = Width of offset.

i.e.: 50 mph and 19' lane; $L = 50 \times 19 = 950$ feet

LEGEND

-  TYPE III BARRICADE W/SIGN
-  TYPE II BARRICADE W/O SIGN
-  CHANNELIZING DEVICE
-  TRAFFIC CONE WITH CLIP ON SIGN
-  SIGN
-  SIGNALIZED INTERSECTION
-  ARROW PANEL (FLASHING ARROW) (WHERE REQUIRED)
-  HIGH LEVEL WARNING DEVICE (FLAGTREE) (OPTIONAL)
-  FLAGGER
- TANS TOW AWAY NO STOPPING ____ TO ____ (SHOW HOURS)
- TANSAT TOW AWAY NO STOPPING ANY TIME
-  WORK ZONE (ACTIVITY AREA) LIMITS
-  DIRECTION OF TRAFFIC (NOT PAVEMENT MARKING)
-  ROADWAY DESIGNATION (A THROUGH D)

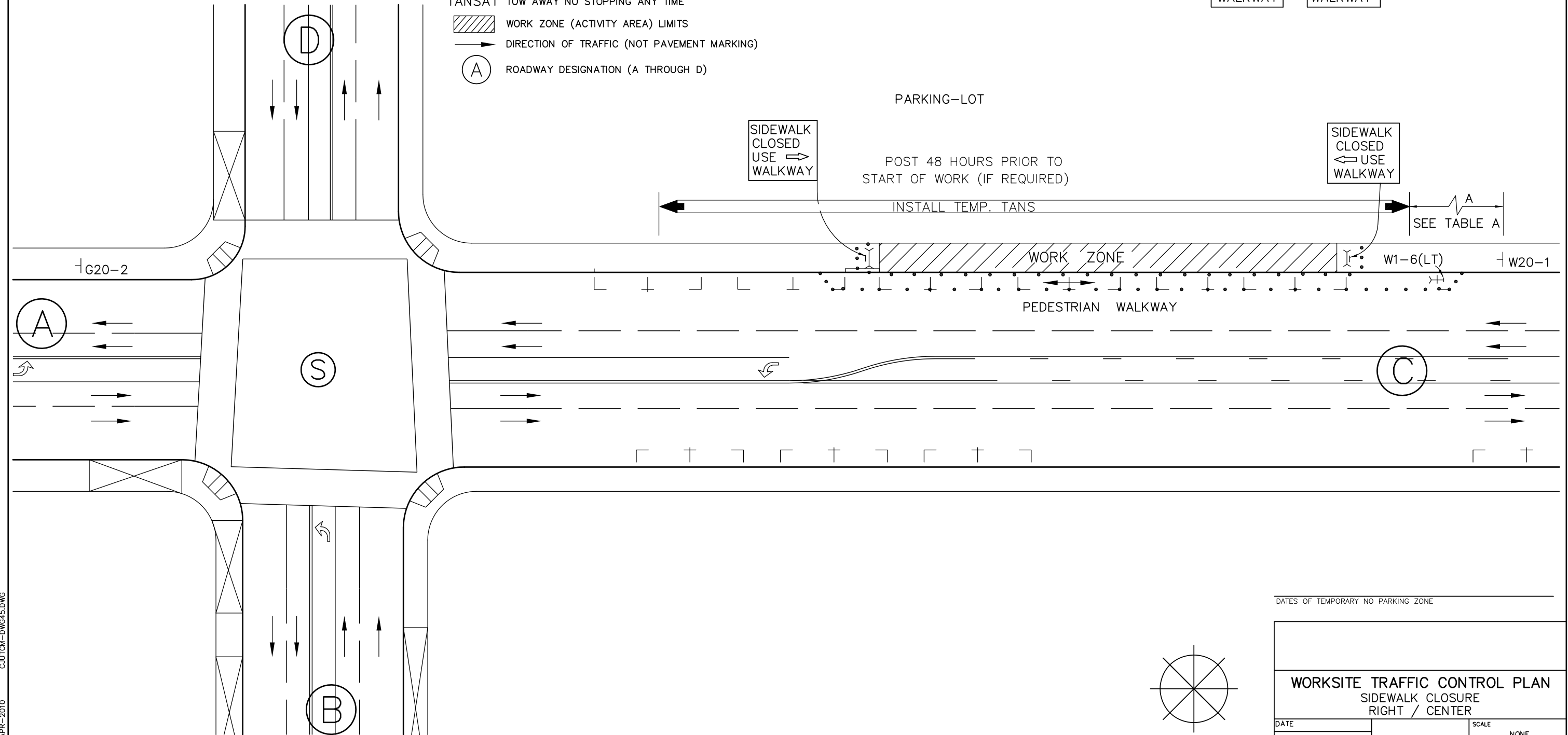
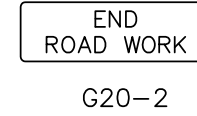
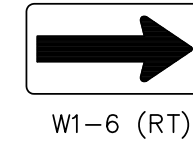
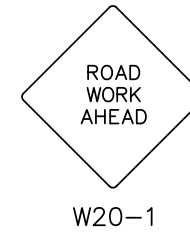
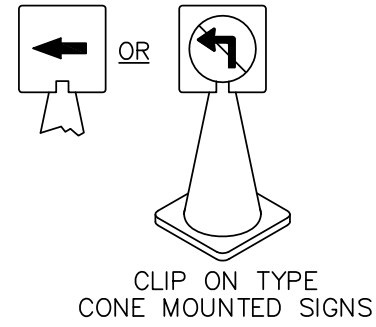

DATES OF TEMPORARY NO PARKING ZONE _____

WORKSITE TRAFFIC CONTROL PLAN		
SIDEWALK CLOSURE RIGHT / CENTER		
DATE		SCALE
		NONE
		DRAWING NO.
		45



CONSTRUCTION NOTE:
ALL DRIVEWAYS TO REMAIN OPEN (WHENEVER POSSIBLE) THROUGHOUT TRAFFIC CONTROL ZONE

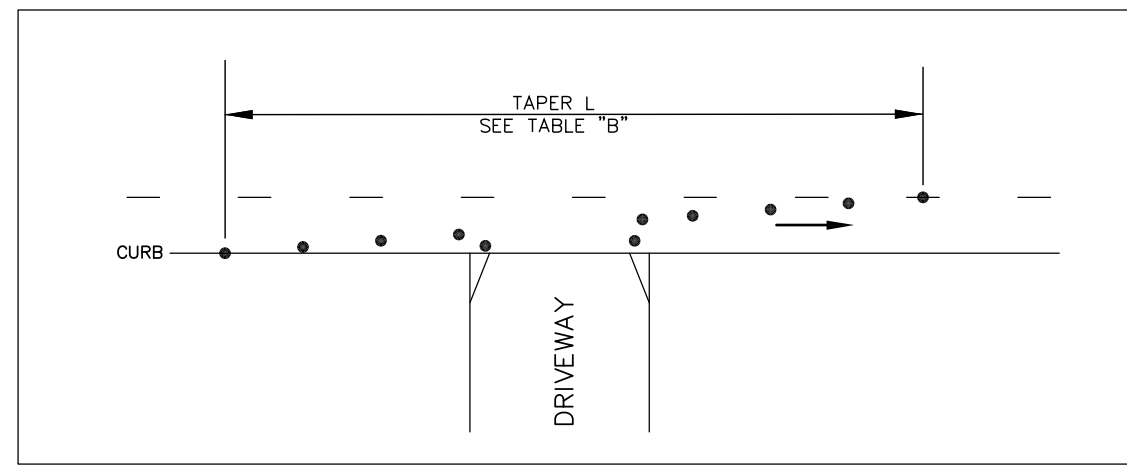

SEE TABLE 'A'-'F' FOR SIGN AND CHANNELIZER DEVICE SPACING AND TAPER LENGTH

SPEED	APPROACH STREET	TAPER LENGTH	SIGN SPACING	CHANNELIZER SPACING

SEE TABLE 'A'-'F' FOR SIGN AND CHANNELIZER DEVICE SPACING AND TAPER LENGTH

SPEED	APPROACH STREET	TAPER LENGTH	SIGN SPACING	CHANNELIZER SPACING

ABBREVIATIONS:

- S = Sign Spacing
- Min = Minimum
- LT = Left
- RT = Right
- LTP = Lane Traffic Panel
- TANSAT = Tow Away, No Stopping Anytime
- TANS = Tow Away, No Stopping

— CHART A —
MINIMUM RECOMMENDED DELINEATOR/CONE & SIGN PLACEMENT

POSTED SPEED LIMIT	TAPER LENGTH FOR 12-FT LANE			CHANNELIZER SPACING		SIGN SPACING (ADVANCE OF TAPER & BETWEEN SIGNS)
	MERGING	SHIFTING	SHOULDER	TAPER	TANGENT	
20 MPH	80 FT.	40 FT.	27 FT.	20 FT.	40 FT.	100 FT.
25 MPH	125 FT.	63 FT.	42 FT.	25 FT.	63 FT.	100 FT.
30 MPH	180 FT.	90 FT.	60 FT.	30 FT.	90 FT.	350 FT.
35 MPH	245 FT.	123 FT.	82 FT.	35 FT.	123 FT.	350 FT.
40 MPH	320 FT.	160 FT.	107 FT.	40 FT.	160 FT.	350 FT.
* 45 MPH	540 FT.	270 FT.	180 FT.	45 FT.	270 FT.	500 FT.
* 50 MPH	600 FT.	300 FT.	200 FT.	50 FT.	300 FT.	500 FT.
* 55+MPH	660 FT.	330 FT.	220 FT.	55 FT.	330 FT.	PER TABLE 'A'

NOTES

1. A Flashing Arrow sign shall be used for each lane closed.
- *2. Two lane closure signs (C-20) shall be used on the approach to a lane closure with speeds of 45 mph or greater.

NOTE: This chart based on 12-foot wide lanes.

For lane widths greater than 12 feet, use the following formulae:

Taper formula:

$$L = S \times W \text{ for speeds of 45 mph or more.}$$

$$L = \frac{WS^2}{60} \text{ for speeds of 40 mph or less.}$$

Where:

L = Minimum length of taper.

S = Numerical value of posted speed limit prior to work or 85 percentile speed.

W = Width of offset.

i.e.: 50 mph and 19' lane; $L = 50 \times 19 = 950$ feet

REV. APR-2010 C:\JUTCM-DWG46.DWG

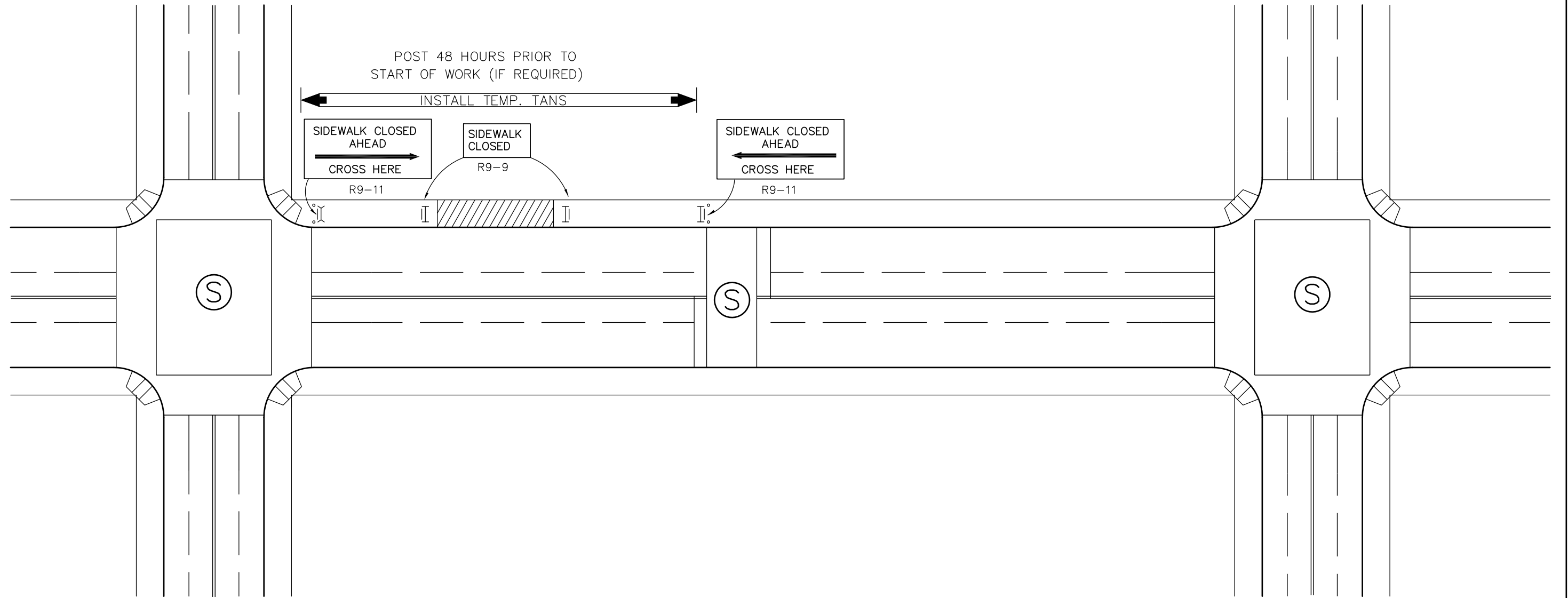

LEGEND

- TYPE III BARRICADE W/SIGN
- TYPE II BARRICADE W/O SIGN
- CHANNELIZING DEVICE
- TRAFFIC CONE WITH CLIP ON SIGN
- SIGN
- SIGNALIZED INTERSECTION
- ARROW PANEL (FLASHING ARROW) (WHERE REQUIRED)
- HIGH LEVEL WARNING DEVICE (FLAGTREE) (OPTIONAL)
- FLAGGER
- TANS TOW AWAY NO STOPPING ____ TO ____ (SHOW HOURS)
- TANSAT TOW AWAY NO STOPPING ANY TIME
- WORK ZONE (ACTIVITY AREA) LIMITS
- DIRECTION OF TRAFFIC (NOT PAVEMENT MARKING)
- ROADWAY DESIGNATION (A THROUGH D)

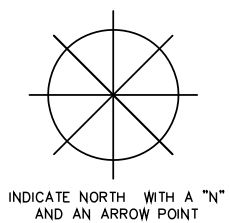
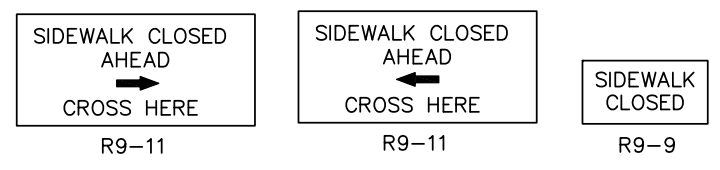

DATES OF TEMPORARY NO PARKING ZONE _____		
WORKSITE TRAFFIC CONTROL PLAN SIDEWALK CLOSURE		
DATE		SCALE
		NONE
		DRAWING NO. 46



CONSTRUCTION NOTE:
ALL DRIVEWAYS TO REMAIN OPEN (WHENEVER POSSIBLE) THROUGHOUT TRAFFIC CONTROL ZONE



SEE TABLE 'A'-'F' FOR SIGN AND CHANNELIZER DEVICE SPACING AND TAPER LENGTH

SPEED	APPROACH STREET	TAPER LENGTH	SIGN SPACING	CHANNELIZER SPACING

SEE TABLE 'A'-'F' FOR SIGN AND CHANNELIZER DEVICE SPACING AND TAPER LENGTH

SPEED	APPROACH STREET	TAPER LENGTH	SIGN SPACING	CHANNELIZER SPACING

ABBREVIATIONS:

- S = Sign Spacing
- Min = Minimum
- LT = Left
- RT = Right
- LTP = Lane Traffic Panel
- TANSAT = Tow Away, No Stopping Anytime
- TANS = Tow Away, No Stopping

— CHART A —
MINIMUM RECOMMENDED DELINEATOR/CONE & SIGN PLACEMENT

POSTED SPEED LIMIT	TAPER LENGTH FOR 12-FT LANE			CHANNELIZER SPACING		SIGN SPACING (ADVANCE OF TAPER & BETWEEN SIGNS)
	MERGING	SHIFTING	SHOULDER	TAPER	TANGENT	
20 MPH	80 FT.	40 FT.	27 FT.	20 FT.	40 FT.	100 FT.
25 MPH	125 FT.	63 FT.	42 FT.	25 FT.	63 FT.	100 FT.
30 MPH	180 FT.	90 FT.	60 FT.	30 FT.	90 FT.	350 FT.
35 MPH	245 FT.	123 FT.	82 FT.	35 FT.	123 FT.	350 FT.
40 MPH	320 FT.	160 FT.	107 FT.	40 FT.	160 FT.	350 FT.
* 45 MPH	540 FT.	270 FT.	180 FT.	45 FT.	270 FT.	500 FT.
* 50 MPH	600 FT.	300 FT.	200 FT.	50 FT.	300 FT.	500 FT.
* 55+MPH	660 FT.	330 FT.	220 FT.	55 FT.	330 FT.	PER TABLE 'A'

NOTES

1. A Flashing Arrow sign shall be used for each lane closed.
- *2. Two lane closure signs (C-20) shall be used on the approach to a lane closure with speeds of 45 mph or greater.

NOTE: This chart based on 12-foot wide lanes.

For lane widths greater than 12 feet, use the following formulae:

Taper formula:

$$L = S \times W \text{ for speeds of 45 mph or more.}$$

$$L = \frac{WS^2}{60} \text{ for speeds of 40 mph or less.}$$

Where:

L = Minimum length of taper.

S = Numerical value of posted speed limit prior to work or 85 percentile speed.

W = Width of offset.

i.e.: 50 mph and 19' lane; $L = 50 \times 19 = 950$ feet

REV. APR-2010 C:\JUTCM-DWG\47.DWG

POST 48 HOURS PRIOR TO
START OF WORK (IF REQUIRED)

INSTALL TEMP. TANS

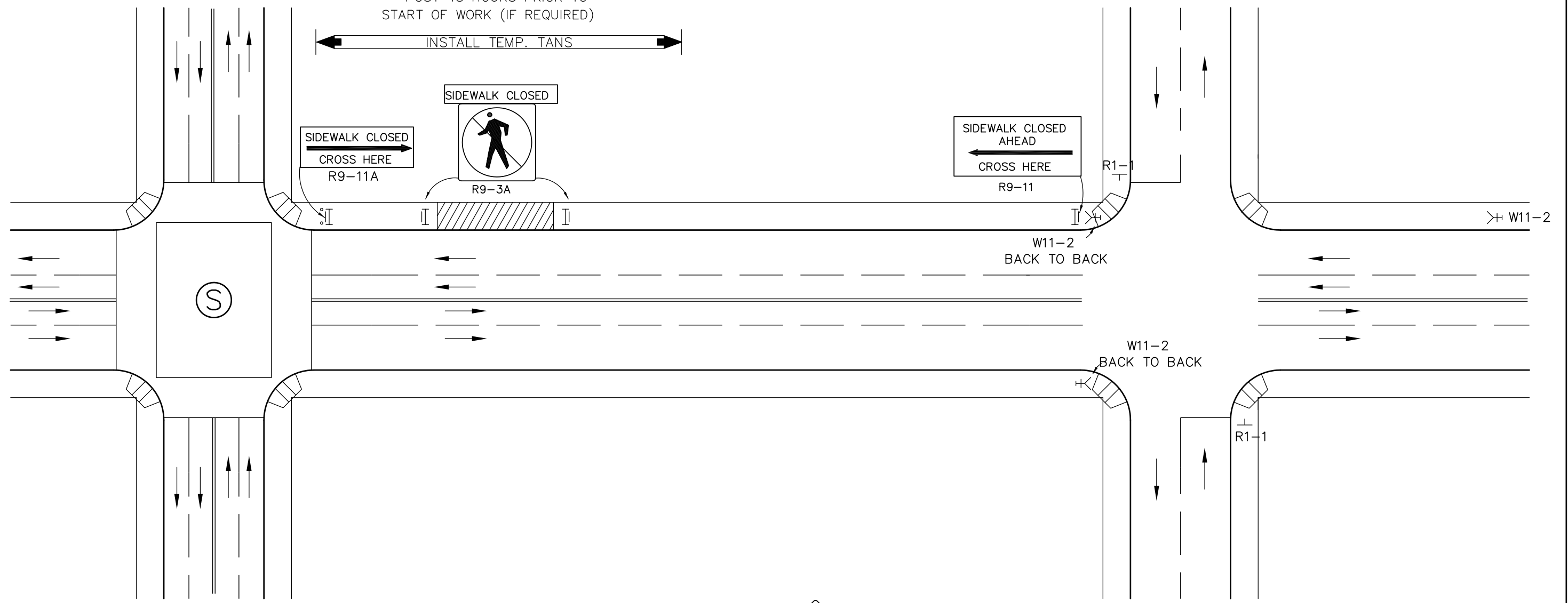

LEGEND

- TYPE III BARRICADE W/SIGN
- TYPE II BARRICADE W/O SIGN
- CHANNELIZING DEVICE
- TRAFFIC CONE WITH CLIP ON SIGN
- SIGN
- SIGNALIZED INTERSECTION
- ARROW PANEL (FLASHING ARROW) (WHERE REQUIRED)
- HIGH LEVEL WARNING DEVICE (FLAGTREE) (OPTIONAL)
- FLAGGER
- TANS** TOW AWAY NO STOPPING ____ TO ____ (SHOW HOURS)
- TANSAT** TOW AWAY NO STOPPING ANY TIME
- WORK ZONE (ACTIVITY AREA) LIMITS
- DIRECTION OF TRAFFIC (NOT PAVEMENT MARKING)
- ROADWAY DESIGNATION (A THROUGH D)

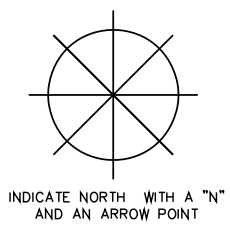
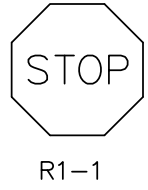
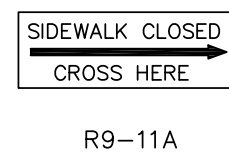
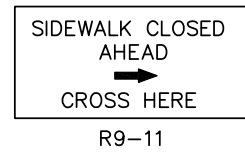

DATES OF TEMPORARY NO PARKING ZONE _____		
WORKSITE TRAFFIC CONTROL PLAN SIDEWALK CLOSURE		
DATE		SCALE
		NONE
		DRAWING NO. 47



CONSTRUCTION NOTE:
 ALL DRIVEWAYS TO REMAIN OPEN (WHENEVER POSSIBLE) THROUGHOUT TRAFFIC CONTROL ZONE



SEE TABLE 'A'-'F' FOR SIGN AND CHANNELIZER DEVICE SPACING AND TAPER LENGTH

SPEED	APPROACH STREET	TAPER LENGTH	SIGN SPACING	CHANNELIZER SPACING

SEE TABLE 'A'-'F' FOR SIGN AND CHANNELIZER DEVICE SPACING AND TAPER LENGTH

SPEED	APPROACH STREET	TAPER LENGTH	SIGN SPACING	CHANNELIZER SPACING

ABBREVIATIONS:

- S = Sign Spacing
- Min = Minimum
- LT = Left
- RT = Right
- LTP = Lane Traffic Panel
- TANSAT = Tow Away, No Stopping Anytime
- TANS = Tow Away, No Stopping

— CHART A —
 MINIMUM RECOMMENDED DELINEATOR/CONE & SIGN PLACEMENT

POSTED SPEED LIMIT	TAPER LENGTH FOR 12-FT LANE			CHANNELIZER SPACING		SIGN SPACING (ADVANCE OF TAPER & BETWEEN SIGNS)
	MERGING	SHIFTING	SHOULDER	TAPER	TANGENT	
20 MPH	80 FT.	40 FT.	27 FT.	20 FT.	40 FT.	100 FT.
25 MPH	125 FT.	63 FT.	42 FT.	25 FT.	63 FT.	100 FT.
30 MPH	180 FT.	90 FT.	60 FT.	30 FT.	90 FT.	350 FT.
35 MPH	245 FT.	123 FT.	82 FT.	35 FT.	123 FT.	350 FT.
40 MPH	320 FT.	160 FT.	107 FT.	40 FT.	160 FT.	350 FT.
* 45 MPH	540 FT.	270 FT.	180 FT.	45 FT.	270 FT.	500 FT.
* 50 MPH	600 FT.	300 FT.	200 FT.	50 FT.	300 FT.	500 FT.
* 55+MPH	660 FT.	330 FT.	220 FT.	55 FT.	330 FT.	PER TABLE 'A'

NOTES

1. A Flashing Arrow sign shall be used for each lane closed.
- *2. Two lane closure signs (C-20) shall be used on the approach to a lane closure with speeds of 45 mph or greater.

NOTE: This chart based on 12-foot wide lanes.

For lane widths greater than 12 feet, use the following formulae:

Taper formula:

$$L = S \times W \text{ for speeds of 45 mph or more.}$$

$$L = \frac{WS^2}{60} \text{ for speeds of 40 mph or less.}$$

Where:

L = Minimum length of taper.

S = Numerical value of posted speed limit prior to work or 85 percentile speed.

W = Width of offset.

i.e.: 50 mph and 19' lane; $L = 50 \times 19 = 950$ feet

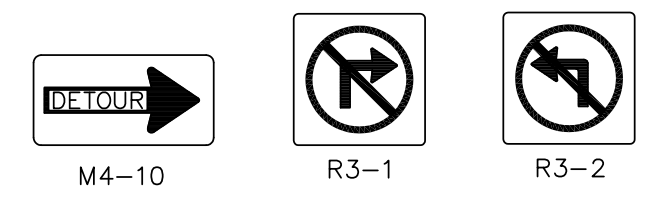
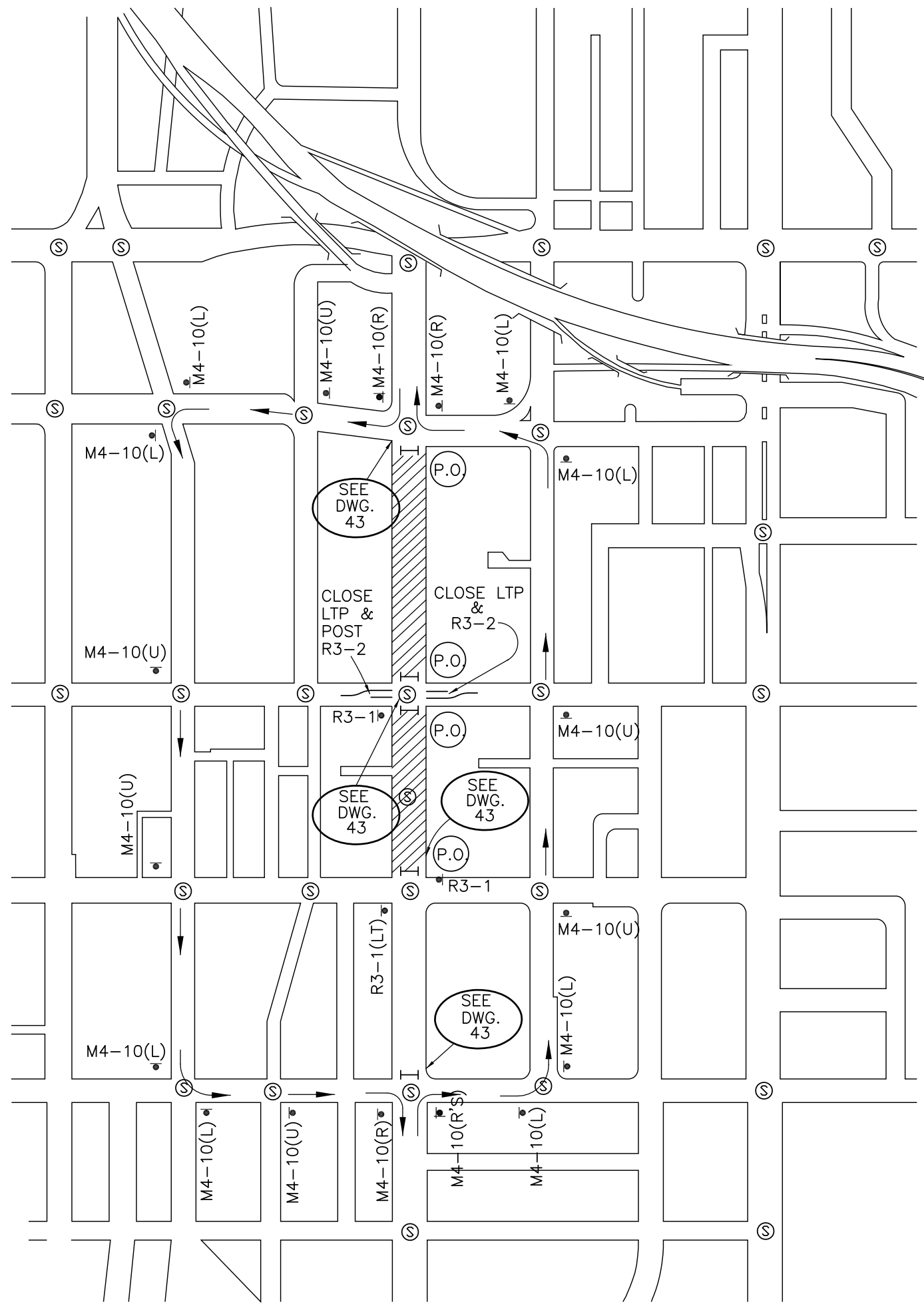

LEGEND
 P.O. - POLICE OFFICER
 M4-10 - DETOUR (L-LEFT, R-RIGHT, U-UP)
 — DIRECTION OF DETOUR
 S - TRAFFIC SIGNAL

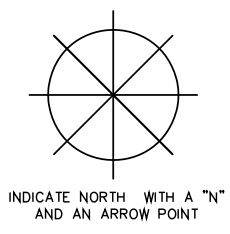

DATES OF TEMPORARY NO PARKING ZONE

WORKSITE TRAFFIC CONTROL PLAN SAMPLE TRAFFIC CIRCULATION PLAN		
DATE		SCALE
		NONE
		DRAWING NO.
		48



CONSTRUCTION NOTE:
ALL DRIVEWAYS TO REMAIN OPEN (WHENEVER POSSIBLE) THROUGHOUT TRAFFIC CONTROL ZONE



SEE TABLE 'A'-'F' FOR SIGN AND CHANNELIZER DEVICE SPACING AND TAPER LENGTH

SPEED	APPROACH STREET	TAPER LENGTH	SIGN SPACING	CHANNELIZER SPACING

SEE TABLE 'A'-'F' FOR SIGN AND CHANNELIZER DEVICE SPACING AND TAPER LENGTH

SPEED	APPROACH STREET	TAPER LENGTH	SIGN SPACING	CHANNELIZER SPACING

ABBREVIATIONS:

- S = Sign Spacing
- Min = Minimum
- LT = Left
- RT = Right
- LTP = Lane Traffic Panel
- TANSAT = Tow Away, No Stopping Anytime
- TANS = Tow Away, No Stopping

— CHART A —
MINIMUM RECOMMENDED DELINEATOR/CONE & SIGN PLACEMENT

POSTED SPEED LIMIT	TAPER LENGTH FOR 12-FT LANE			CHANNELIZER SPACING		SIGN SPACING (ADVANCE OF TAPER & BETWEEN SIGNS)
	MERGING	SHIFTING	SHOULDER	TAPER	TANGENT	
20 MPH	80 FT.	40 FT.	27 FT.	20 FT.	40 FT.	100 FT.
25 MPH	125 FT.	63 FT.	42 FT.	25 FT.	63 FT.	100 FT.
30 MPH	180 FT.	90 FT.	60 FT.	30 FT.	90 FT.	350 FT.
35 MPH	245 FT.	123 FT.	82 FT.	35 FT.	123 FT.	350 FT.
40 MPH	320 FT.	160 FT.	107 FT.	40 FT.	160 FT.	350 FT.
* 45 MPH	540 FT.	270 FT.	180 FT.	45 FT.	270 FT.	500 FT.
* 50 MPH	600 FT.	300 FT.	200 FT.	50 FT.	300 FT.	500 FT.
* 55+MPH	660 FT.	330 FT.	220 FT.	55 FT.	330 FT.	PER TABLE 'A'

NOTES

1. A Flashing Arrow sign shall be used for each lane closed.
- *2. Two lane closure signs (C-20) shall be used on the approach to a lane closure with speeds of 45 mph or greater.

NOTE: This chart based on 12-foot wide lanes.

For lane widths greater than 12 feet, use the following formulae:

Taper formula:

$$L = S \times W \text{ for speeds of 45 mph or more.}$$

$$L = \frac{WS^2}{60} \text{ for speeds of 40 mph or less.}$$

Where:

L = Minimum length of taper.

S = Numerical value of posted speed limit prior to work or 85 percentile speed.

W = Width of offset.

i.e.: 50 mph and 19' lane; $L = 50 \times 19 = 950$ feet

Southern California Edison
ELM Project A.18-05-007

DATA REQUEST SET A1805007-ED-SCE-DEF-001

To: ENERGY DIVISION
Prepared by: Selya Arce
Title: Sr. Project Manager
Dated: 07/17/2018

Question 54 (B-30):

Provide a preliminary description of the traffic management plan that would be implemented during construction of the Proposed Project

This is not provided.

A. Please provide a preliminary description of the traffic management plan. It is recognized that details will be forthcoming during pre-construction plan review. Also, briefly describe the use of traffic control for temporary road closures during helicopter external load overflights of frequently used roadways (e.g. Interstate and local highways).

Response to Question 54 (B-30):

Traffic control measures for this project will be employed for locations where the work areas encroach upon a publicly traveled right-of-way. Traffic control measures will be specified in the traffic control plans for each of these locations. The traffic control plans will be developed using the California Manual on Uniform Traffic Control Devices (MUTCD), the California Joint Utility Traffic Control Manual, or the Federal Highway Administration (FHWA) MUTCD, as applicable to the state of California or the state of Nevada and approved by the local or state agency. A preliminary Traffic Management Plan is attached. Final plans will be submitted (60) days prior to start of construction.

As safety of the traveling public is paramount, maintenance of adequate levels of traffic control shall be minded for all work, for all circumstances. This may require utilization of specialty subcontractors with thorough working knowledge of all the applicable laws, standards, means and methods to provide the safest environment for the traveling public.

The measures to be employed to maintain this objective will vary by work and circumstance, but will include the following at a minimum:

- Controlling the flow of traffic near a work zone through the use of flaggers, signs, cones, and/or other positive directional devices to keep the public safe and to reduce speed of vehicles in the area

- Routing pedestrians along a safe, usable, same-side path of travel that is: (a) adjacent to the worksite along widened and unblocked sidewalk surfaces, or (b) along adjacent landscaping within the right-of-way, or (c) along closed bike lanes, or (d) along parallel parking areas
- Routing pedestrians across the street to a sidewalk, around and away from the area of work

For helicopter use, additional measures will be employed to ensure the safety of the traveling public:

- Ferrying materials and equipment over roads and other major crossings will be avoided, as possible
- Access roads will only be crossed when absent of any traffic
- Additionally, SCE would comply with APM-NOI-01 : Duration of Helicopter Use and APM-NOI-02: Helicopter Use in Residential Areas

Attachment: ELM Q# 54 California Joint Utility Traffic Control Manual

Southern California Edison
ELM Project A.18-05-007

DATA REQUEST SET A1805007-ED-SCE-DEF-001

To: ENERGY DIVISION
Prepared by: Rey Gonzales
Title: Environmental Project Manager
Dated: 07/17/2018

Question 55 (B-34):

Excel spreadsheet that includes all parcels within 300 feet of any project component with the following data: APN number, owner mailing address, and parcels physical address. [Note: notice of all property owners within 300 feet is required under GO 131-D.]

A hard copy is in SCE's Application and in PEA Chapter 6 (Other Process- Related Data Needs). But no Excel spreadsheet was provided.

A. Please provide an excel file with the required information.

Response to Question 55 (B-34):

An Excel spreadsheet containing the data presented in Table 6-1: Mailing List – Properties Within 300 Feet is attached for your convenience.