

POWER LINE FIRE PREVENTION FIELD GUIDE

2001 Edition



Power Line Fire Prevention Field Guide

March 27, 2001

*Gray Davis
Governor
State of California*

*Mary D. Nichols
Secretary for Resources
The Resources Agency*

*Andrea E. Tuttle
Director
Department of Forestry and Fire Protection*

*John Tennant
State Fire Marshal
Department of Forestry and Fire Protection*

Contents

Section 1

Foreword.....	1-1
1. Introduction.....	1-2
2. Electric Power.....	1-3
2.1 Generation.....	1-3
2.2 Transmission.....	1-3
2.3 Distribution.....	1-3
3. Fire Hazard.....	1-5
4. Utility Pole/Tower Vegetation Clearance.....	1-5
5. Conductor Clearances.....	1-5
6. Exemptions.....	1-6
7. Special Concerns.....	1-7
8. Training.....	1-8
9. Exemption Policy.....	1-10
9.1 Exemption Procedures.....	1-10
10. Inspection Policy.....	1-11
10.1 Utility Company Inspections.....	1-11
10.2 Fire Protection Agency Inspections.....	1-12
10.3 Joint Inspections.....	1-13
10.4 Ground Inspections.....	1-13
10.5 Aerial Inspections.....	1-13
11. Location Identification.....	1-14
12. Hazardous Tree Identification.....	1-18
12.1 Recognizing Potential Root Defects.....	1-18
13. Root Defects and Leaning Trees.....	1-18
13.1 Recognizing Heart Rot.....	1-18
13.2 Degree of Hazard from Heart Rot or Butt Rot.....	1-19
14. Trunk Deformities.....	1-19
14.1 Dwarf Mistletoe Cankers.....	1-19
14.2 Man Caused Deformities.....	1-19
14.3 Combination Defects.....	1-20
15. Defective Limbs.....	1-20
15.1 Size of Limbs.....	1-20
15.2 Location of Limbs.....	1-20
15.3 Relative Durability of Wood.....	1-20
15.4 Weather Conditions.....	1-21
15.5 Guidelines for Dead Limb Hazard Control.....	1-21
16. Top Defects.....	1-21
16.1 Dead Tops.....	1-21
16.2 Broken Out Tops and Volunteer Tops.....	1-21
17. Other Crown Conditions.....	1-22
17.1 Thick Growth.....	1-22
17.2 Structure.....	1-22
18. Techniques and Aids.....	1-22

Statutes and Regulations	1-23
Section 4021.....	1-23
Section 4101.....	1-23
Section 4117.....	1-23
Section 4119.....	1-23
Section 4125.....	1-23
Section 4126.....	1-24
Section 4127.....	1-24
Section 4128.....	1-24
Section 4171.....	1-24
Section 4290.....	1-25
Section 4291.....	1-25
Section 4292.....	1-26
Section 4293.....	1-27
Section 4294.....	1-27
Section 4295.....	1-27
Section 4296.....	1-28
Section 4435.....	1-28
Health and Safety Code	1-29
Section 13001.....	1-29
Section 13007.....	1-29
Section 13009.....	1-29
Section 13009.1.....	1-30
Section 13009.5.....	1-30
Title 14, California Code of Regulations	1-31
Section 1250.....	1-31
Section 1251.....	1-31
Section 1252.....	1-31
Section 1252.1.....	1-32
Section 1252.2.....	1-32
Section 1252.3.....	1-32
Section 1253.....	1-32
Section 1254.....	1-32
Section 1255.....	1-33
Section 1256.....	1-34
Section 1257.....	1-34
Section 1258.....	1-34
General Order No. 95, (Public Utilities Commission).....	1-40
Code of Federal Regulations.....	1-40
Section 261 - Prohibitions.....	1-40
Section 261.10.....	1-40
Section 261.50.....	1-40
Section 261.52.....	1-41
Local Ordinances	1-41
Terms and Conditions of Permits and Easements.....	1-41

Section 2 – Non-Exempt

Section 3 – Exempt

Section 4 – Construction

Section 5 – Bulletins/Correspondence

Section 6 – List of Figures/Glossary of Terms

List of Photographs and Figures6-1
Glossary of Terms.....6-4

Section 1

Foreword

This Guide contains standards necessary to minimize wildland fires that may be caused by the operation and maintenance of electrical power lines. These standards are based upon the studies and experiences of fire agencies and power line operations personnel, as well as on federal regulations and the laws of the State of California. These standards are to be considered minimum guides. Field conditions may indicate the need for efforts beyond these minimums.

Except for sample copies retained for historical or reference purposes, all copies of prior editions should be withdrawn from circulation and destroyed. Moreover, regardless of the inferences that any reader may draw from any statement in this Guide, the law must be obeyed. Thus, if there is any conflict between any statement in this Guide and any applicable statute, regulation or order, the statute, regulation or order shall take precedence. Some of the applicable statutes and regulations are set forth in STATUTES AND REGULATIONS section of this Guide.

It is expected that all personnel who make condition inspections and surveys, inspections of power lines, or who prescribe hazard reduction work or other fire prevention measures will be thoroughly familiar with the contents of this Guide. They should use it, refer to it regularly and observe the principles and practices included herein.

This Guide was developed as a mutual undertaking by the California Department of Forestry and Fire Protection, the Pacific Gas and Electric Company, the Southern California Edison Company and the other electric utilities of California. Its purpose is to provide information to the personnel of the fire service agencies and electrical operators for minimum uniform application within the areas of their respective jurisdiction and franchise responsibilities. The Guide is not to be used as a substitute for proper training, but as a reference for personnel already familiar with the subject.

This edition of the Guide has been substantially revised not only to reflect changes in laws, regulations, policy and technology, but also to enhance its usefulness as a working field tool. This guide is not intended to dictate to electrical utilities the methods which they must use to construct their facilities. However, the guide does detail fire hazard reduction maintenance procedures for conductors and for certain items of hardware.

1.1. Introduction

It is our intent that this edition of the Power Line Fire Prevention Field Guide will continue the partnership between fire agencies and the electric utilities. By working together and sharing expertise, technology, communications, training and data gathering, we can enter a new era of fire prevention and savings to the taxpayers and shareholders, both in dollars and in the valuable California environment.

Partnership Projects should consist of ideas and projects which further both fire prevention and economic efficiency as well as savings for the electric utilities.

Of the most vital importance is communication between the fire agencies and the electric utilities. We must take the utmost advantage of the current communication technology available to us. We need to establish an electronic mail and bulletin board system in which all parties can freely and formally communicate. The fire agencies need to provide immediate notification to the electric utilities when fires involve their property and equipment. The electric utilities need to notify the fire agencies when their equipment or hardware cause fires unknown to the fire agencies. Critical to the prevention of fires caused by electrical power is knowing when and where they occur and building this information into a GIS database which is shared by the fire agencies and electric utilities for future models and projects.

Currently, electric utilities are making an effort to inventory and map their power lines, power poles, hardware and equipment in a GPS and GIS system database. Performance and statistical data can be used to monitor exempt and non-exempt hardware both inside and outside the established fire hazard severity zones.

An expansive database can be used to focus and monitor vegetation management and maintenance in the fire hazard severity zones. Tree inventories can be beneficial to both the fire protection agencies and the electric utilities in both planning and maintenance situations.

Power line maintenance and construction can become a part of the Fire Protection Planning process in the construction of residential settings in the Wildland/Urban interface areas which are constantly expanding and growing.

Working together with the local electric utility representatives in training programs, inspection programs, maintenance programs, mapping projects and fire protection planning, is an investment of time and money which will ultimately save time, money and the valuable natural resources of California for future generations.

2. Electric Power

Electricity differs from other products because it is manufactured and used at the same instant. However there are similarities between it and other manufactured goods. First, a factory is required for production. For electricity this is the generating station. Second, the product must be transported in bulk to a distribution center. This is accomplished by use of high-voltage transmission lines. Third, from the distribution center, the product must be placed in the hands of the customer. Electricity makes its final journey to the customer over distribution lines.

2.1 Generation

At the present time, there are only two practical methods for manufacturing electricity in the large quantities needed to supply an area such as California. They are hydro-electric generation, which utilizes falling water as a means of turning a turbine generator, and steam generation, which requires a fuel to convert water to steam, which in turn drives a turbine generator.

The voltage at which electricity is generated varies depending on the installation. This voltage is then boosted by step-up transformers at the generating plant to the high voltage required for transmission over long distances.

2.2 Transmission

The transmission voltages in common use are 50 kV to 500 kV. It is then transmitted over tower lines to centrally located transmission and distribution substations.

2.3 Distribution

Distribution voltages commonly in use are 2.4 kV to 35 kV. Distribution circuits supply transformers which reduce the voltage so that it can be utilized by the customer. The secondary voltages which are normally supplied to the customer are 120 volts to 480 volts.

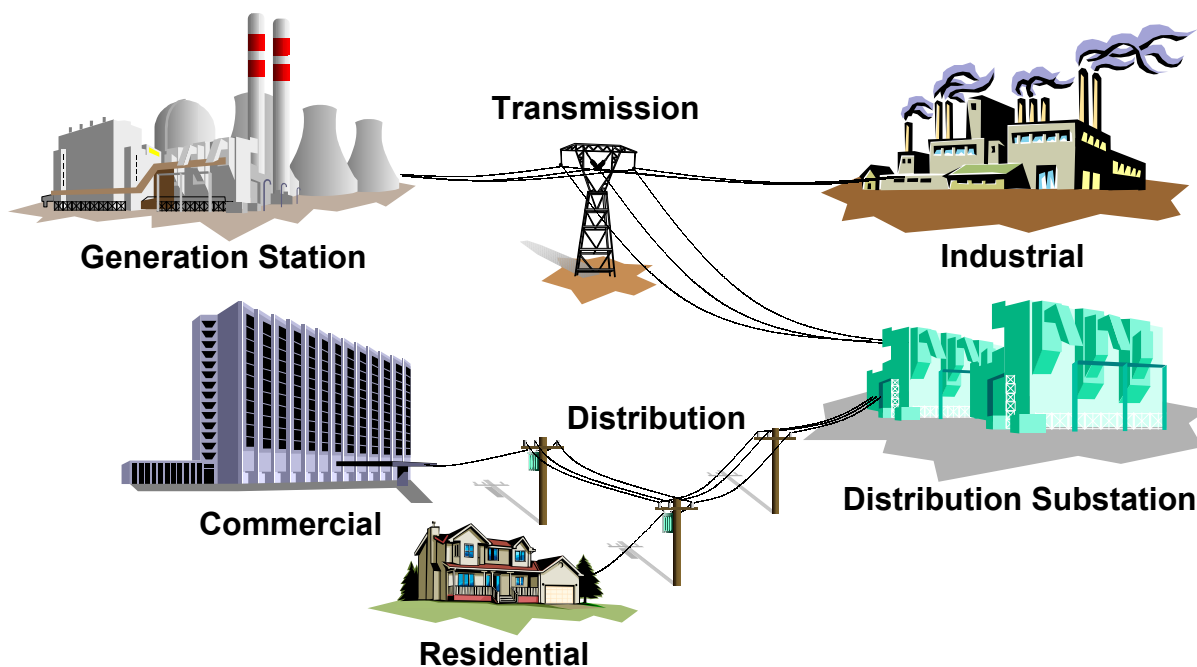
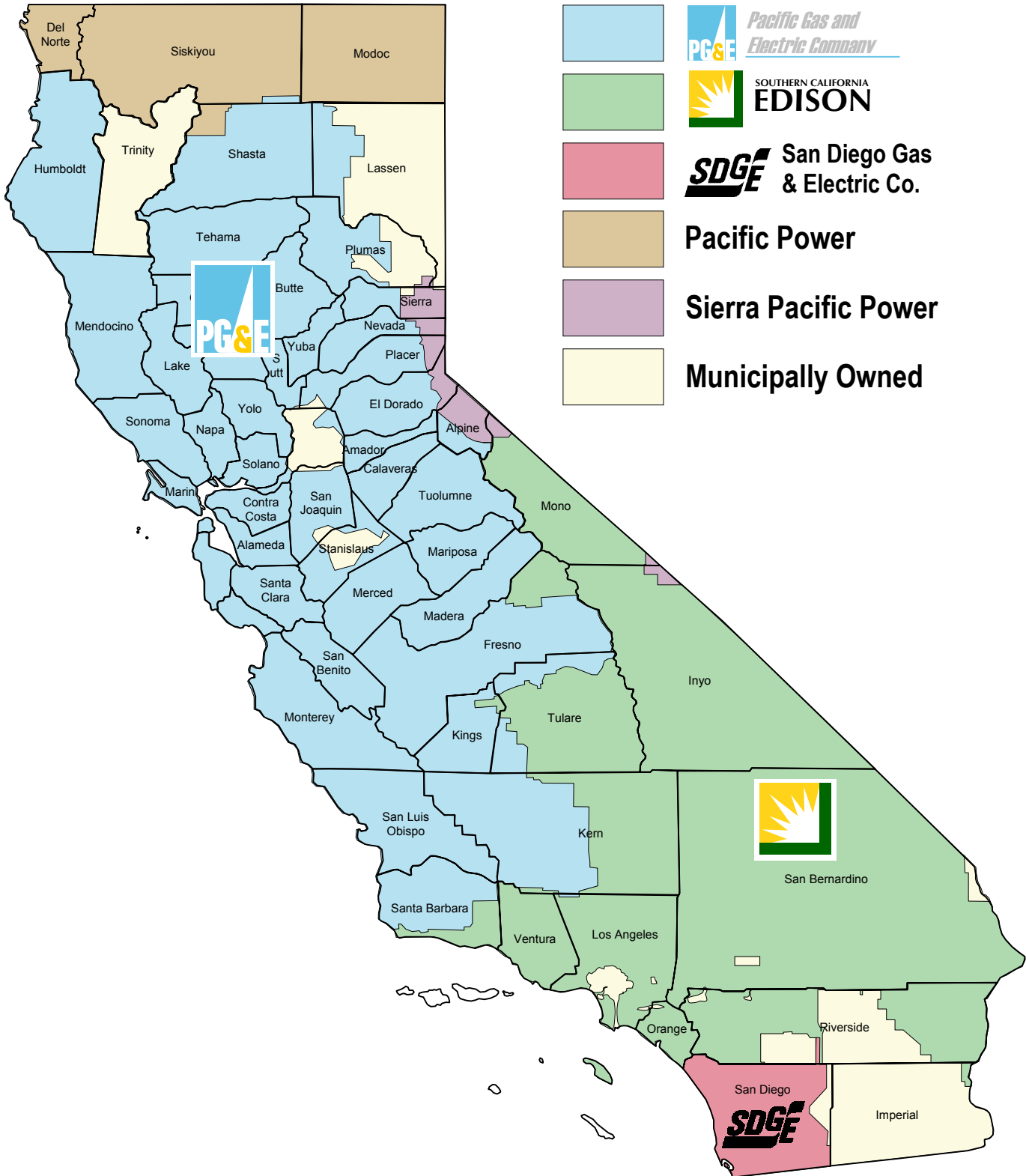

Figure 1 Major California Utility Companies



3. Fire Hazard

Electrical power presents an unusual hazard which brings about a mutual concern on the part of fire protection agencies and the electric utilities for making the transmission and distribution of electrical power as fire safe as possible. Fire protection agencies in their regulatory roles are concerned with public safety, loss and damage to natural resources and watershed as well as the costs of fire suppression. The electric utilities, both publicly and privately owned, are concerned with minimizing potential electrical fire hazards and minimizing interruptions of service to their customers.

This mutual concern has led to the creation of several editions of this Guide and now, to this revision. This Guide will be useful to, and used by, utility employees and the fire and resource protection agencies.

The potential exists that power line caused fires will become conflagrations during the long, hot and dry fire season commonly experienced in California. The very same weather conditions that contribute to power line faults also lead and contribute to the rapid spread of wildfire. The most critical of these weather factors is high wind, which is commonly accompanied by high temperatures and low humidity.

High, gusty winds may cause vegetation to sway into power lines, break off limbs or fall into power lines. High winds may also create vibrations in power lines that can lead to stress failures or cause loose connections to separate. Arcing usually accompanies such faults. Automatic reclosers re-energizing the line into the fault may cause repeated arcing and increase the probability of igniting vegetation.

4. Utility Pole/Tower Vegetation Clearance

The basic requirement for clearances around poles and towers is contained in Section 4292, of the California Public Resources Code (PRC). This section requires clearing of flammable fuels for a 10 foot radius from the outer circumference of certain poles and towers (non-exempt or subject poles or towers). Clearance requirements are based on the type of hardware affixed to the line at the pole or tower. The distances for clearance requirements must be measured horizontally, not along the surface of sloping ground.

For the specific procedures and requirements for compliance with Section 4292 of the Public Resources Code, see the Statutes and Regulations Section of this Guide.

5. Conductor Clearances

The basic requirements for clearances around electrical conductors are set forth in Section 4293, of the California Public Resources Code (PRC). This section requires clearance of all vegetation for a specific radial distance from conductors, based on the voltage carried by the conductors: four feet for voltages between 2,400 volts and 72,000 volts; six feet between 72,000 volts and 110,000 volts; and ten feet over 110,000 volts.

In addition this section requires the removal or trimming of trees, or portions of trees, that are dead, decadent, rotten, decayed or diseased and which may fall into or onto the line and trees leaning toward the line.

Although not required by law, a good safe practice, as reflected in many easements and use permits as well as the internal policies of several utilities, calls for a two foot radial clearance of all vegetation around any unprotected (without insulation) conductors energized at less than 2400 volts. The basic required clearances are considered minimum standards and often should be

exceeded. Some company policies require considerably more clearance as a general rule or in special situations, such as unusually long spans in high wind areas. This is especially true where the line is passing through an area of rapidly growing vegetation.

In many cases, the utility right-of-way or easement is considered the primary fire break by the fire agencies. The stacking or accumulation of debris resulting from tree trimming or removal operations should be avoided on these fire breaks. When these conditions exist, the debris should be chipped and scattered, avoiding the possibility of compromising the fire break.

6. Exemptions

Exemptions to the conductor clearance requirements are contained in Sections 4292, 4294, 4295 and 4296, PRC. Section 4293 authorizes other exemptions by administrative regulation. Exemptions are found in Title 14, Section 1257, California Code of Regulations.

The first exemption is in PRC Section 4292, which states that any line used exclusively as a communications circuit and so classed by the Public Utilities Commission, is exempt from the pole or tower clearance requirement. Railroad circuits, for instance, are used primarily for communication purposes but also provide power, more than 750 volts to operate track switches, and thus are not exempt.

Section 4292, PRC also authorizes the Director of Forestry and Fire Protection, and certain others, to make exceptions. Exceptions are contained in Section 1255, Title 14, Code of Regulations (CCR). These exceptions concern installed hardware and ground cover.

Section 4295 PRC recognizes private property rights by not requiring trespass if that is the only way in which clearance requirements can be maintained. It is not, however, intended as a loophole. Utilities are expected to make reasonable effort to secure permission to make the clearances and, if unsuccessful, to report their problem to the responsible fire protection agency. The agency can then attempt to persuade the property owner to allow the clearing.

Section 4296, PRC exempts lines carrying voltages of 750 volts or less. It has been found, however, that such lines, which are not insulated, can start fires. It is therefore considered good practice to maintain some clearance on these lines.

Section 1255, Title 14, exempts poles or towers where the conductors are continuous, or if not continuous, where they are joined by automatic, compression, copper or aluminum parallel groove connectors (i.e. Figures 3-20, 3-46 and 3-47). Automatic connectors are non-exempt if installed on jumper or other slack wires since they will not hold except under tension. Hot line tap or clamp connectors are exempt only if they are designed to absorb any expansion or contraction by applying spring tension on conductors (Figure 3-35). This section also exempts completely sealed and liquid filled equipment (Figures 3-6 through 3-11). Plate connectors are exempt, provided they are held together by two or more bolts (Figure 3-43). Solid blade, single-phase bypass switches and solid blade, single phase disconnect switches associated with circuit reclosers, sectionalizers and line regulators and Fargo FA 300 series piercing connectors when used with tree wire, are exempt. (Figures 3-36, 3-37).

The exemptions in Section 1255, Title 14, are related to the vegetation growing around the pole or tower. The subsections relate to essentially nonflammable vegetation that will not propagate fire. Subsection "c" covers vegetation maintained for the specific purpose of soil erosion and fire prevention. This is not intended as a loophole. The key words are "specific purpose", and they require a positive demonstration of this purpose in order to qualify.

7. Special Concerns

Legal considerations aside, special circumstances can exist that require additional hazard reduction measures in order to prevent fires or the liability that might arise from them.

Large birds and raptors are a fairly common hazard causing the need for special measures, as they frequently develop a liking for a particular pole or tower as a roosting place. Two fire prevention problems arise from this situation. First, their droppings build up on insulators to the extent that the potential exists for a flash-over between conductors and the crossarm. This situation can cause a line fault and the potential for glowing debris to fall from the pole to the ground. Secondly, during take-off or landing, their wings can touch two conductors simultaneously and create a short circuit. This situation can cause the bird to fall to the ground and ignite dry vegetation below the conductor. When such poles or towers are discovered, the ground should be cleared of all vegetation around them as a fire prevention measure. During inspections, an LE-38, LE-38A or USFS 5100-209 should be written, as advisory only, should these conditions be found. These situations may also be remedied with the installation of raptor construction (Figures 4-15 through 4-19).

Similar problems have been found and exist involving small birds and climbing animals resting on transformers. Some utilities use a plastic wildlife protection boot over one bushing of the transformer to prevent birds and animals from causing a direct short-circuit between the transformer bushings. Again, an advisory LE-38 should be written when these conditions are found.

Other conditions that may lead to potential fire problems are damaged hardware, damaged insulators, weather or bird damaged poles and broken strands on conductors. Porcelain insulators will allow a flash over if they lose too much of the skirt. Broken crossarms, damaged poles or bent brackets and braces can allow conductors to touch the ground or come into contact with each other. These situations, if not corrected, allow a potential wildfire to exist.

Not only do the aforementioned situations create potential fires, they lead to other problems which the utilities are anxious to repair as soon as possible. If you find any of these situations to exist, immediately notify the utility company having jurisdiction, that the conditions exist and the exact location of those conditions.

Vegetation should not be cleared from right-of-ways, except as necessary to effect required clearance around poles and towers, as the vegetation holds soil in place and presents a natural environmental appearance.

Situations exist in which the minimum legal clearance is clearly inadequate, such as localized high or turbulent winds found in canyons or extremely high local air temperatures in low elevation canyons.

Hazardous conditions may also occur from natural or man-made causes. Snags left from old burns or insect kills sharply increase the potential for dead or dying trees to fall into power lines. In these instances it may be necessary to fall or trim trees beyond the legally required distance from conductors.

Standard unprotected conductors, for primary distribution lines, and self-supporting aerial cable, can only be attached to trees in accordance with Title 14, Section 1257. However, in no case are conductors of any kind to be mounted to snags or dead trees.

8. Training

This Guide is to be used as a reference for personnel already familiar with the subject areas contained within.

This Guide is also to be used as the base level of knowledge necessary to perform adequate, accurate, and complete inspections which require that personnel using this guide be properly trained as to the application of the contents of this guide.

Training is available through the CDF Fire Academy, Region Office Fire Prevention Section or the CDF Unit Fire Prevention Bureau.

Inspection Policies

Basic Laws Pertaining to Power Line Operations Quick Reference Table

Public Resources Code

PRC Section 4292: <i>10 Foot Fire Break Required</i>	1-26
PRC Section 4293: <i>Conductor Clearance Required</i>	1-27

4 Feet2.4 - 72 kV

6 Feet72 - 110 kV

10 FeetOver 110 kV

PRC Section 4294: <i>Aerial Cable Exempt from Conductor Clearance</i>	1-27
PRC Section 4295: <i>Trespass Not Required</i>	1-27
PRC Section 4296: <i>Lines with 750 Volts or Less are Exempt</i>	1-28

California Code of Regulations Title 14, Article 4

Section 1251: <i>Definitions</i>	1-31
Section 1252: <i>Location where PRC 4292 and PRC 4293 Apply</i>	1-31
Section 1253: <i>Time when PRC 4292 - PRC4296 Apply</i>	1-32
Section 1254: <i>Minimum Clearances - PRC 4292</i>	1-32
Section 1255: <i>Exemptions to Minimum Clearance Provisions of PRC 4292</i>	1-33
Section 1256: <i>Minimum Clearance Provisions of PRC 4293</i>	1-34

9. Exemption Policy

Policy for Qualifying Electrical Equipment and Devices for Exemption from Public Resources Code Section 4292.

The utility will submit all exemption requests to CDF's Fire Prevention Engineering Section at Sacramento Headquarters and will include at least the following:

- ◆ Photograph's and description of equipment/devices tested (photo size 8 x 10 minimum)
- ◆ Description of testing procedures, i.e. ANSI Standard C37.40 - 1981
- ◆ Test results
- ◆ Professional Electrical Engineers conclusions

Written notification will be forwarded to the utility within 60 days after receipt of the request for exemption by CDF. Notification will consist of at least the following:

- ◆ Approval or denial of exemption
- ◆ Justification for the determination

9.1 Exemption Procedures:

Equipment and devices will be tested to ensure compliance according to the test procedures outlined in this standard prior to obtaining an exemption from Public Resources Code Section 4292 from the California Department of Forestry and Fire Protection.

- ◆ CDF Fire Prevention Engineering Section will be notified 30 days prior to an exemption test.
- ◆ The electrical tests, for determining compliance, will be conducted under the direction of an Electrical Engineer using test equipment capable of making and breaking preset loads. The current, voltage and starting and ending times shall be graphically recorded and become a permanent part of the documentation of the request for exemption.
- ◆ Tests will be conducted utilizing a fuel bed representative of flammable vegetation (dead, dried grass or equivalent), with a fine fuel moisture of 5% at 70° - 89° degrees Fahrenheit and an accompanying wind speed of 10 MPH or more.
- ◆ All equipment installed on lines shall be operated within the maximum manufacturers duty rating of the equipment or device.
- ◆ Equipment will be installed under actual field conditions according to manufacturers specifications while undergoing testing.
- ◆ Enclosed devices, i.e., reclosers, sectionalizers, autotransformers, non-expulsion devices etc., shall be designed so no external arcs/sparks or expelled hot particles will be generated during the operation.
- ◆ Open type or fixed devices, i.e., air switches, open link fuses, connectors, lightning arresters, manual by-pass switches and disconnects shall interrupt line current and short circuit current within the design range without creating arcs/sparks or hot particles that would ignite flammable vegetation.
- ◆ The equipment or overhead device, when installed according to the manufacturers recommendations, must be fire safe, by test, where exposed/anticipated electrical arcs or hot material could be generated.
- ◆ Overhead line equipment and devices that may generate exposed electrical arcs, sparks or hot material during their operation shall be designed to limit any such arcs, sparks or hot materials sufficiently to prevent the ignition of flammable vegetation.
- ◆ Igniting any portion of the test bed will disqualify the device when testing is conducted in the above described environment.

10. Inspection Policy

Both utilities and fire protection agencies have responsibilities for inspection of power lines. However, the reasons and purposes of their inspections are different. Although joint inspections are desirable and helpful, often they are not practical.

The utilities have an operational and management responsibility for inspecting their lines. They must determine what work needs to be done in order to comply with laws and use permits, and to prevent fires and avoid interruption of customer service. They also need to know, after the work is assigned, whether or not it has been done and to what standards.

The fire and resource protection agencies' inspection responsibilities are primarily regulatory. They should make inspections (spot checks) of as small or large an area as necessary (seldom a complete inspection of an entire circuit) to satisfy themselves that the electric utility complies with regulations. These inspections should normally be done in late spring or early summer. The protection agency should notify the utility in writing of its findings.

Correction of violations and maintenance of required clearances and other safety measures are the responsibility of the utilities. Much of the clearance work is done by contractors. Neither contractors nor utility company employees should pass by an obvious violation or other problem because it is not on their assigned work list. Also, fire protection agency personnel should never ignore an observed violation or piece of broken or damaged equipment. It should be reported to the utility, in writing, so that the defect may be promptly corrected.

The California Department of Forestry and Fire Protection, USDA Forest Service, US Bureau of Land Management, and other wildland protection agencies may initiate criminal actions to secure compliance with laws and ordinances. These agencies also may process civil actions for collection of fire suppression costs and damage to their resources. Protection agencies will not take indiscriminate actions. However, when violations are present and can be supported by facts, a citation or criminal complaint may be issued.

10.1 Utility Company Inspections

The responsibility for inspection of power lines for compliance with laws and regulations, rests exclusively with the utilities.

The most basic method of power line inspection is visual, conducted by ground or air. This method of inspection can determine accurately whether required clearances exist, structures are in need of repair, etc.

An infrared (IR) scan is used to detect components with thermal anomalies. Improper or loose connections, as well as most other incipient deterioration, create electrical resistance and, therefore, heat. Heat often cannot be detected visually but shows up clearly during an IR scan.

In terms of exposure, there are 5 to 10 times as many miles of distribution lines as transmission lines. Fire protection agency statistics show that more fires start from distribution lines than from transmission lines. Distribution circuits commonly carry more non-exempt hardware (clearance required) and are built with less conductor clearance than are transmission lines. Therefore, distribution lines should also receive frequent inspection.

The frequency of inspection of both transmission and distribution lines depends on various other factors, such as: type and growth rate of vegetation, accessibility to fire fighting forces, frequency of strong or gusty winds and fire history. Inspection schedules must be flexible enough to accomplish their purpose.

10.2 Fire Protection Agency Inspections

The fire protection agencies are charged with the responsibility of protecting the public from loss of life, property and resources by fire. They are also charged with enforcing the forest and fire laws. To accomplish these missions, they inspect power lines to prevent wildfires. Protection agency inspections do not, however, relieve public utilities of the responsibility of inspecting their own facilities. Public fire protection agencies do have a duty to make known to utilities those violations and defects noted during their inspections. Protection agency personnel will seldom make a complete inspection of an entire circuit. Their procedures include: spot inspections of individual poles, towers, spans, or short segments of circuits; general surveys (usually by air); compliance checks following prior notification of violations; detailed inspections of small areas (because of fire or complaint).

Most fire agency inspections are adequately conducted by visual inspection. Inspectors should be equipped with such aids as binoculars, magnifying glasses and cameras. The use of such equipment is particularly important when making fire-cause investigations, but can also be quite helpful in conducting inspections. Because of the danger of electrocution, fire agency personnel are NOT to attempt to physically or mechanically measure conductor clearances. Visual estimation is adequate.

The result of any fire agency inspection should be properly recorded. Each agency has its own forms and procedures for this purpose. Fire-cause investigations will usually be recorded on special forms. Other types of useful forms which are used by the CDF, USFS and BLM in California, are the California Fire Safety Inspection Report (LE -38, LE-38A) or the USFS version (5100-209), (Figure 2, page 1-15) (Figure 3, Page 1-16) Regardless of the format of the report, a copy should be sent or given to the operating utility. Reports should be specific enough for the utility to act on their findings and for the courts to relate them to complaints or other legal actions in the event such actions are filed.

Protection agency personnel frequently notice conditions on power lines that are not violations of fire laws or regulations but which may cause an electric fault, a hazard to linemen, a break in customer service, etc. When noticed, such items should be noted on the inspection report and/or reported to the utility immediately. Verbal notice is usually adequate but should be followed up with a written notice. Should a wildfire occur as a result of a fault, hazard or violation, etc., proper recording is necessary to establish liability and criminal negligence.

A planned program of inspections to gain compliance with fire prevention laws, aimed at reducing wildfire occurrence, will be carried out by the CDF. The program must be as long range and flexible as needs require.

As hazard and risk problems change, the emphasis of any fire prevention program must also change to meet the problem.

Success depends on the fire prevention inspector and the inspection program. The inspector's aim must be to handle all contacts in such a way that people will be favorably impressed and will have confidence in CDF.

The authority for the CDF, USFS, and BLM to enforce California forest and fire laws is Public Resources Code, Section 4119 that authorizes the Department or authorized agents to inspect all properties, except a dwelling's interior, to ascertain compliance with state forest and fire laws.

To perform the inspection successfully, the inspector should have specific tools:

- A. Badge, name plate and shoulder patch.
- B. Agency identification card.
- C. The California Interagency Fire Safety Inspection Form and a notebook to record the inspection and to take notes of hazards and risks. Sketched maps aid in future inspections or fire fighting operations.
- D. Copies of laws, ordinances and fire prevention material.
- E. Prior inspection records.
- F. Binoculars, camera and circuit maps if available.

After completing the inspection, the inspector should note all violations in writing on the Interagency Inspection Form and set a definite time limit for compliance. The time limit should be reasonable for the amount of work to be done. The inspector may consult the electric utility and jointly set the time limit, if within reason, since the work will more likely be completed on time.

The more critical the situation, the more urgent compliance becomes. However, weather conditions, stage of the vegetation cure and approaching windy seasons should dictate allowable time for the work's completion.

Follow-up inspection is absolutely necessary for effective inspections. The electric utility should understand that the inspector will be re-inspecting the violation immediately after the date set for compliance. If the inspector does not go back, the value of the inspection will be lost and a potential fire may still continue to exist.

10.3 Joint Inspections

Joint inspections are for the purpose of educating both fire protection agencies and electric utility personnel with possible violations and other power line problems. Joint inspections are not always possible because of time commitments or agency policy. They are, however, encouraged to the extent feasible, as they provide an excellent opportunity for mutual training, understanding and trust.

Usually the most productive form of joint inspection is the quick general survey of a complete circuit from either a motor vehicle or aircraft. Joint inspections should be documented.

10.4 Ground Inspections

Ground inspections may be made either in a motor vehicle or on foot. In either case, they are most efficiently performed by two-person teams. When inspecting from a vehicle, one team member should devote his entire attention to driving while the other observes the power line. The speed of the vehicle should be that needed for good observation.

Power lines often do not follow roads, or even off-road routes. Therefore, inspection must sometimes be done on foot. These segments often contain the greatest number of violations. In order to avoid wasting time, one person should walk the line while the other drives to a point where the line again crosses a road. If the line crosses the road and again goes cross-country, the team members can switch roles.

10.5 Aerial Inspections

Aerial inspection is an excellent means of covering a lot of territory quickly and at minimum cost. Some of the larger utilities own and operate their own aircraft. There are several contractors who fly regularly for both power and telephone utilities. Most protection agencies have aircraft

available. Several cost studies have shown that aerial inspection is less expensive than ground inspection in off-road situations that would otherwise require walking.

Helicopters may be used for power line inspections. Their maneuverability and ability to fly slowly and to hover makes them ideal for this purpose. Cost per flight hour is, however, from two to eight times that of an appropriate fixed-wing aircraft, and cost must be weighed in respect to the thoroughness of inspection needed. It has been demonstrated that with proper planning, preparation, training (of both pilot and observer) and experience, an adequate job of power line inspection can be accomplished from the air using either helicopters or fixed-wing aircraft. Results of aerial inspections should be ground checked until both pilot and observer have accumulated experience.

Aerial inspection is particularly good for spotting pole or tower clearances, leaning or dead trees not immediately adjacent to the line and the larger pieces of hardware requiring pole or tower clearance. It is also an excellent means of making infra-red inspections. A skilled observer can do many phases of power line inspection equally well from the air as from the ground. However, it is rather difficult to identify small items of hardware, conductor clearances or the less obvious tree defects accurately from the air.

11. Location Identification

Wildland fire protection agencies and electric utilities have two different systems of position or location identification. In order for communications (including inspection reports, inquiries regarding problems, etc.) to be meaningful, it is essential that both groups of people have at least a working knowledge of the other's system. There is not space here to completely define either system. Local joint training sessions should be utilized to acquaint personnel with these systems.

Most wildland fire protection agencies use the so called "GLO" (General Land Office) system of position location. This system defines locations by means of section, township and range. More detailed locations will be given by quarter section. This grid system is relatively easy to learn, but not always easy to apply accurately on the ground. The grid is usually superimposed on fire agency administrative maps, USGS topographic maps, and other maps. It is seldom shown on utility maps because it is not sufficiently precise to identify the location of an individual pole, tower, or conductor span.

The electric utilities, with some variation between systems, generally identify locations by circuit name, number and pole, tower or hardware number. Transmission lines usually are named and each pole or tower is numbered. One common system of such numbering is a fraction, the top number being the mile from the point of beginning and the bottom number being the number of the pole or tower within that mile. Other numbering systems are in use and the system used by a particular utility must be learned by fire agency personnel. Depending on the utility, distribution circuits may be numbered, named or both. Some utilities also number individual poles as well as just identify Subject Poles. Also, items of major equipment (e.g. automatic reclosers, switches, disconnects, etc.) are numbered. Poles without pole or equipment numbers must be located by reference to existing pole or equipment numbers (e.g. "fourth pole north of disconnect 6859", or "second pole west of pole 1892096E"). (See Figure 4 and 5, Page 1-17)

CALIFORNIA INTERAGENCY FIRE SAFETY INSPECTION LEGAL NOTICE

591651

Figure 2

INSPECTOR'S NAME: TITLE:

DATE OF INSPECTION: MONTH DAY YEAR

OTHERS PRESENT:

MAY BE CONTACTED AT: ()

INSPECTEE'S NAME: ADDRESS:

LOCATION OF INSPECTION:

FOLD LINE

FOLD LINE

- NO VIOLATION OBSERVED AT THIS TIME. INSPECTION STICKER ATTACHED. YOU ARE HEREBY NOTIFIED TO CORRECT THE VIOLATIONS SPECIFIED BELOW. BEFORE OPERATING EQUIPMENT LISTED. VIOLATION TAG ATTACHED. REINSPECTION WILL BE MADE ON OR AFTER MONTH DAY YEAR

SEE "EXCERPTS FROM STATE AND FEDERAL LAWS" BELOW. NOTE SECTIONS CHECKED.

FOLD LINE

FOLD LINE

EXCERPTS FROM STATE AND FEDERAL LAWS

(PRC) Public Resources Code (H&SC) Health & Safety Code (CAC) California Administrative Code

LEGAL AUTHORITY Certain Forest Service Officers are authorized to enforce State Fire Laws. They are:

- 1. Those who hold Voluntary Fire Warden and Peace Officer's appointments from the California Department of Forestry. 2. Other Forest Service employees designated annually pursuant to the joint Forest Service/California Department of Forestry Fire Cooperative Agreement.

PERMITS FOR BURNING A person shall not burn any brush, stumps, logs, fallen timber, fallows, slash, grass, brush, forest, or other flammable material in any area receiving fire protection by the department or upon federal lands administered by the United States Department of Agriculture or Department of the Interior, unless he has a written permit from the department or its duly authorized representative or the authorized federal officer on federal lands administered by the United States Departments of Agriculture or Interior and in strict accordance with the terms of the permit. (PRC 4423)

CAMPFIRES A person shall not light, maintain, or use a campfire upon any brush, grass, or forest covered land which is the property of another person unless he first obtains a written permit from the owner, lessee, or agent of the owner or lessee of the property. If campfires have been established and posted for camping, a permit is not necessary. (PRC 4433)

USFS FORM R6-5100-209 (REV. 12/89) CDF FORM LE-38 (REV. 12/89)

FIRE HAZARD REDUCTION AND EQUIPMENT

CLEARANCES AROUND STRUCTURES

Any person that owns, leases, controls, operates, or maintains any building or structure in, upon, or adjoining any mountainous or forest, brush, or grass covered lands, or any land covered with flammable material, shall do all the following:

- (a) Maintain around and adjacent to building or structure a fuelbreak for a distance of not less than 30 feet on each side or to the property line, whichever is nearer. This does not apply to single trees, ornamental shrubbery, or similar plants which are used as ground cover, if they do not form a means of rapidly transmitting fire from the native growth to any building or structure. (b) Maintain around and adjacent to any building or structure additional fire protection or firebreak which is located from 30 feet to 100 feet from such building or structure or to the property line, whichever is nearer, as may be required by the Director, because of extra hazardous conditions. Grass and other vegetation located more than 30 feet from such building or structure and less than 18 inches in height above the ground may be maintained where necessary to stabilize the soil and prevent erosion. (c) Remove that portion of any tree which extends within 10 feet of the outlet of any chimney or stovepipe. (d) Maintain any tree adjacent to or overhanging any building free of dead or dying wood. (e) Maintain the roof of any structure free of leaves, needles, or other dead vegetative growth. (f) Provide and maintain at all times a screen over the outlet of every

chimney or stovepipe. The screen shall be constructed of nonflammable material with openings of not more than one-half inch in size. (PRC 4291)

INCINERATORS

Every person shall exercise reasonable care in the disposal of flammable material so that the material does not cause uncontrolled fire. A person shall not burn any flammable material in any incinerator within any area receiving fire protection by the Director or upon federal lands administered by the United States Department of Agriculture or Department of the Interior, unless the following minimum requirements are complied with:

- (a) The area within 10 feet of the incinerator is maintained clear of all flammable material and vegetation. (b) A screen constructed of a nonflammable material, with no greater than 1/4 inch mesh, or metal doors, cover each opening in the exterior to prevent the escape of burning material. (c) A permit is obtained prior to burning. (PRC 4446)

EQUIPMENT

During any time of the year when burning permits are required in an area, no person shall use or operate any motor, engine boiler, stationary equipment, welding equipment, cutting torch, lat pot, or grinding device which is located on or near any forest, brush, or grass covered land, without doing both of the following:

- (a) Clearing away all flammable material, including snags, around such operation for 10 feet. (b) Maintain one serviceable round point shovel and one backpack pump water type fire extinguisher ready for use at the immediate area during the operation.

(CONTINUED ON REVERSE SIDE)

7540-130-0038

INSPECTEE COPY

FS 5100-209 and CDF LE-38

Figure 3

INTERAGENCY FIRE HAZARD INSPECTION NOTICE

012648

Inspector's Name:		Inspection Date: / /	Ranger Unit ID	Batt. No.
Inspector's Phone #:				

Inspector's Title:

- FC FAE FOR AIDE FOR 2 FPA
 BC FF-1 FOR TECH FPS 1 Other
 VIP FF-2 FOR 1 FPS 2

Inspection No:

- One Two Three

Assessor Parcel: Book - Page - Parcel

Inspectee:

Name:

Street No. Dir. Street Name

City State Zip Code Special Address:

Phone Number Latitude Longitude

Location of Inspection:

Street No. Dir. Street Name

City Reinspection Date: / /

Comments:

Comments:

Number Inspected (enter no.):

<input type="text"/> Structures	<input type="text"/> Camp Fire	<input type="text"/> Fire Tools
<input type="text"/> Mechanical Equipment	<input type="text"/> Open Burning	<input type="text"/> Miles
<input type="text"/> Power Line Poles	<input type="text"/> Incinerator	<input type="text"/> Other
<input type="text"/> Waste Disp. Storage		

Inspected For and Number of Violations (see back):

Code (ex. H&S, CFR)	Section (ex. 4291)	Sub-Section (ex. A, C)	No. of Violations

Legal Action:

- Y Admin None BIA NF
 N Citation Other BLM Other
 Compl't Notice M.RES Private

Land Owner:

Special Use Permit

Protection Responsibility:

SRA	LRA	FRA	Violation	<input type="checkbox"/> Y
<input type="checkbox"/>	<input type="checkbox"/>	<input type="checkbox"/>	Reinspection	<input type="checkbox"/> N
BIA	<input type="checkbox"/>	<input type="checkbox"/>	Address Visible	<input type="checkbox"/> Y
BLM	<input type="checkbox"/>	<input type="checkbox"/>	Fire Resistive Roof	<input type="checkbox"/> N
CDF	<input type="checkbox"/>	<input type="checkbox"/>		<input type="checkbox"/> Y
Contract County	<input type="checkbox"/>	<input type="checkbox"/>		<input type="checkbox"/> N
USFS	<input type="checkbox"/>	<input type="checkbox"/>		<input type="checkbox"/> Y
Other	<input type="checkbox"/>	<input type="checkbox"/>		<input type="checkbox"/> N

Type of Hazard:

- Agriculture CampGround Comm. Wood Construction
 Dwelling Mill Mineral Mtn. Cabin Org. Camp Power Line
 Railroad Resort Road Sales/Ops.Area Waste Disposal Other

Water Storage

Type of Vegetation

- Grass Brush Oak/Woodland Conifer

Form LE-38A (1/00)

THIS IS A LEGAL NOTICE OF FIRE HAZARD VIOLATIONS (IF NOTED ABOVE)

12. Hazardous Tree Identification

Falling trees or limbs can break conductors, damage poles, towers, other structures and equipment, or cause short circuits on power lines. Except in unusual circumstances (hurricane force winds, ice storms, etc.), healthy live trees seldom cause such problems. Trees are subject to injury, disease, insect and fungus attacks and ultimately death. When so afflicted, they become hazardous to power lines or any other improvements.

Most defects are readily apparent to the trained observer. However, some defects cannot be detected with a cursory glance. This chapter describes and illustrates some of the more common tree defects and ways to locate and evaluate them.

12.1 Recognizing Potential Root Defects

- A. Undermined or severed roots caused by erosion or construction activity and roots loosened by saturated soils and winds resulting in 25% or more root exposure.
- B. When grade is altered and 25% or more of the root system and/or the trunk of the tree is buried.
- C. Root rot is a major cause of uprooted trees. Root rot can often be detected in hardwoods by open butt rot wounds at the ground line. In conifers, it is indicated by excessive casting of exterior needles, yellowing, abnormally short needles and internodes, rounding off of the upper crown, and fungus fruiting structures in the cambium layer at the root crown (ground level or on the trunk of the tree).
- D. Root rot may also cause leaning trees.

Defective roots are particularly dangerous because of the risk they pose. ALL OR PART OF THE ENTIRE TREE MAY FALL, CAUSING SERIOUS INJURY TO PEOPLE OR DAMAGE TO PROPERTY, particularly during high winds.

13. Root Defects and Leaning Trees

Leaning trees should be removed when there is a potential for failure of either roots, butt or bole, which may result in contact with and/or damage to utility equipment. If corrective thinning will result in additional lean potential, consideration should be given to removal. Many leaners are caused by outside factors (wind, soil conditions, etc.) which loosen or break the roots. Construction activities which sever roots or strike tree butts and boles also may cause trees to lean, as does the impact of falling trees, either natural or man caused. Humps and soil mounding on the opposite side of the lean direction are indicators of broken or loosened tree roots.

A leaner is often rendered more hazardous because of the presence of open fire wounds or cankers, especially if accompanied by rot. Wounds facing toward or directly opposite the direction of the lean will have the greatest weakening effect.

13.1 Recognizing Heart Rot

- A. Open wounds showing visible rot.
- B. Old wounds that have partially or fully healed over.
- C. Conks anywhere on the bole of the tree
- D. Hollow trunks detected by rapping on the tree trunk or by use of an increment borer.
- E. Decreasing crown vigor.
- F. Cracks or splits not caused by lightning and swelling cankers on the bole.

Heart rot/butt rot is a problem in mature and over-mature trees and is a major cause of breakage. In hardwoods, failures occur often in branches or in crotches than in the bole, but potential bole failures should not be overlooked.

Basal fire scars and mechanical injury to the bole are a major entry point for butt and heart rot. Species especially susceptible to this kind of defect are non-resinous conifers such as white fir. When examining these species, it is very important that fire scars are checked for the presence and amount of decay.

13.2 Degree of Hazard from Heart Rot or Butt Rot

- A. Amount of radial wood remaining.
- B. Basic form of the tree relative to weight distribution.
- C. Rate of growth vs. the loss of strength due to decay.
- D. Orientation to the prevailing winds. Potential of failure is greater if the wound faces the prevailing winds.
- E. Other contributing factors (cracks, sap rot, leaning, root rot).

14. Trunk Deformities

Deformities can weaken the bole and increase the chance of breakage at the point of deformity.

Deformations are caused by the following:

14.1 Dwarf Mistletoe Cankers

Swellings of the bole resulting from infection by dwarf-mistletoe are quite prevalent on both white and red firs. When these swellings first begin there is minimal weakening of the trunk. As the cambium in the oldest part of the swelling dies, structural weakening becomes more prevalent. Breakage at the canker location is likely to occur when the width of the dead face approaches half the circumference of these swellings. Trees in this condition should be removed. Cankers or otherwise flattened areas oriented to the windward or to the leeward side of the bole are more likely to fail than similar areas oriented parallel to the direction of strong winds.

Open dwarf-mistletoe cankers are sometimes found on the lower trunks of Ponderosa and Jeffrey pines, but resin infiltration prevents the wood from decaying. Therefore, such mistletoe cankers on these species have a lower likelihood of being hazardous, but should still be closely evaluated since some structural weakness might be possible.

Cankers, thought to result from infection by rust fungi, occur in pines. The wood around these cankers may remain sound for years, but trees with such cankers could eventually develop structural weaknesses, particularly when the depression is deep and located sixteen feet or more above the base of the tree.

14.2 Man Caused Deformities

Flattening of the tree trunk may be caused by the attachment of pieces of wood or steel members to trees to serve as cross arms for utility lines or for use as building supports. Fastening wires and cables around the trunk for various purposes deforms and weakens the tree. The guidelines for cankers and rusts can be used for evaluating risk.

Forked trees with tight v-shaped crotches are susceptible to splitting and breaking off at the crotch. This problem is prevalent mostly in mature trees in which the members of the fork have grown long and heavy. Hardwoods are more susceptible to this type of failure than conifers because of their wide, spreading crown which results in strong leverage at the crotch and other points of potential weakness.

The inspector should scrutinize forked trees carefully for signs of visible open cracks and splits, included bark, or for callus ridges outlining and closing older cracks. He should also look closely for signs of rot which follow such splits. Even in the absence of splits, rot is sometimes present in crotches to a degree sufficient to render the tree hazardous.

14.3 Combination Defects

When more than one defect or condition influencing the degree of hazard is present in a tree, it is said to have a combination or multiple defect. Often a tree with only one bole defect will not be weakened structurally enough to be considered hazardous but with a second or third defect, it may be hazardous. A number of different combinations involving two or more defects are possible. Therefore, the inspector should be alert for such combinations.

15. Defective Limbs

Limb failure occurs when the combined forces exerted on the limb exceed the strength of the limb at its weakest point. These forces include the weight of the limb itself, as well as the forces imposed by wind, snow, ice and rain. Most limb failures occur as a result of the presence of defects such as: decay, cracks, splits and breaks, holes from animals, birds (mostly woodpeckers) or insect activities and compression defect.

Hardwoods as a group are more susceptible to limb failures than are conifers because of basic differences in crown form, which in the hardwoods give rise to narrow, structurally weak crotches and also to long branches which become heavily weighted at the extremities. There is a tendency in hardwoods for trunk rot to extend into major limbs and increase the potential for limb failures. In this regard, the true oaks, the eucalyptus and the sycamores merit special attention.

15.1 Size of Limbs

Experience has shown that a very satisfactory degree of hazard control can be achieved by removal of defective limbs larger than a specified diameter and length. The detailed guidelines which follow are based on this concept.

15.2 Location of Limbs

A basic principle in tree hazard control is that a potential hazard exists only if there is reasonable probability of injury damage. Before a situation can be said to be potentially hazardous from tree limbs, two basic elements must be present: (a) defective limbs, and (b) limbs located so that in falling they have a reasonable probability of striking power lines.

15.3 Relative Durability of Wood

Dead limbs of most conifers will remain attached for a relatively long time in a safe condition because of their resinous character which renders the limbs resistant to decay. The exception to this exists with the dead wood of the true firs which, due to its non-resinous character, can be expected to decay faster than the dead limbs of other coniferous species. Consequently, the true firs and other conifers should be inspected with these facts in mind.

Dead limbs of hardwoods generally decay faster than do similar limbs in conifers. This faster rate of decay in turn means more rapid development of defective limbs in hardwoods than in conifers.

15.4 Weather Conditions

Weather conditions have an important influence on the number of dead and defective limbs in a tree. Limbs which have withstood snow and ice loads the previous winter are less likely to break and fall later during the milder weather. Many weak and defective limbs are eliminated under snow and ice conditions. This natural testing and elimination of defective and weak limbs does not occur in trees below the snowline: consequently, the limb hazard potential can be greater in such areas.

15.5 Guidelines for Dead Limb Hazard Control

- A. Conifers - Remove dead tops and limbs when:
 - 1. Defects and weakness exist as a result of decay, breaking, cracking, splitting, woodpecker holes or insect activity.
 - 2. Limb size exceeds 3 inches in diameter and 6 feet in length.
- B. Hardwoods - [Except true oaks and madrones]
 - 1. Remove all dead tops and limbs the same as for conifers.
- C. True Oaks and Madrone
 - 1. Remove all dead tops and limbs, when limb size exceeds 2 inches in diameter and 4 feet in length.
- D. Provide for Safety!

In applying these guidelines, the inspector should always bear in mind the fact that in areas with trees, whether natural or planted, the presence of power lines introduces a degree of risk. The inspector's job is to reduce the risk to a reasonable and acceptable level based on sound judgment and experience.

16. Top Defects

16.1 Dead Tops

Dead tops on living conifers, sometimes called "spike tops", may be hazardous in some cases. Experience indicates that spike tops in Sierra redwood, incense cedar, coast redwood, pines and Douglas fir can be considered non hazardous if not structurally weakened by defects such as bad cracks, splits or woodpecker holes, and also, if without bark, which could loosen and fall.

Dead tops in both White and California red firs must be considered hazardous, and such tops should be removed as soon as possible. Because of the non-resinous nature of the wood of these species, it is relatively non-durable and quite susceptible to attack and consequent weakening by decay fungi.

16.2 Broken Out Tops and Volunteer Tops

Conifers with tops that have broken out are not considered to be hazardous, even though there is rot present below the break and a short length of decayed trunk still remains. Volunteer tops that form following the loss of tops in conifers are not considered hazardous so long as such tops remain live. This is true whether such tops are single or multiple. When dead, such tops should be considered a hazard and should be removed. Live volunteer tops have been known to fail under heavy ice and snow loads. Therefore, volunteer tops in snow areas should be removed.

17. Other Crown Conditions

17.1 Thick Growth

Crowns with a heavy, thick growth of live limbs and branches are susceptible to limb failure (as well as bole and root failure) from winds. Corrective pruning is justified to prevent such failures.

17.2 Structure

The overall structure of many hardwoods, as well as some conifers, frequently includes a combination of potentially weak crotches and heavy limbs which render the limbs susceptible to failure at the crotches. Sometimes open cracks or callus ridges may be present as evidence of partial failure, but frequently no such evidence is visible. Through observation and experience, the tree hazard inspector should come to recognize such potentially hazardous conditions. General pruning to reduce limb and crown weight should be considered for control.

18. Techniques and Aids

The inspector should develop certain habits when checking for hazardous trees. Few defects are located at eye level, therefore, he/she must quickly scan the entire tree from the soil surrounding it to the top and the branches. Many conifers are over 100 feet tall, making naked eye inspection of the top and upper branches somewhat difficult, thus binoculars should be part of his equipment.

If any indication is noted of butt, heart or sapwood rot in the lower trunk, the extent of damage should be estimated. A quick, rough estimate can be made by tapping the trunk with an ax handle, night stick, or other similar instrument to determine whether or not it sounds hollow. More precise information can be obtained with an increment borer.

He/she should check the orientation of conks, flat areas, splits, crotches and other deformities in relation to the direction of the power line from the tree and to the prevailing wind direction. If there is little or no possibility that the tree, or a part thereof, might fall into the line, he should go on to the next tree.

Only a few types of defects are dangerous enough to require removal or thinning of the tree if found alone. On the other hand, almost any combination of two or more defects requires corrective action. Therefore, the inspector must always look at the overall situation.

When a tree is found which needs treatment, it must be properly identified for those who will do the work and for follow-up inspection. The tree should be marked with flagging, timber-marking paint or other means. It should be located by map, sketch, or bearing and distance from an identifiable object. In some cases, one or more photographs will be helpful.

An inspector should develop the habit of looking to both sides and to the rear as well as ahead. Many defective trees will be hidden from one direction but not from other directions. Similarly, many defects can only be seen from one or two sides of the tree.

Finally, particularly in dense stands, the inspector should make frequent side trips outside the cleared right-of-way. This is particularly true in coniferous stands. The screening vegetation along the edges of the right-of-way will often hide dangerous trees.

Statutes and Regulations

State Laws

This document has been designed to present only those laws and regulations, or portions thereof, which pertain more or less directly to power line fire prevention in California. As such, this document should only be used as a quick reference. For full and current text, meaning and proper context of laws and regulations, reference should be made to applicable codes, manuals, directives, etc.

Public Resources Code

Section 4021

Penalty

Except as otherwise provided, the willful or negligent commission of any of the acts prohibited or the omission of any of the acts required by Chapter 2 (commencing with Section 4251) to Chapter 6 (commencing with Section 4411), inclusive, of Part 2 of this division is a misdemeanor.

Section 4101

“Person” Defined

“Person” includes any agency of the state, county, city, district or other local public agency and any individual, firm, association, partnership, business trust, corporation or company.

Note: This definition includes publicly-owned utilities (e.g. REA’s, SMUD, L.A. Dept. of Water and Power, etc.). It does not include federal agencies (e.g. Bureau of Reclamation, U.S. Army Corps of Engineers, etc.).

Section 4117

Local Ordinance

Any county, city, or district may adopt ordinances, rules or regulations to provide fire prevention regulations that are necessary to meet local conditions of weather, vegetation, or other fire hazards. Such ordinances, rules or regulations may be more restrictive than state statutes in order to meet local fire conditions.

Section 4119

Enforcing State Forest and Fire Laws Duty of State Officer

The Director of Forestry and Fire Protection, or his duly authorized agent, shall enforce the state forest and fire laws. He may inspect all properties, except the interior of dwellings, subject to the state forest and fire laws, for the purpose of ascertaining compliance with such laws.

Note: By interagency agreement, many employees of the U.S. Forest Service, Bureau of Land Management, National Park Service and certain county fire departments are "duly authorized agents" of the Director of Forestry and Fire Protection.

Section 4125

Classification of Lands as State Responsibility Areas for Fire Protection

The board shall classify all lands within the state, without regard to any classification of lands made by or for any federal agency or purpose, for the purpose of determining areas in which the financial responsibility of the state. The prevention and suppression of fires in all areas which are not so classified is primarily the responsibility of local or federal agencies, as the case may be.

Note: Specific Regulations under this Section can be found in Title 14 Sections 1220-1220.5, California Administrative Code.

Section 4126

State Responsibility Areas: Lands Included

The board shall include within state responsibility areas all of the following lands:

- (a) Lands covered wholly or in part by forests or by trees producing or capable of producing forest products.
- (b) Lands covered wholly or in part by timber, brush, undergrowth or grass, whether of commercial value or not, which protect the soil from excessive erosion, retard runoff of water or accelerate water percolation, if such lands are sources of water which is available for irrigation or for domestic or industrial use.
- (c) Lands in areas which are principally used or useful for range or forage purposes, which are contiguous to the lands described in subdivisions (a) and (b).

Note: Specific Regulations under this Section can be found in Title 14, Sections 1220-1220.5, California Administrative Code.

Section 4127

State Responsibility Areas: Lands Excluded

The board shall not include within this state responsibility areas any of the following lands:

- (a) Lands owned or controlled by the federal government or any agency of the federal government.
- (b) Lands within the exterior boundaries of any city.
- (c) Any other lands within the state which do not come within any of the classes which are described in Section 4126.

Note: Specific Regulations under this Section can be found in Title 14, Sections 1220-1220.5, California Administrative Code.

Section 4128

State Responsibility Areas: Boundaries

In establishing boundaries of state responsibility areas, the board may, for purposes of administrative convenience, designate roads, pipelines, streams or other recognizable landmarks as arbitrary boundaries.

Note: Specific Regulations under this Section can be found in Title 14, Sections 1220-1220.5, California Administrative Code.

Section 4171

Public Nuisances Defined

Any condition endangering public safety by creating a fire hazard and which exists upon any property which is included within any state responsibility area is a public nuisance.

Section 4290

Regulations Implementing Minimum Fire Safety Standards Related to Defensible Space Applicable to State Responsibility Lands

The board shall adopt regulations implementing minimum fire safety standards related to defensible space which are applicable to state responsibility area lands under the authority of the department. These regulations apply to the perimeters and access to all residential, commercial, and industrial building construction within state responsibility areas approved after July 1, 1989. The board may not adopt building standards, as defined in Section 18909 of the Health and Safety Code, under the authority of this section. As an integral part of fire safety standards, the State Fire Marshal has the authority to adopt regulations for roof coverings and openings into the attic areas of buildings specified in Section 13108.5 of the Health and Safety Code. The regulation apply to the placement of mobile homes as defined by National Fire Protection Association standards. These regulations do not apply where an application for a building permit was filed prior to July 1, 1989, or to parcel or tentative maps or other developments approved prior to July 1, 1989, if the final map for the tentative map is approved within the time prescribed by the local ordinance. The regulations shall include all of the following:

- (a) Road standards for fire equipment access.
- (b) Standards for signs identifying streets, roads, and buildings.
- (c) Minimum private water supply reserves for emergency fire use.
- (d) Fuel breaks and greenbelts.

These regulations do not supersede local regulations which equal or exceed minimum regulations adopted by the state.

Section 4291

Reduction of Fire Hazards Around Buildings

Any person that owns, leases, controls, operates, or maintains any building or structure in, upon, or adjoining any mountainous area or forest-covered lands, brush-covered lands, or grass-covered lands, or any land which is covered with flammable material, shall at all times do all of the following:

- (a) Maintain around and adjacent to such building or structure a firebreak made by removing and clearing away, for a distance of not less than 30 feet on each side thereof or to the property line, whichever is nearer, all flammable vegetation or other combustible growth. This subdivision does not apply to single specimens of trees, ornamental shrubbery, or similar plants which are used as ground cover, if they do not form a means of rapidly transmitting fire from the native growth to any building or structure.

- (b) Maintain around and adjacent to any such building or structure additional fire protection or firebreak made by removing all brush, flammable vegetation, or combustible growth which is located from 30 feet to 100 feet from such building or structure or to the property line, whichever is nearer, as may be required by the director if he finds that, because of extra hazardous conditions, a firebreak of only 30 feet around such building or structure is not sufficient to provide reasonable fire safety. Grass and other vegetation located more than 30 feet from such building or structure and less than 18 inches in height above the ground may be maintained where necessary to stabilize the soil and prevent erosion.
- (c) Remove that portion of any tree which extends within 10 feet of the outlet of any chimney or stovepipe.
- (d) Maintain any tree adjacent to or overhanging any building free of dead or dying wood.
- (e) Maintain the roof of any structure free of leaves, needles, or other dead vegetative growth.
- (f) Provide and maintain at all times a screen over the outlet of every chimney or stovepipe that is attached to any fireplace, stove, or other device that burns any solid or liquid fuel. The screen shall be constructed of nonflammable material with openings of not more than one-half inch in size.
- (g) Except as provided in Section 18930 of the Health and Safety Code, the director may adopt regulations exempting structures with exteriors constructed entirely of nonflammable materials, or conditioned upon the contents and composition of same, he may vary the requirements respecting the removing or clearing away of flammable vegetation or other combustible growth with respect to the area surrounding said structures.

No such exemption or variance shall apply unless and until the occupant thereof, or if there be no occupant, then the owner thereof, files with the department, in such form as the director shall prescribe, a written consent to the inspection of the interior and contents of such structure to ascertain whether the provisions hereof and the regulations adopted hereunder are complied with at all times.

4291.1. (a) Notwithstanding Section 4021, a violation of Section 4291 is an infraction punishable by a fine of not less than one hundred dollars (\$100), nor more than five hundred dollars (\$500). If a person is convicted of a second violation of Section 4291 within five years, that person shall be punished by a fine of not less than two hundred fifty dollars (\$250), nor more than five hundred dollars (\$500). If a person is convicted of a third violation of Section 4291 within five years, that person is guilty of a misdemeanor and shall be punished by a fine of not less than five hundred dollars (\$500). If a person is convicted of a third violation of Section 4291 within five years, the department may perform or contract for the performance of work necessary to comply with Section 4291 and may bill the person convicted for the costs incurred, in which case the person convicted, upon payment of those costs, shall not be required to pay the fine. If a person convicted of a violation of Section 4291 is granted probation, the court shall impose as a term or condition of probation, in addition to any other term or condition of probation, that the person pay at least the minimum fine prescribed in this section.

(b) If a person convicted of a violation of Section 4291 produces in court verification prior to imposition of a fine by the court, that the condition resulting in the citation no longer exists, the court may reduce the fine imposed for the violation of Section 4291 to fifty dollars (\$50).

Section 4292

Power Line Hazard Reduction

Except as otherwise provided in Section 4296, any person that owns, controls, operates, or maintains any electrical transmission or distribution line upon any mountainous land, or forest-covered land, brush-covered land, or grass-covered land shall, during such times and in such areas as are determined to be necessary by the director or the agency which has primary responsibility for fire protection of such areas, maintain around and adjacent to any pole or tower which supports a switch, fuse, transformer, lightning arrester, line junction, or dead end or corner pole, a firebreak which consists of a clearing of not less than 10 feet in each direction from the outer circumference of such pole or tower. This section does not, however, apply to any line which is used exclusively as telephone, telegraph, telephone or telegraph messenger call, fire or alarm line, or other line which is classed as a communication circuit by the Public Utilities Commission. The director or the agency which has primary fire protection responsibility for the protection of such areas may permit exceptions from the requirements of this section which are based upon the specific circumstances involved.

Section 4293

Power Line Clearance Required

Except as otherwise provided in Sections 4294 to 4296, inclusive, any person that owns, controls, operates, or maintains any electrical transmission or distribution line upon any mountainous land, or in forest-covered land, brush-covered land, or grass-covered land shall, during such times and in such areas as are determined to be necessary by the director or the agency which has primary responsibility for the fire protection of such areas, maintain a clearance of the respective distances which are specified in this section in all directions between all vegetation and all conductors which are carrying electric current:

- (a) For any line which is operating at 2,400 or more volts, but less than 72,000 volts, four feet.
- (b) For any line which is operating at 72,000 or more volts, but less than 110,000 volts, six feet.
- (c) For any line which is operating at 110,000 or more volts, 10 feet.

In every case, such distance shall be sufficiently great to furnish the required clearance at any position of the wire, or conductor when the adjacent air temperature is 120 degrees Fahrenheit, or less. Dead trees, old decadent or rotten trees, trees weakened by decay or disease and trees or portions thereof that are leaning toward the line which may contact the line from the side or may fall on the line shall be felled, cut, or trimmed so as to remove such hazard. The director or the agency which has primary responsibility for the fire protection of such areas may permit exceptions from the requirements of this section which are based upon the specific circumstances involved.

Section 4294

Aerial Cable

A clearing to obtain line clearance is not required if self-supporting aerial cable is used. Forked trees, leaning trees, and any other growth which may fall across the line and break it shall, however, be removed.

Section 4295

Clearance Not Required

A person is not required by Section 4292 or 4293 to maintain any clearing on any land if such person does not have the legal right to maintain such clearing, nor do such sections require any person to enter upon or to damage property which is owned by any other person without the consent of the owner of the property.

Section 4296

Low Voltage Lines

Sections 4292 and 4293 do not apply if the transmission or distribution line voltage is 750 volts or less.

Section 4435

Origination of Fire-Negligence

If any fire originates from the operation or use of any engine, machine, barbecue, incinerator, railroad rolling stock, chimney or other device which may kindle a fire, the occurrence of the fire is prima facie evidence of negligence in the maintenance, operation, or use of such engine, machine, barbecue, incinerator, railroad rolling stock, chimney or other device. If such fire escapes from the place where it originated and it can be determined which person's negligence caused such a fire, such person is guilty of a misdemeanor.

Health and Safety Code

Section 13001

Causing Fire

Misdemeanor. Every person is guilty of a misdemeanor who, through careless or negligent action, throws or places any lighted cigarette, cigar, ashes, or other flaming or glowing substance, or any substance or thing which may cause a fire, in any place where it may directly or indirectly start a fire, or who uses or operates a welding torch, tar pot or any other device which may cause a fire, who does not clear the inflammable material surrounding the operation or take such other reasonable precautions necessary to insure against the starting and spreading of fire.

Section 13007

Liability for Damage

Any person who personally or through another willfully, negligently or in violation of law, sets fire to, allows fire to be set to or allows a fire kindled or attended by him to escape to, the property of another, whether privately or publicly owned, is liable to the owner of such property for any damages to the property caused by the fire.

Section 13009

Suppression Cost Collectible

- (a) Any person who negligently, or in violation of the law, sets a fire, allows a fire to be set or allows a fire kindled or attended by him to escape onto any forest, range, or non-residential grass-covered land is liable for the expense of fighting the fire and such expense shall be a charge against that person. Such charge shall constitute a debt of such person and is collectible by the person, or by the federal, state, county, public or private agency, incurring such expenses in the same manner as in the case of an obligation under a contract, expressed or implied.
- (b) Public agencies participating in fire suppression, rescue or emergency medical services as set forth in subdivision (a) may designate one or more participating agencies to bring an action to recover costs incurred by all of the participating agencies. An agency designated by the other participating agencies to bring an action pursuant to this section shall declare that authorization and its basis in the complaint, and shall itemize in the complaint the total amounts claimed under this section by each represented agency.
- (c) Any costs incurred by the Department of Forestry in suppressing any wildland fire originating or spreading from a prescribed burning operation conducted by the department pursuant to a contract entered into pursuant to Article 2 (commencing with Section 4475) of Chapter 7 of Part 2 of Division 4 of the Public Resources Code shall not be collectible from any party to the contract, including any private consultant or contractor who entered into an agreement with that party pursuant to subdivision (d) of Section 4475.5 of that code, as provided in subdivision (a), to the extent that those costs were not incurred as a result of a violation of any provision of the contract.
- (d) This section applies to all areas of the state, regardless of whether primarily wildlands, sparsely developed, or urban.

Section 13009.1

Liability of person who negligently sets fire; Burden of proof; Limitation on use of evidence.

- (a) Any person (1) who negligently, or in violation of the law, sets a fire, allows a fire to be set or allows a fire kindled by him or her to escape onto any public or private property... is liable for both of the following:
- (1) The cost of investigating and making any reports with respect to the fire.
 - (2) The costs relating to accounting for that fire and the collection of any funds pursuant to Section 13009, including, but not limited to, the administrative costs of operating a fire suppression cost recovery program.

The liability imposed pursuant to this paragraph is limited to the actual amount expended which is attributable to the fire.

- (b) In any civil action brought for the recovery of costs provided in this section, the court in its discretion may impose the amount of liability for costs described in subdivision (a).
- (c) The burden of proof as to liability shall be on the plaintiff and shall be by a preponderance of the evidence in an action alleging that the defendant is liable for costs pursuant to this section. The burden of proof as to the amount of costs recoverable shall be on the plaintiff and shall be by a preponderance of the evidence in any action brought pursuant to this section.
- (d) Any testimony, admission, or any other statement made by the defendant in any proceeding brought pursuant to this section, or any evidence derived from the testimony, admission or other statement, shall not be admitted or otherwise used in any criminal proceeding arising out of the same conduct.
- (e) The liability constitutes a debt of that person and is collectible by the person, or by the federal, state, county, public, or private agency, incurring those costs in the same manner as in the case of an obligation under a contract, expressed or implied.
- (f) This section applies in all areas of the state, regardless of whether primarily wildlands, sparsely developed, or urban.

Section 13009.5

Charge for use of inmate labor

Where the Department of Forestry and Fire Protection utilizes labor for fighting fires, the charge for their use, for the purpose of Section 13009, shall be set by the Director of Forestry and Fire Protection. In determining the charges, he or she may consider, in addition to costs incurred by the department, the per capita cost to the state of maintaining the inmates.

Title 14, California Code of Regulations

Section 1250

Purpose

The purpose of Article 4 is to provide specific exemptions from: electric pole and tower firebreak clearance standards, electric conductor clearance standards and to specify when and where the standards apply.

Section 1251

Definitions

The following definitions apply to this article unless the context requires otherwise:

- (a) Agency which has Primary Responsibility for Fire Protection means the public agency which is the primary agency responsible for fire prevention and suppression on mountainous or forest-covered land, brush-covered land or grass-covered land within its respective jurisdiction.
- (b) Conductor means a wire or a combination of wires, designed and manufactured for use in the transmission and distribution of electrical current.
- (c) Connector means a splice or a splicing device approved for energized electrical connections.
- (d) Duff means partially decayed leaves, needles, grass or other organic material accumulated on the ground.
- (e) Firebreak means a natural or artificial barrier usually created by the removal or modification of vegetation and other flammable materials for the purpose of preventing the ignition or spread of fire.
- (f) Hot line tap or clamp connector means a connector designed to be used with a grip-All Clamp stick (Shotgun) for connecting equipment jumper or tap conductors to an energized main line or running conductor.
- (g) Outer Circumference means the exterior surface of a pole or tree at ground level or a series of straight lines tangent to the exterior of the legs of a tower at ground level.
- (h) Self-supporting aerial cable means an assembly of abrasion resistant insulated conductors supported by a messenger cable which is normally grounded, designed and manufactured to carry electrical current for installation on overhead pole lines or other similar overhead structures.
- (i) Tree wire means an insulated conductor covered with a high abrasion resistant, usually non-metallic, outer covering, designed and manufactured to carry electrical current for installation on overhead pole lines or other similar overhead structures.

Section 1252

Locations where PRC 4292, 4293 Apply

The minimum firebreak and clearance provision of PRC 4292-4296 are applicable upon any mountainous, forest-covered land, brush-covered land or grass-covered land within state responsibility area unless specifically exempted by 14 CCR, sections 1255 and 1257.

Section 1252.1

Official Area Maps

Areas where the provisions of PRC 4292-4296 apply are delineated on maps for state responsibility areas, as “Official Map State Responsibility Area for Fire Protection”, filed in the Office of the Director, Fire Protection Section, 1416 Ninth Street, Sacramento, California 95814.

- (a) The official maps are available during normal business office hours for viewing and copying.
- (b) When, pursuant to PRC 4125-4128, the Board revises state responsibility area boundaries, the Director will forward a legal description of a boundary change(s) to the respective electric utility(s) serving the area(s).

Section 1252.2

Boundary Location - Roads Etc.

Where the boundaries of areas described in 14, CCR 1252, are along roads, highways, streets, railroads, streams, canals or rivers, the actual boundary shall be the center-line of the course of such roads, highways, streets, railroads, streams, canals and rivers.

Section 1252.3

Boundary Location - Section Lines, Etc.

Where the boundaries of the area described in 14, CCR, 1252, are on section township, range lines or on power line right-of-ways, the poles, towers and conductors located thereon are within the area described.

Section 1253

Time when PRC 4292-4296 Apply

The minimum firebreak and clearance provisions of PRC 4292-4296 are applicable when vegetation, whether living or dead, is flammable and will propagate fire:

- (a) From May 1 through November 15 of each year in the counties of Butte, Colusa, Del Norte, Glenn, Humboldt, Lake, Lassen, Marin, Mendocino, Modoc, Napa, Nevada, Placer, Plumas, Shasta, Sierra, Siskiyou, Solano, Sonoma, Sutter, Tehama, Trinity, Yolo and Yuba;
- (b) From April 15 through November 30 of each year in the counties of Alameda, Alpine, Amador, Calaveras, Contra Costa, El Dorado, Fresno, Kings, Madera, Mariposa, Merced, Monterey, Sacramento, San Benito, San Francisco, San Joaquin, San Mateo, Santa Clara, Santa Cruz, Stanislaus, Tulare and Tuolumne;
- (c) From January 1 through December 31 of each year in the counties of Imperial, Inyo, Kern, Los Angeles, Mono, Orange, Riverside, San Bernardino, San Diego, San Luis Obispo, Santa Barbara and Ventura.

Section 1254

Minimum Clearance Provisions PRC 4292

The firebreak clearances required by PRC 4292 are applicable within an imaginary cylindrical space surrounding each pole or tower on which a switch, fuse, transformer or lightning arrester is attached and surrounding each deadend or corner pole, unless such pole or tower is exempt from minimum clearance requirements by provisions of 14, CCR, 1255 or PRC 4296. The radius of the cylindroid is 3.1 m (10 feet) measured horizontally from the outer circumference of the specified

pole or tower with height equal to the distance from the intersection of the imaginary vertical exterior surface of the cylindroid with the ground to an intersection with a horizontal plane passing through the highest point at which a conductor is attached to such pole or tower. Flammable vegetation and materials located wholly or partially within the firebreak space shall be treated as follows:

- (a) At ground level - remove flammable materials, including but not limited to, ground litter, duff and dead or desiccated vegetation that will propagate fire, and;
- (b) From 0 - 2.4 m (0-8 feet) above ground level remove flammable trash, debris or other materials, grass, herbaceous and brush vegetation. All limbs and foliage of living trees shall be removed up to a height of 2.4 m (8 feet).
- (c) From 2.4 m (8 feet) to horizontal plane of highest point of conductor attachment remove dead, diseased or dying limbs and foliage from living sound trees and any dead, diseased or dying trees in their entirety.

Section 1255

Exemptions to Minimum Clearance Provisions - PRC 4292

The minimum clearance provisions of PRC 4292 are not required around poles and towers, including line junction, corner and dead end poles and towers:

- (a) Where all conductors are continuous over or through a pole or tower; or
- (b) Where all conductors are not continuous over or through a pole or tower, provided, all conductors and subordinate equipment are of the types listed below and are properly installed and used for the purpose for which they were designed and manufactured;
 - (1) Compression connectors.
 - (2) Automatic connectors.
 - (3) Parallel groove connectors.
 - (4) Hot line tap or clamp connectors that were designed to absorb any expansion or contraction by applying spring tension on the main line or running conductor and tap connector.
 - (5) Fargo GA 300 series piercing connectors designed and manufactured for use with tree wire.
 - (6) Flat plate connectors installed with not less than two bolts.
 - (7) Tapered C-shaped member and wedge connectors.
 - (8) Solid blade single-phase bypass switches and solid blade single-phase disconnect switches associated with circuit reclosers, sectionalizers and line regulators.
 - (9) Equipment that is completely sealed and liquid filled.
 - (10) Current limiting, non-expulsion fuses.
- (c) On the following areas, if fire will not propagate thereon;
 - (1) Fields planted to row crops.
 - (2) Plowed or cultivated fields.
 - (3) Producing vineyards that are plowed or cultivated.
 - (4) Fields in nonflammable summer fallow.
 - (5) Irrigated pasture land.
 - (6) Orchards of fruit, nut or citrus trees that are plowed or cultivated.
 - (7) Christmas tree farms that are plowed or cultivated.
 - (8) Swamp, marsh or bog land.
- (d) Where vegetation is maintained less than 30.48 cm (12 inches) in height, is fire resistant, and is planted and maintained for the specific purpose of preventing soil erosion and fire ignition.

Section 1256

Minimum Clearance Provisions - PRC 4293

Minimum clearance required by PRC 4293 shall be maintained with the specified distances measured at a right angle to the conductor axis at any location outward throughout an arc of 360 degrees.

Clearance shall include any position through which the conductor may move considering the size and material of which the conductor is made, span length, foreseeable wind velocities for any location and height, species and flammability of adjacent vegetation.

Section 1257

Exempt Minimum Clearance Provisions - PRC 4293

The minimum clearance provisions of PRC 4293 are not required:

(a) Where conductors are;

(1) Insulated tree wire, maintained with the high density, abrasion resistant outer covering intact, or,

(2) Insulated self-supporting aerial cable, maintained with the insulation intact, or,

(b) On areas described in 14, CCR, 1255 (c);

(c) Except;

(1) Dead and decadent or rotten trees, trees weakened by decay or disease, leaning trees and portions thereof that are leaning toward conductor(s) and any other growth which may fall across the conductor and break it are removed or trimmed to remove such hazard.

(2) The trunk of any tree is not required to be removed when sound and living, and is the supporting structure to which conductor(s) are attached.

Section 1258

Tree Lines

When electric conductors and subordinate elements are fastened to living, sound trees, commonly referred to as tree lines, the requirements of PRC 4292 and 4293 shall apply the same as to a pole or tower line.

Figure 6
PRC 4292
14 CCR 1251
Definition of Outer Circumference Examples
(Plan View at Ground Level)

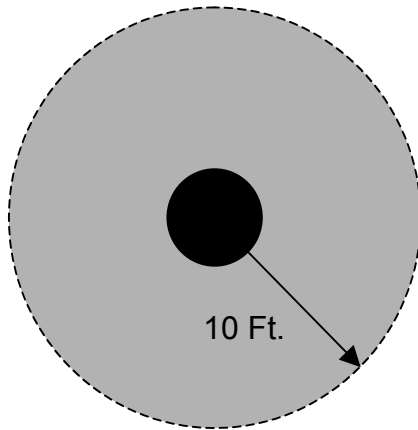

Pole

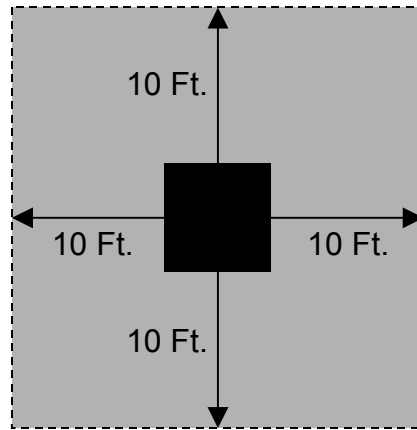

Single Leg Tower

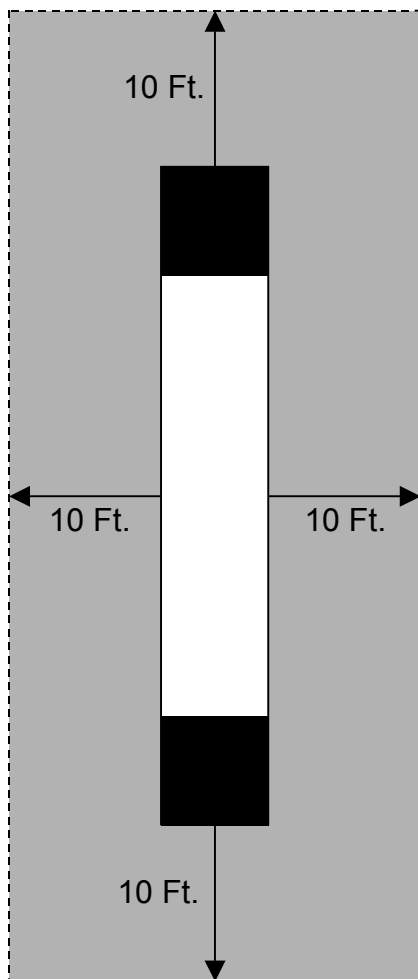

Two Leg Tower

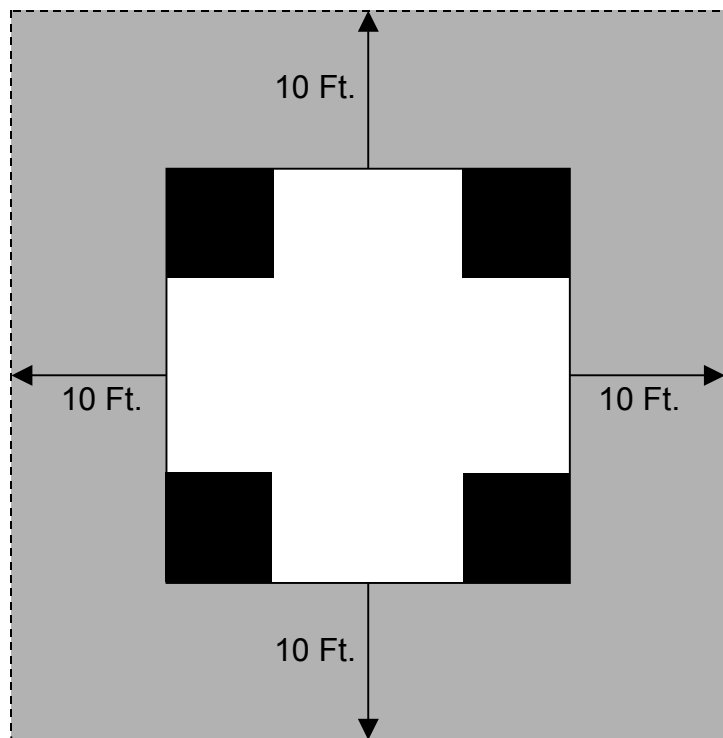

Four Leg Tower

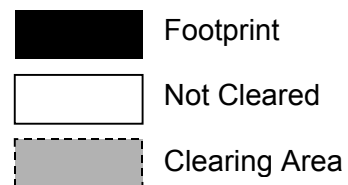

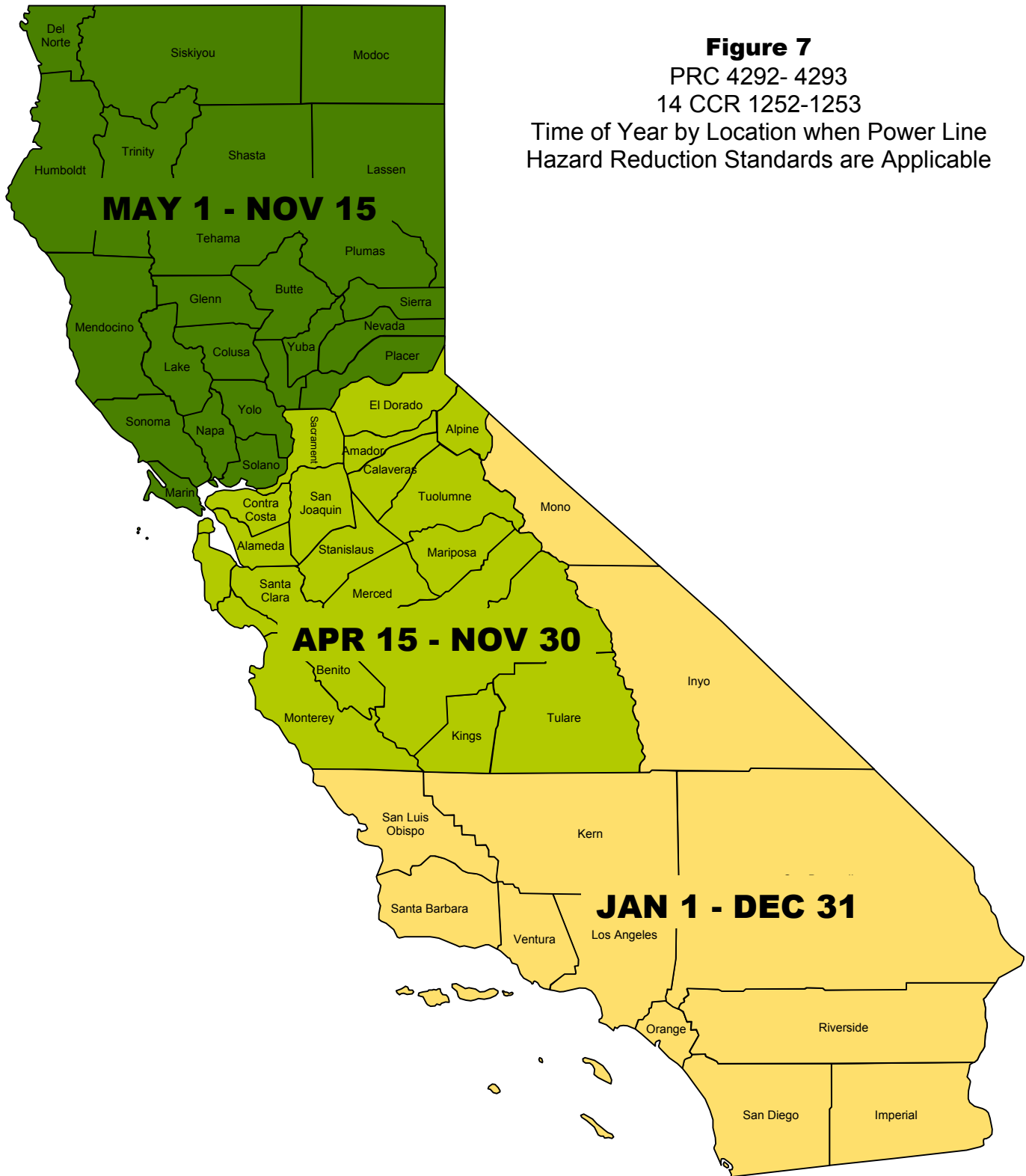

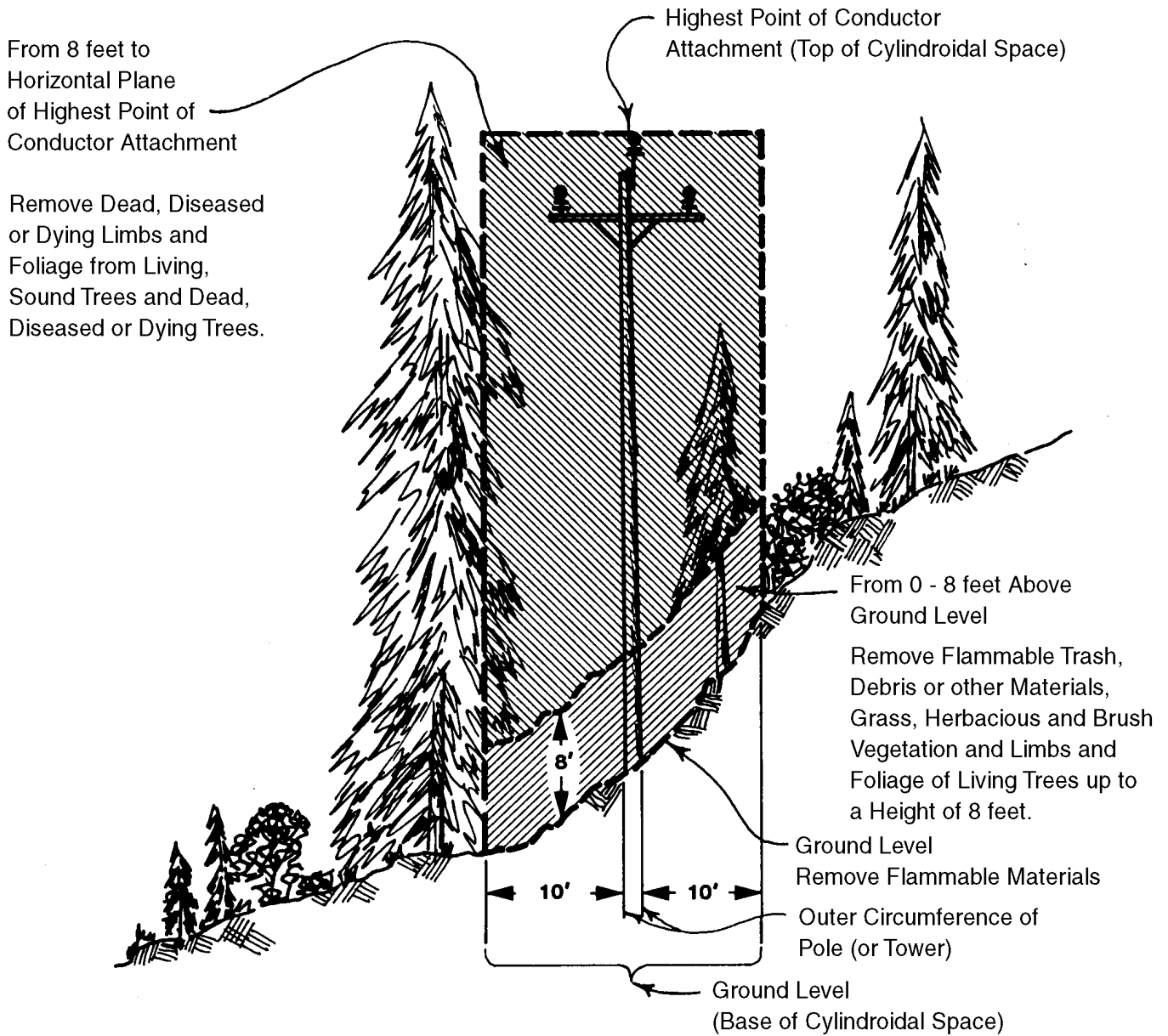

Figure 8
PRC 4292
14 CCR 1254
Fire Break Clearance Requirements
Around Poles and Towers

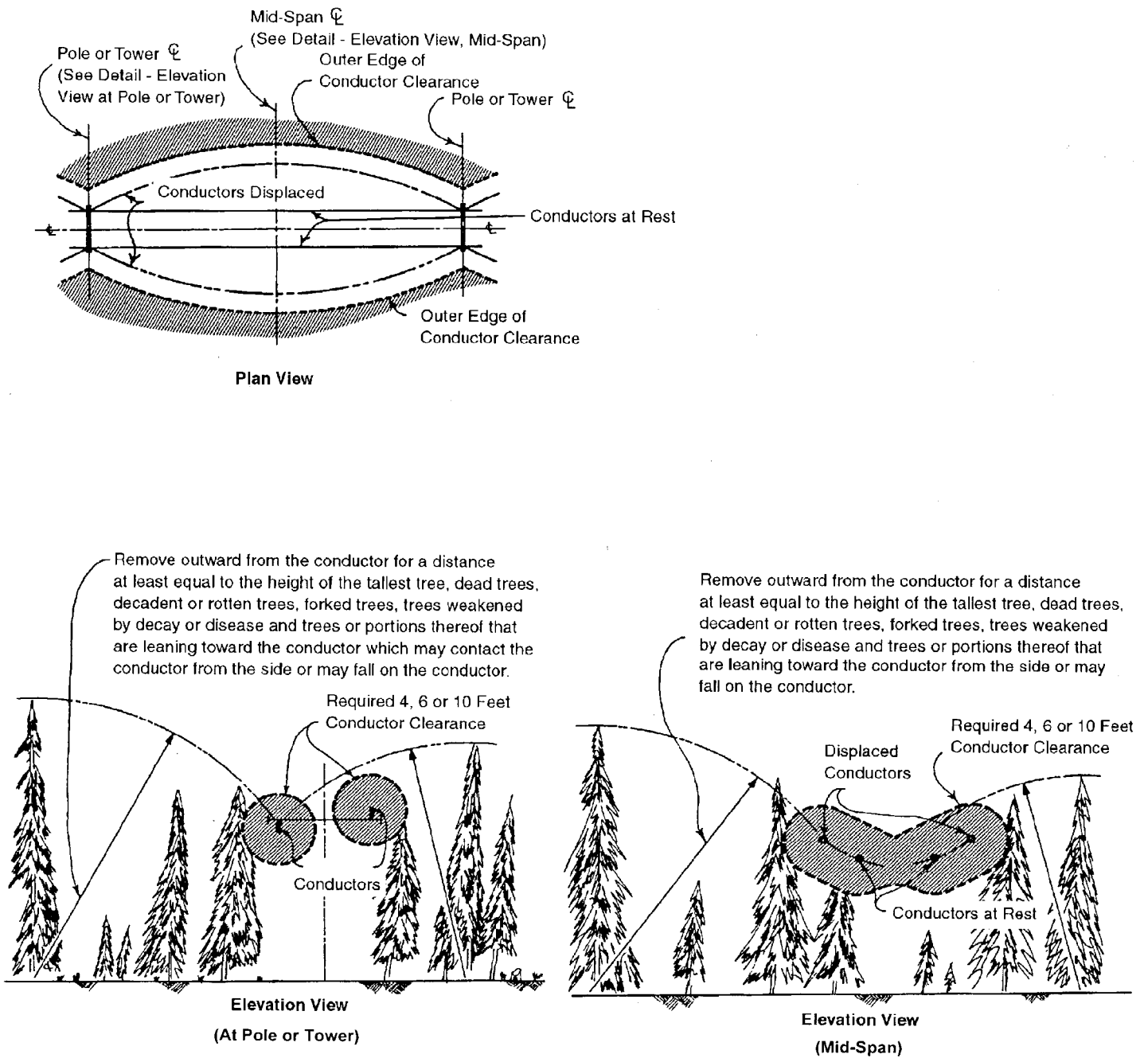
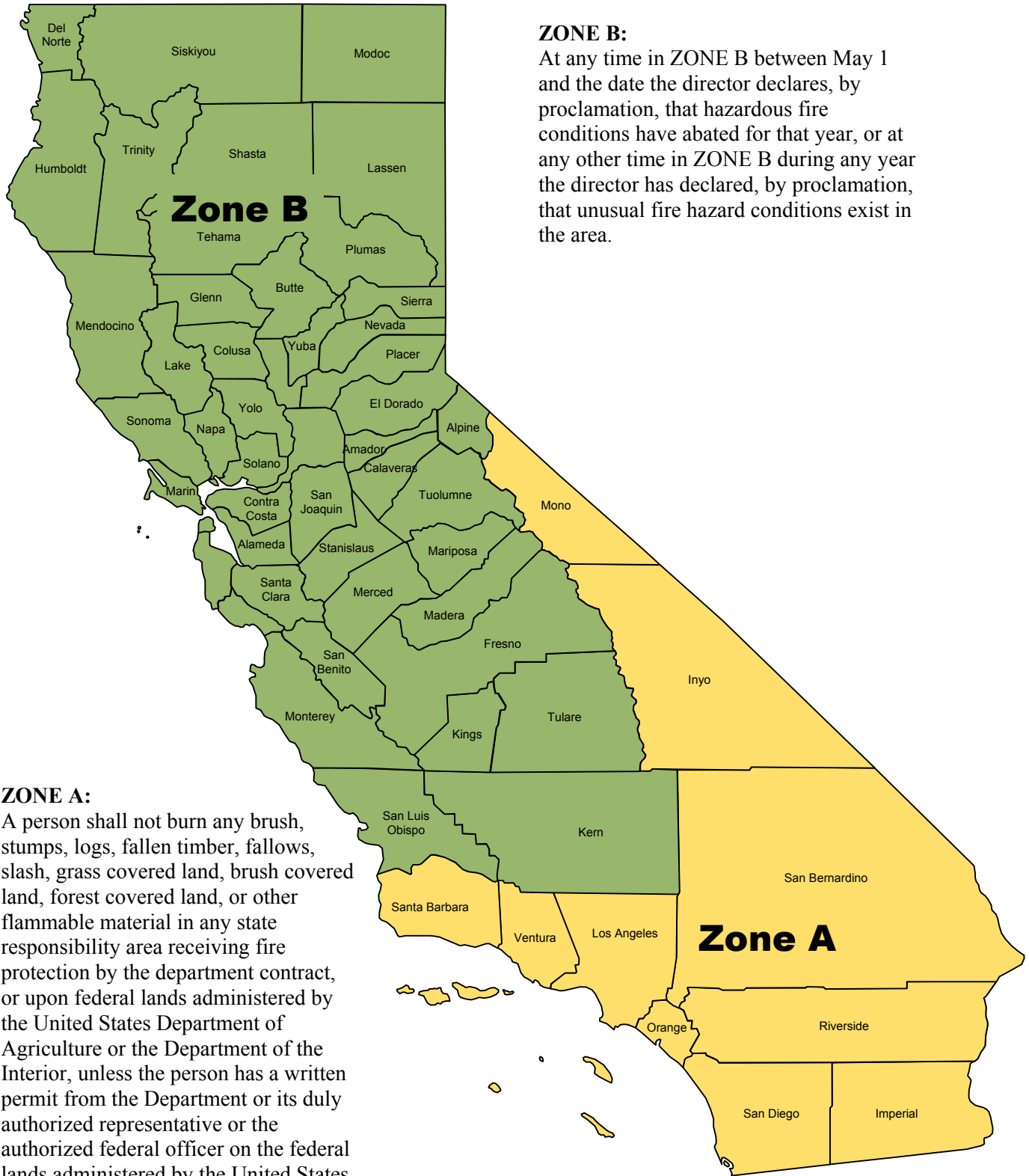

Figure 9
 PRC 4293
 14 CCR 1256
 Conductor Clearance



ZONE B:
 At any time in ZONE B between May 1 and the date the director declares, by proclamation, that hazardous fire conditions have abated for that year, or at any other time in ZONE B during any year the director has declared, by proclamation, that unusual fire hazard conditions exist in the area.

ZONE A:
 A person shall not burn any brush, stumps, logs, fallen timber, fallows, slash, grass covered land, brush covered land, forest covered land, or other flammable material in any state responsibility area receiving fire protection by the department contract, or upon federal lands administered by the United States Department of Agriculture or the Department of the Interior, unless the person has a written permit from the Department or its duly authorized representative or the authorized federal officer on the federal lands administered by the United States Department of Agriculture or the Interior and in strict accordance with the terms of the permit at any time in ZONE A.

Figure 10
 PRC 4423
 Burning Permits; Zones; Times

General Order No. 95, (Public Utilities Commission)

This is a book containing a great many specific rules intended primarily to ensure safe construction, maintenance, operation or use of overhead electrical lines. Utility personnel must be intimately familiar with it.

Protection agency personnel should be generally familiar with it since, although they have no responsibility for enforcing it, they can be of great help to the utilities by observing and reporting to the utilities infractions such as broken insulators or crossarms, deformed structures, sagging conductors, etc.

Code of Federal Regulations

Section 261 - Prohibitions

Section 261.10

Occupancy and Use

The following are prohibited:

- (a) Constructing, placing or maintaining any kind of road, trail, structure, fence, enclosure, communication equipment, or other improvement without a permit.

Section 261.50

Orders

- (a) The Chief, each Regional Forester, each Experiment Station Director, the Administrator of the Lake Tahoe Basin Management Unit and each Forest Supervisor may issue orders which close or restrict the use of described areas within the area over which he has jurisdiction. An order may close an area to entry or may restrict the use of an area by applying any or all of the prohibitions authorized in this subpart or any portion thereof.
- (b) The Chief, each Regional Forester, each Experiment Station Director, the Administrator of the Tahoe Basin Management Unit and each Forest Supervisor may issue orders which close or restrict the use of any forest development road or trail.
- (c) Each order shall:
 - (1) For orders issued under paragraph (a) describe the area to which the order applies;
 - (2) For orders issued under paragraph (b), describe the road or trail to which order applies;
 - (3) Specify the times during which the prohibitions apply if applied only during limited times;
 - (4) State each prohibition which is applied;
 - (5) Be posted in accordance with Section 261.51.
- (d) The prohibitions which are applied by an order are supplemental to the general prohibitions in Subpart A.
- (e) An order may exempt any of the following persons from any of the prohibitions contained in the order:
 - (1) Persons with a permit authorizing the otherwise prohibited act or omission. The issuing officer may include in any permit such conditions as he considers necessary for the protection or administration of the road, trail, or National Forest System or for the promotion of the health, safety, or welfare of its users.

- (2) Owners or lessees of land in the area.
- (3) Residents in the area.
- (4) Any Federal, State, or local officer, or member of an organized rescue or fire fighting force in the performance of an official duty.
- (5) Persons engaged in a business, trade or occupation in the area.
- (6) It is prohibited to violate the terms or conditions of a permit issued under (e) (1).
- (7) Any person wishing to use a Forest development road or trail or a portion of the National Forest System, should contact the Forest Supervisor, Director, Administrator or District Ranger to ascertain the special restrictions which may be applicable thereto.

Section 261.52

Fire

When provided by an order, the following are prohibited:

- (a) Building, maintaining, attending or using a fire, campfire or stove fire.
- (b) Using an explosive.
- (c) Smoking.
- (d) Smoking, except inside a building or vehicle, or while seated in an area at least three feet in diameter that is barren or cleared of all flammable materials.
- (e) Going into or being upon an area.
- (f) Possessing, discharging or using any kind of fireworks or other Pyrotechnic device.
- (g) Entering an area without any fire fighting tool prescribed by the order.
- (h) Operating an internal combustion engine except on a road.
- (i) Welding or operating acetylene or other torch with open flame.
- (j) Operating or using any internal or external combustion engine on any timber-, brush- or grass- covered land, including trails traversing such land, without a spark arrester, maintained in effective working order, meeting either (i) Department of Agriculture, Forest Service Standard 5100-1a; or (ii) the 80 percent efficiency level determined according to the appropriate Society of Automotive Engineers (SAE) recommended Practices J335 and J350.
- (k) Violating any state law specified in the order concerning burning, fires or which is for the purpose of preventing, or restricting the spread of fires.

Note: Under this subsection (261.52(k)) any or all of the state statutes and regulations quoted in Parts I and II of Appendix B, as well as other state laws, may be adopted as federal regulations.

Local Ordinances

Local agencies may have more restrictive regulations. Check with your local fire department.

Terms and Conditions of Permits and Easements

These vary so widely depending on date of issuance, location, issuing authority and type of use that no general statements regarding them are relevant. Some are quite restrictive while others are so loose as to be almost meaningless. Most lie somewhere between the two extremes but two are seldom alike. Employees of both utilities and fire agencies should obtain copies of the specific permits and easements pertaining to the power lines for which they are responsible and become thoroughly familiar with them. Copies or resumes of them should be inserted in this Guide.



Section 2 Non-Exempt

Clearance Required

Universal Fuse



Figure 2-1
Universal Fuse

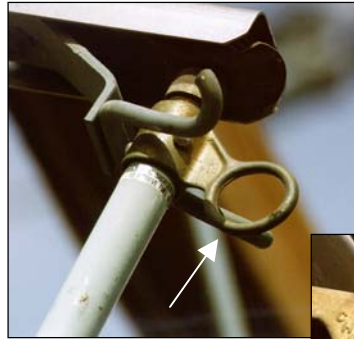

Round pull ring

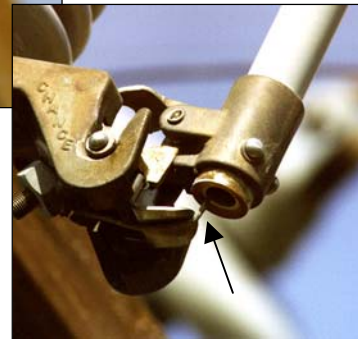

Figure 2-2
Universal Fuse, Fuse link, Expulsion end of fuse

Figure 2-3
Arm Mounted Cutout with Universal Fuses



Open Link Fuse

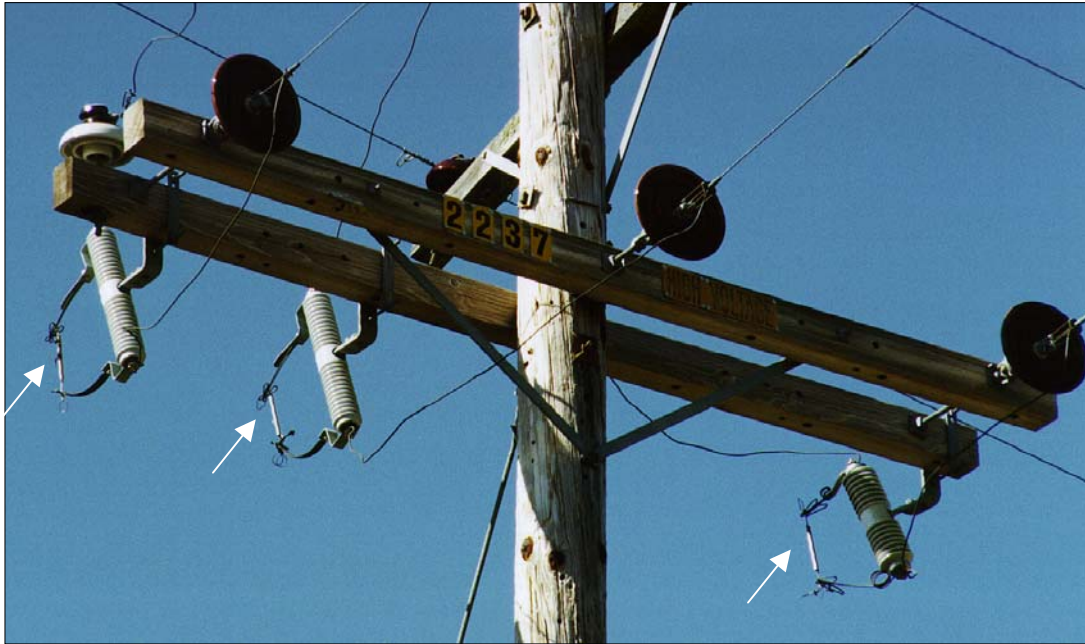
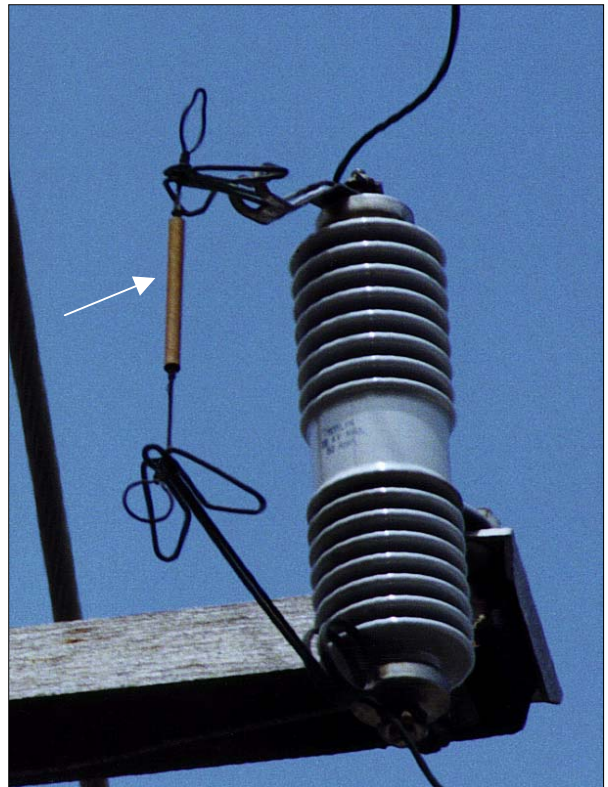

Figure 2-4
Arm Mounted Cutout with Open Link Fuse

Open Link Fuse



Open Link Fuse



Figure 2-5
Bushing Mounted Cutout with Open Link Fuses

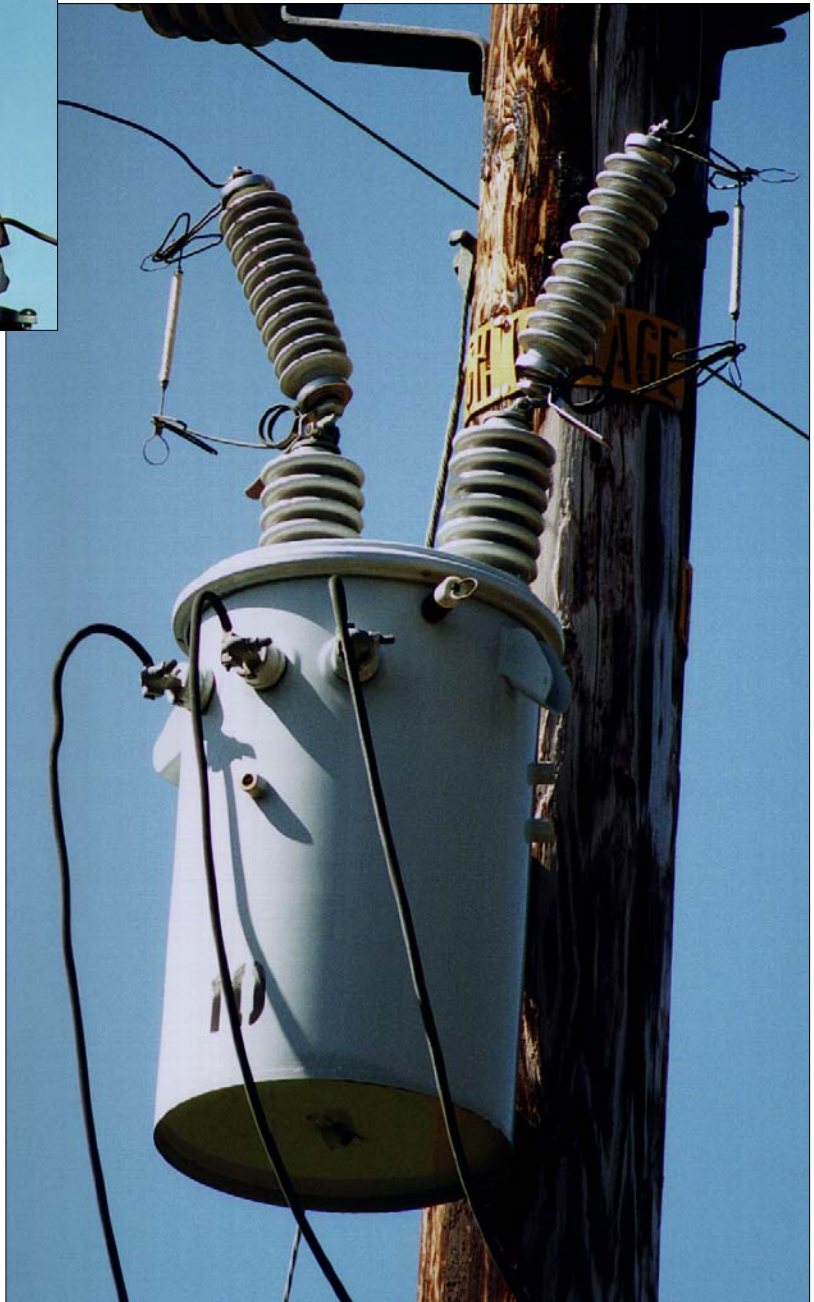

Enclosed Cutout w/ Universal Fuse



Figure 2-6
Enclosed Cutouts

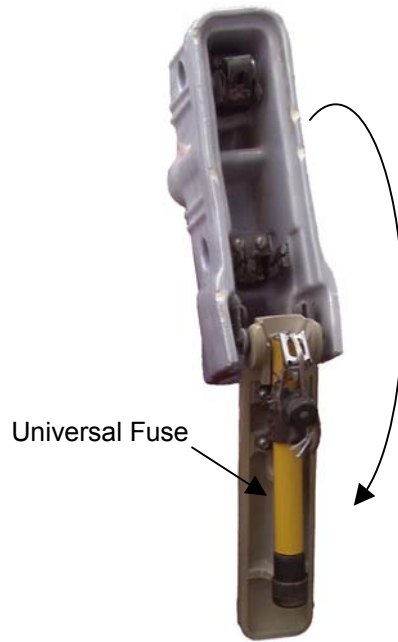

Figure 2-7
Arm Mounted Enclosed Cutout with Universal Fuses



Solid Blade Disconnect



Figure 2-8
**Arm Mounted Cutout with Solid Blade Disconnect
(closed position)**

Figure 2-9
**Arm Mounted Cutout with Solid Blade Disconnect
(open position)**



Note: Solid Blade Disconnects are exempt under certain conditions. See pages 3-13, 3-14 and 3-15.

Solid Blade Disconnects

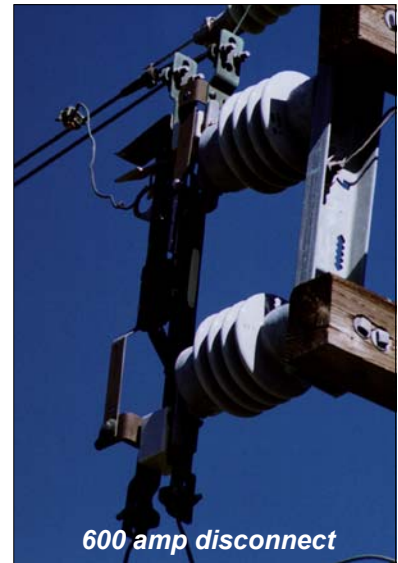
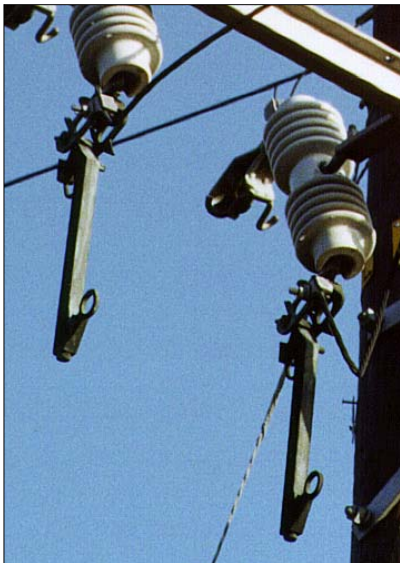

Figure 2-10
Solid Blade Disconnects

Note: Solid Blade Disconnects are exempt under certain conditions. See pages 3-13, 3-14 and 3-15.

Solid Blade Disconnect

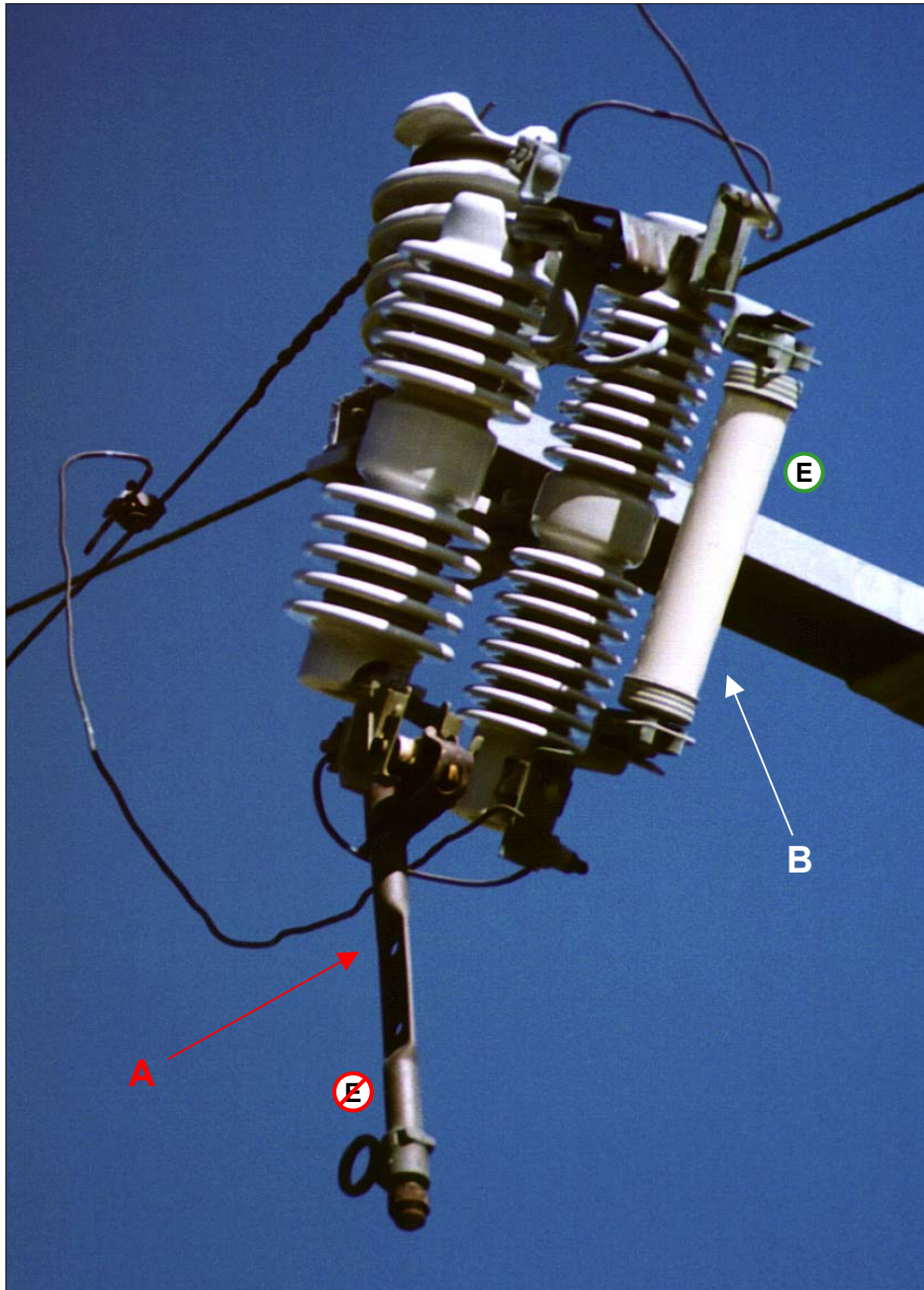



Figure 2-11

A. Solid Blade Bypass Disconnect in Open Position 

B. Arm Mounted Cutout with Non-Expulsion Fuse 

In-Line Disconnect

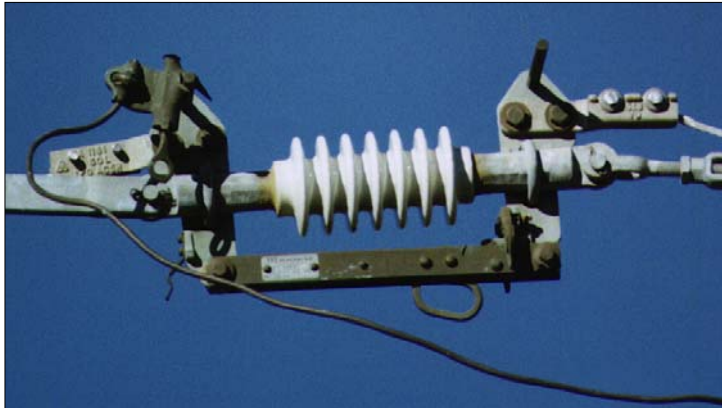
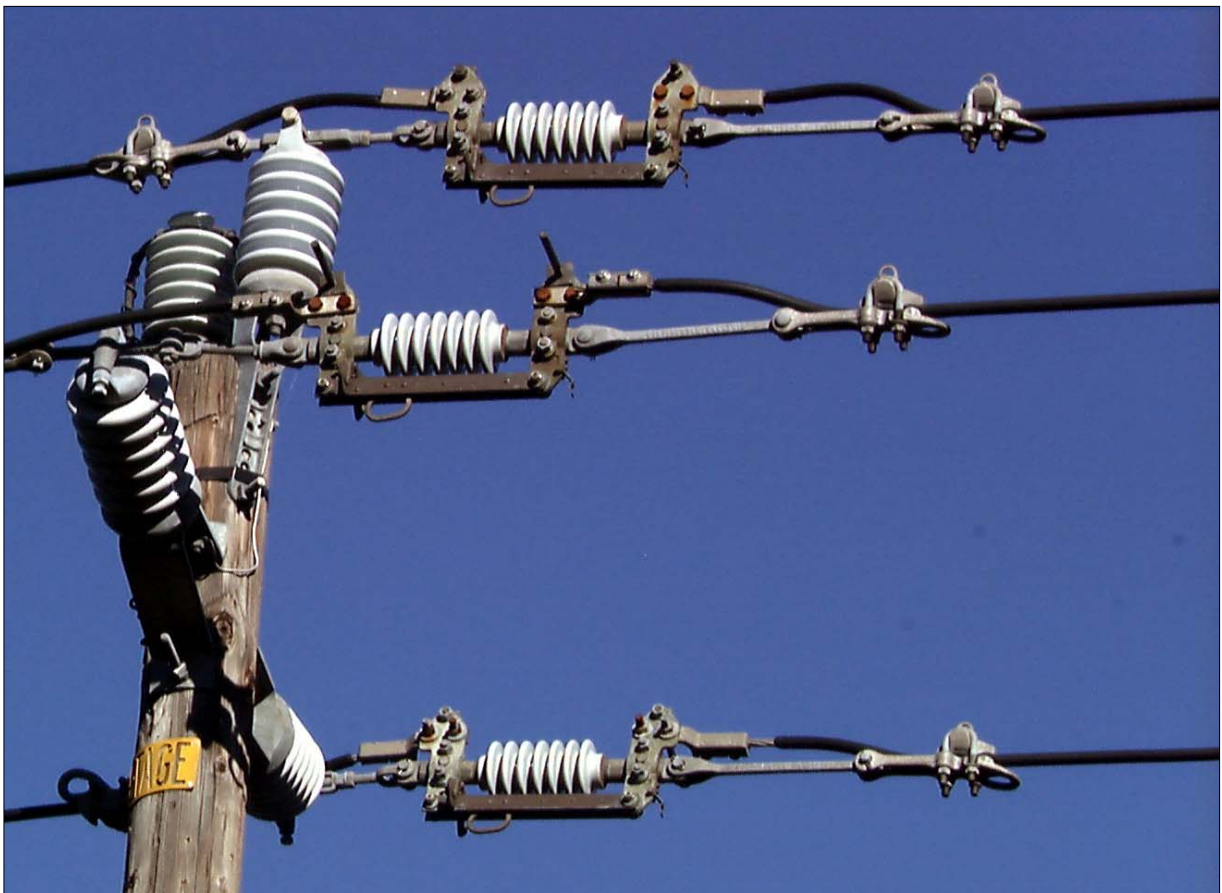

Figure 2-12
In-Line Disconnect (closed position)

Figure 2-13
In-Line Disconnects (closed position)



**Note: In-Line Disconnects are exempt under certain conditions.
See pages 3-13, 3-14 and 3-15.**

In-Line Disconnect

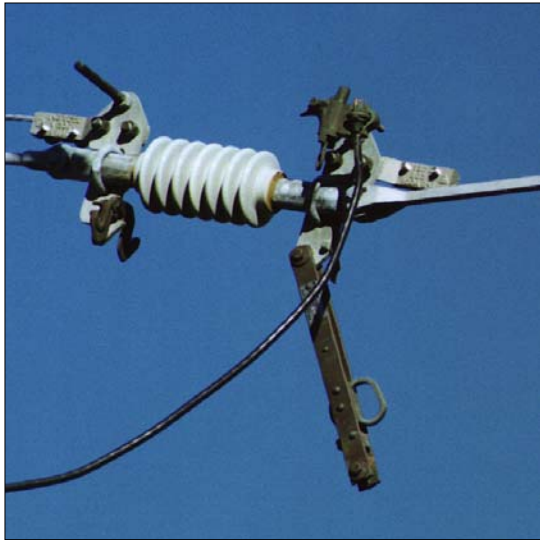
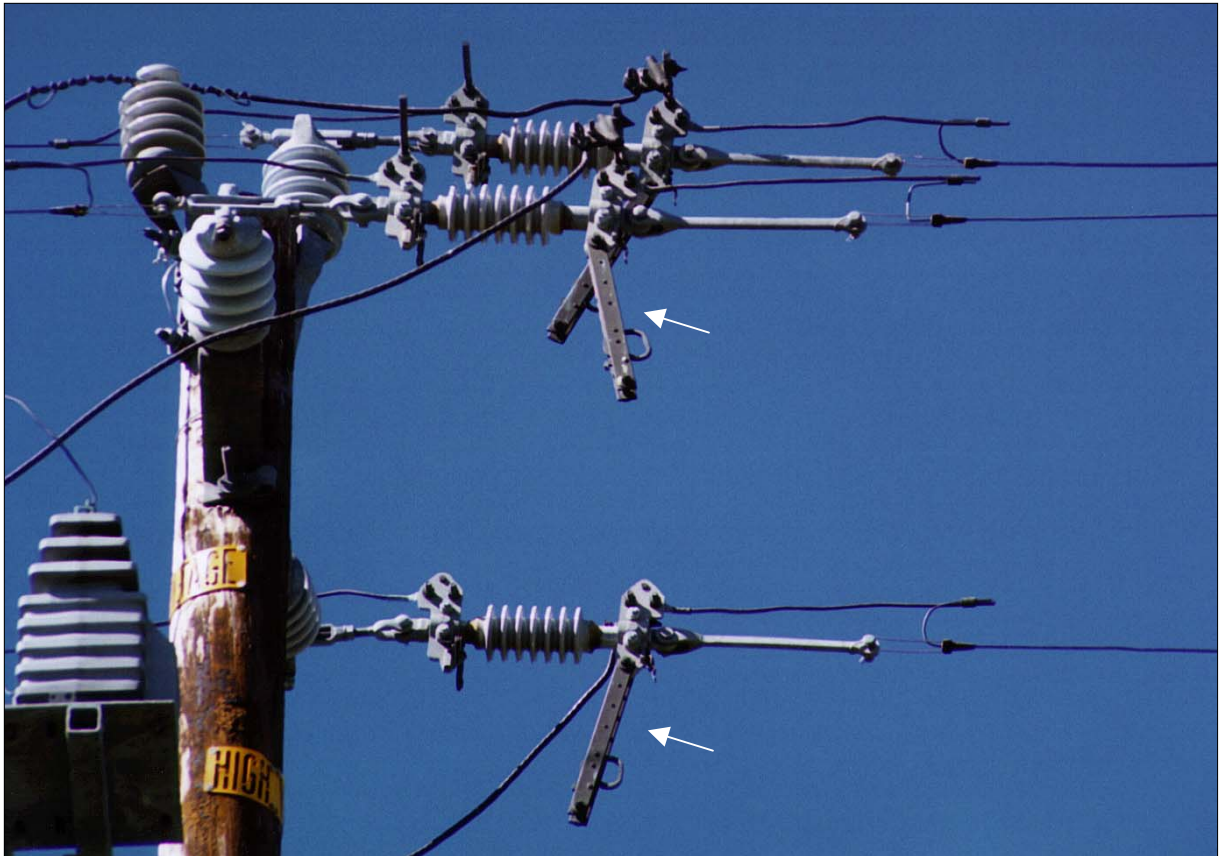

Figure 2-14
In-Line Disconnect (open position)

Note: In-Line Disconnects are exempt under certain conditions. See pages 3-13, 3-14 and 3-15.

Figure 2-15
In-Line Disconnects (open position)



Lightning Arrester



Figure 2-16
Arm Mounted Lightning Arrester (with Cable Riser and Universal Fuses)

Figure 2-17
Lightning Arrester (with Recloser)



Lightning Arrester

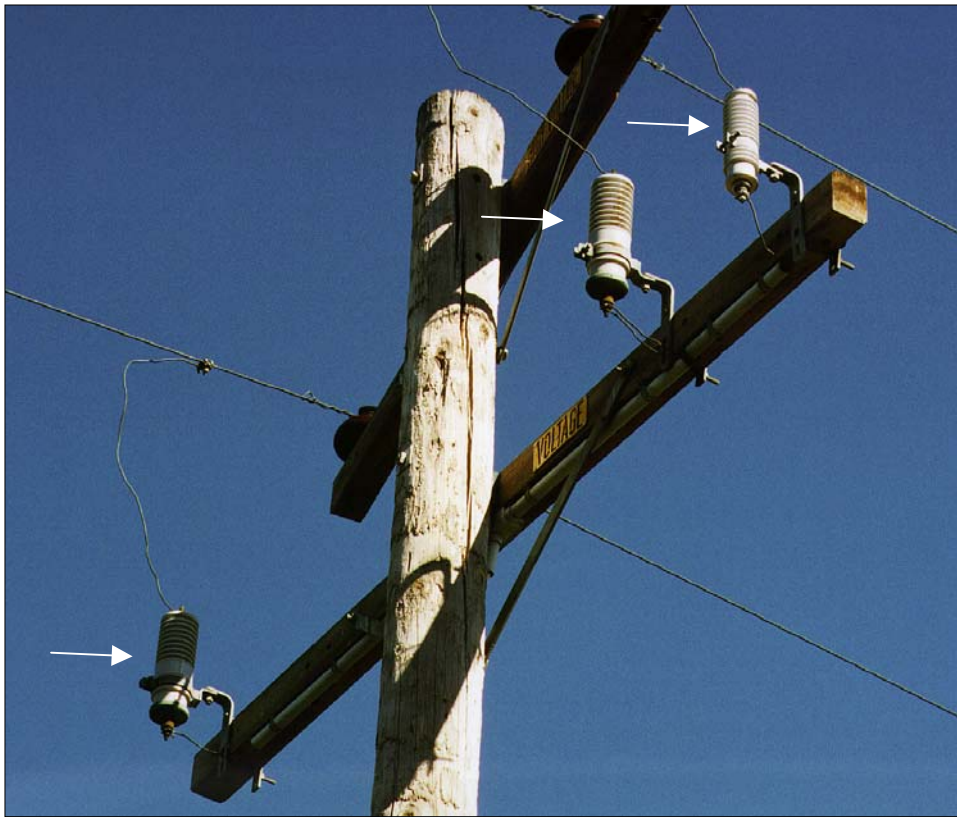
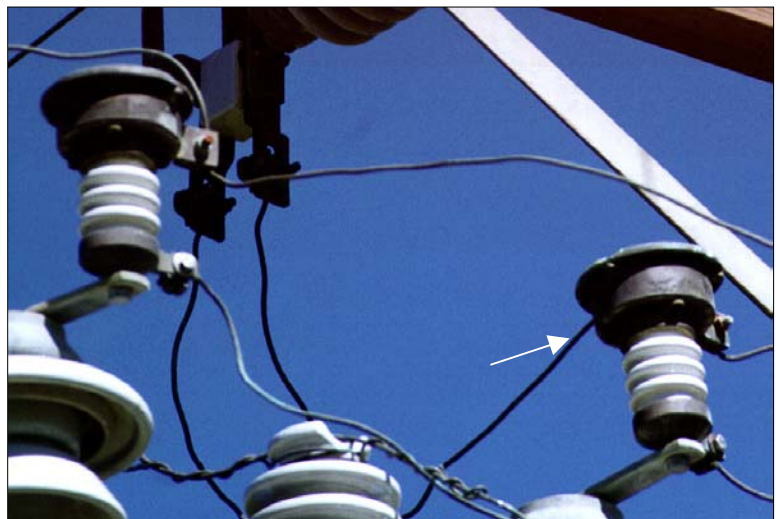

Figure 2-18
Lightning Arrester

Figure 2-19
Lightning Arrester



Non-Porcelain Lightning Arrester



Figure 2-20
Non-Porcelain Lightning Arrester

Figure 2-21
Non-Porcelain Lightning Arrester

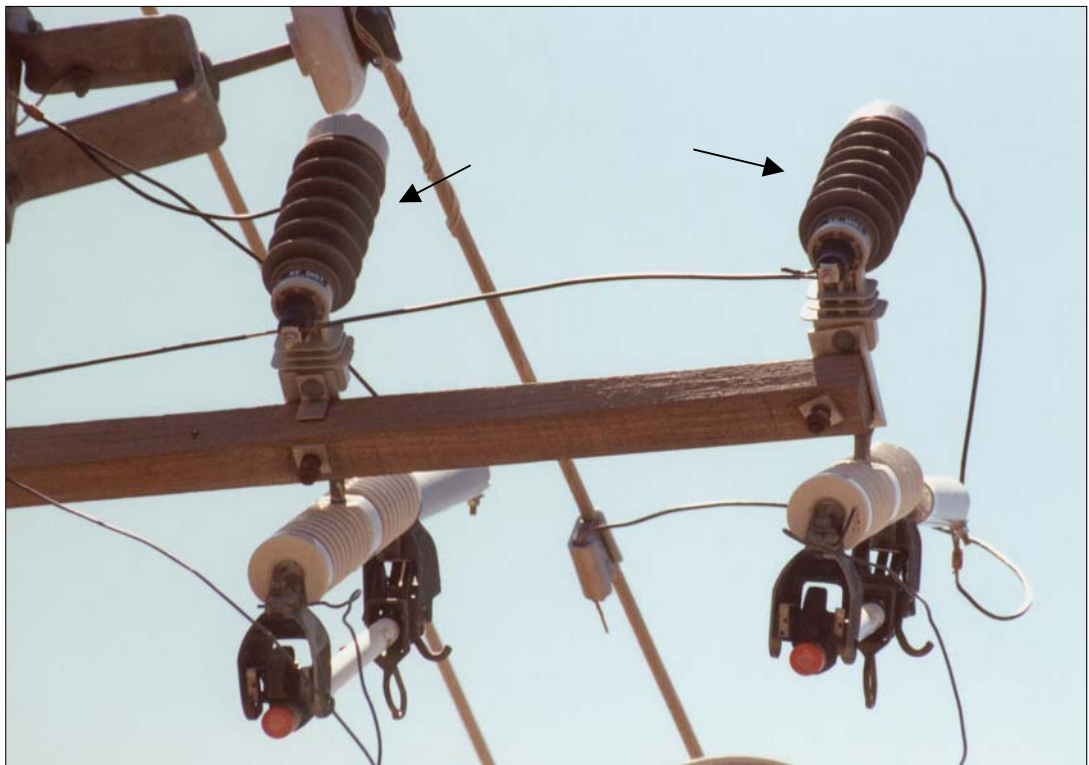

Lightning Arrester

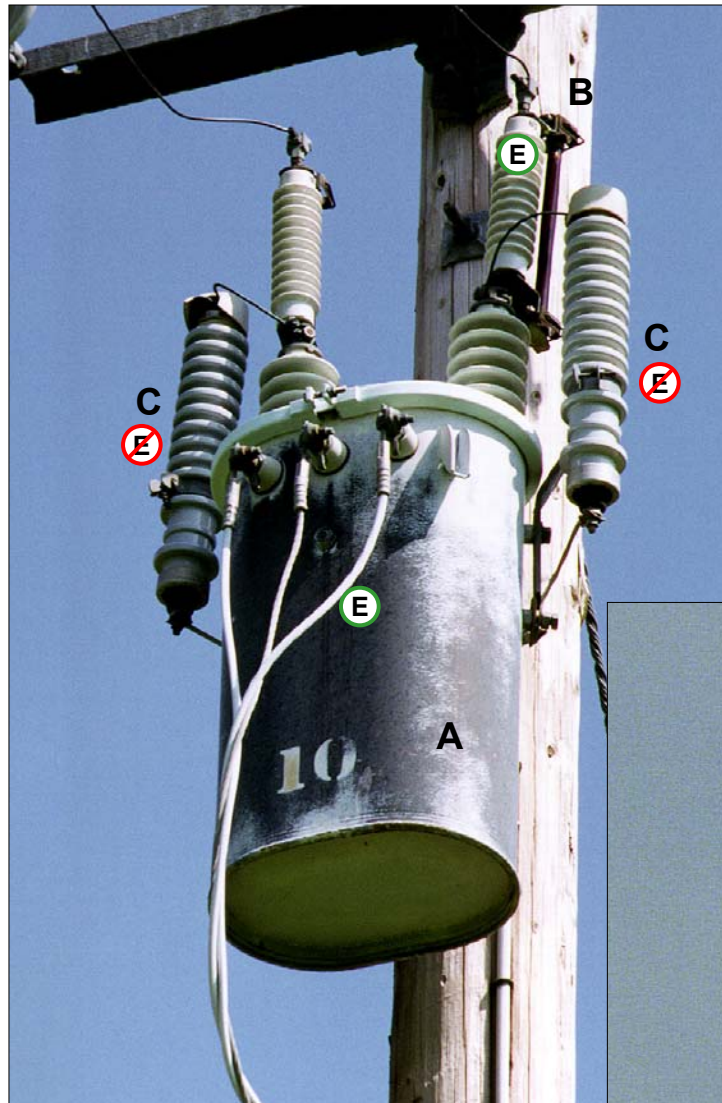

Figure 2-22
Transformer Mounted Lightning Arrester
A. Conventional Transformer (E)
B. Bushing Mounted Liquid Filled Fuse (E)
C. Lightning Arresters (E)

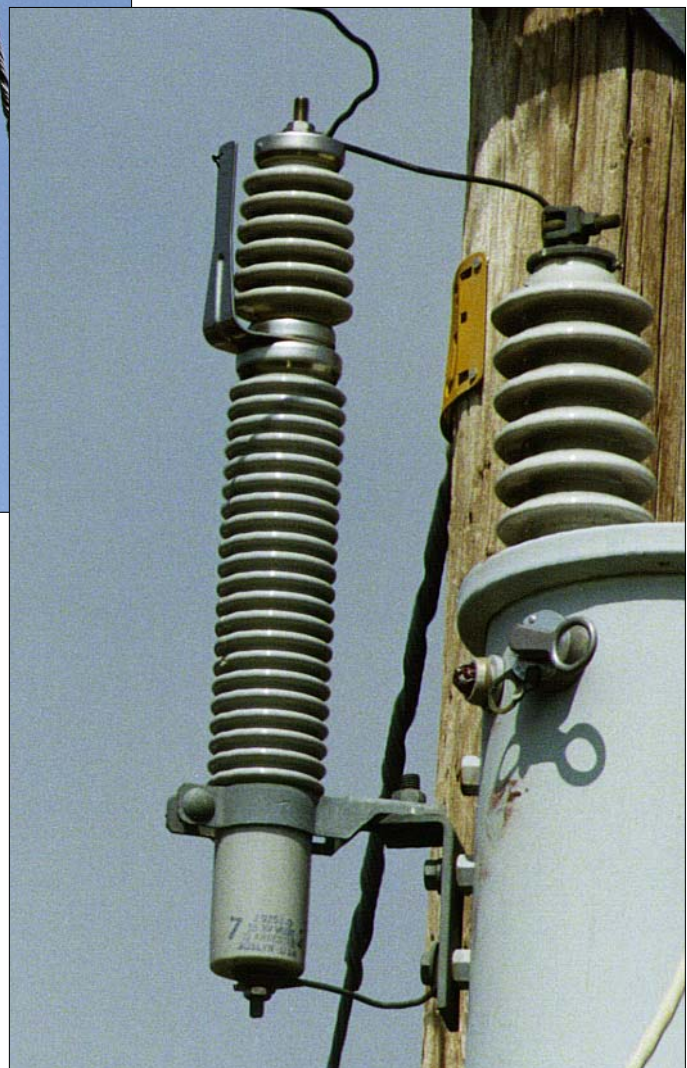

Figure 2-23
Gapped Lightning Arrester

Lightning Arrester



Figure 2-24
Lightning Arrester

Figure 2-25
Lightning Arrester



Hot Tap Clamp



Figure 2-26
Hot Tap Clamps



Compare with exempt hot tap clamps on page 3-20



Note: Some Hot Tap Clamps are exempt. See page 3-20.

Split Bolt Connector



Figure 2-27
Split Bolt Connectors (various sizes)

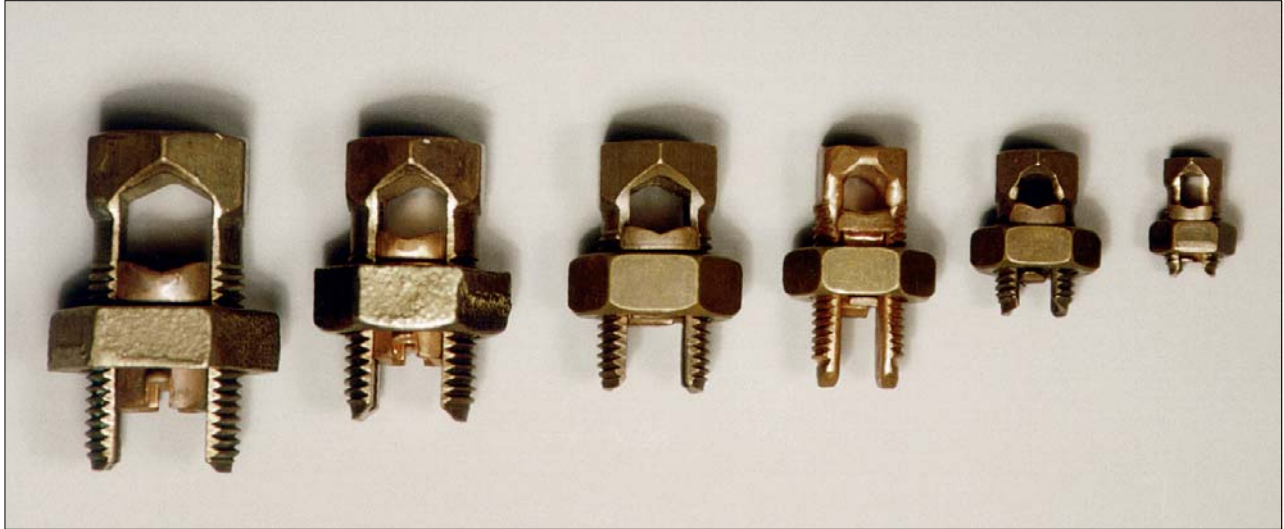
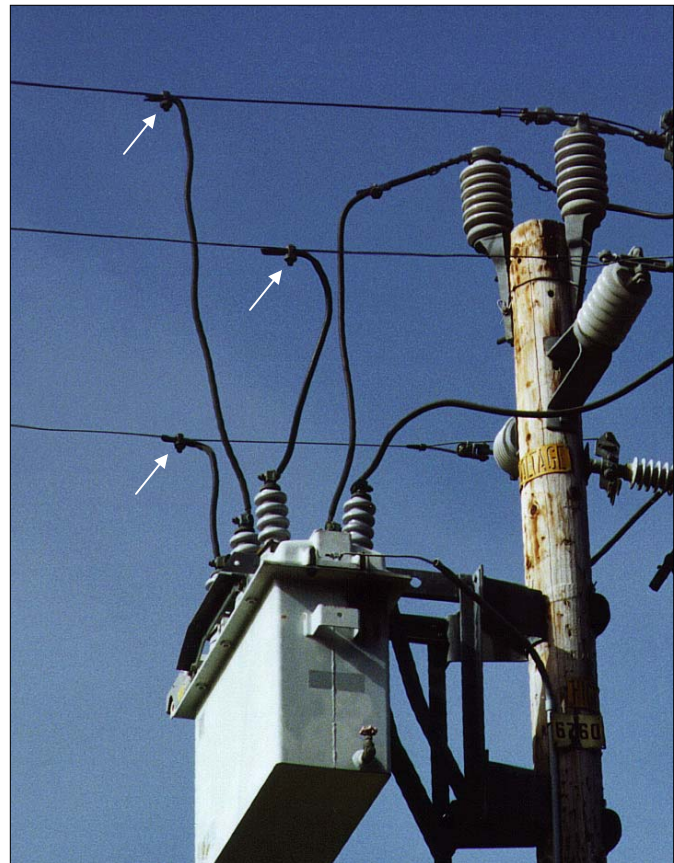
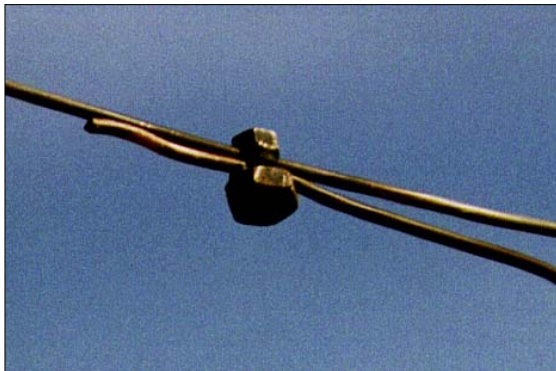

Figure 2-28
Split Bolt Connector



Note: Under certain conditions, split bolts are exempt. See page 3-22.

Other Connectors

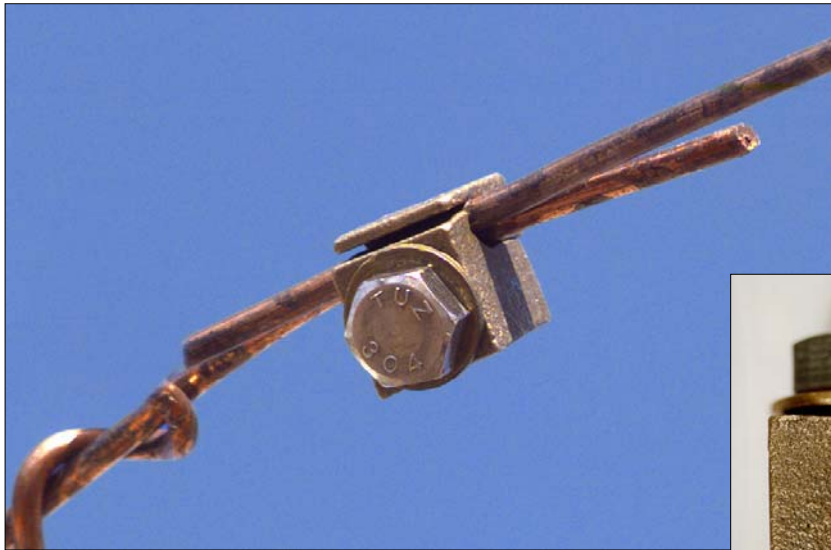

Figure 2-29
Fargo Connector



Figure 2-30
LM Connector



Grasshopper Air Switch



Figure 2-31
Grasshopper Air Switch (closed position)

Figure 2-32
Grasshopper Air Switch (open position)

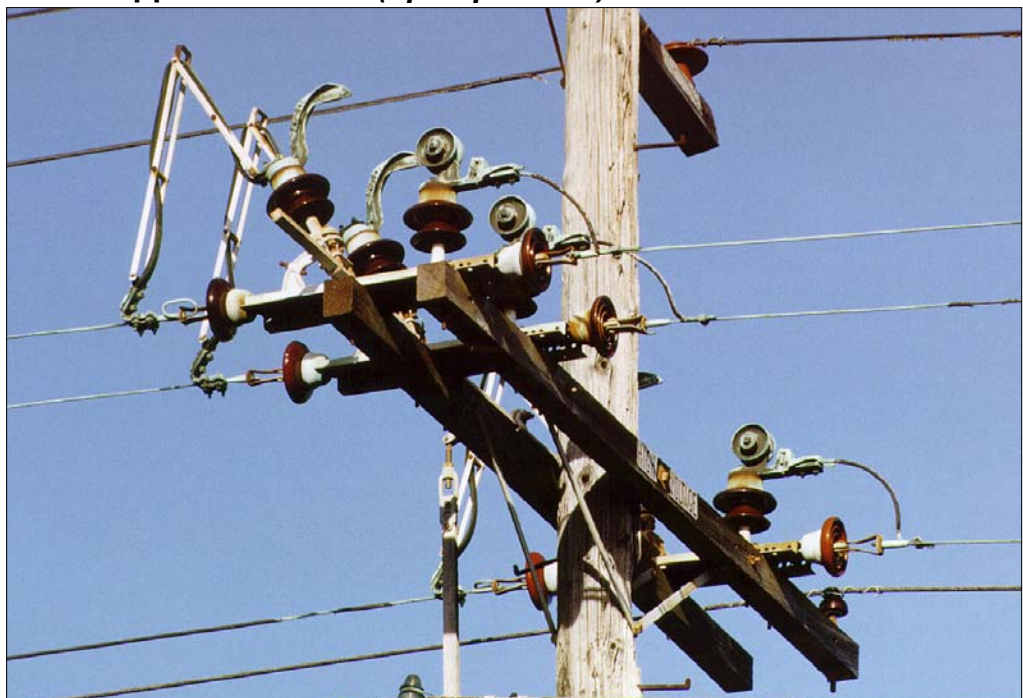

Transmission Air Switch

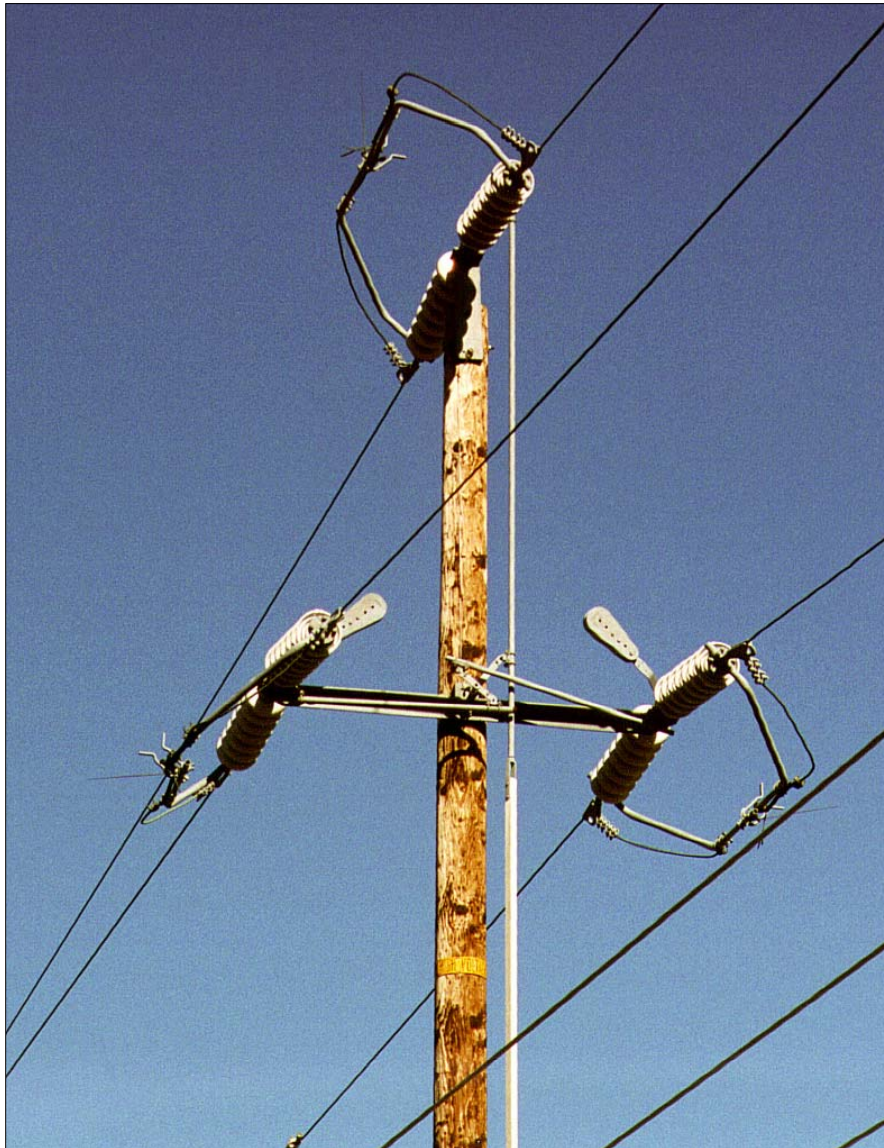

Figure 2-33
Transmission Air Switch, Pole Mounted 60kV (closed position)

Transmission Air Switch



Figure 2-34

Transmission Air Switches

A. Tower Mounted (*closed position*)

B. Pole Mounted (*closed position*)

C. Tower Mounted (*open position*)





Section 3 Exempt

Clearance Not Required

Non-Expulsion Fuse



Figure 3-1
**Arm Mounted Cutout with
Non-Expulsion Fuse**



Figure 3-2
**Arm Mounted Cutout with
Non-Expulsion Fuse**

Figure 3-3
Arm Mounted Cutout with Non-Expulsion Fuses



Non-Expulsion Fuse

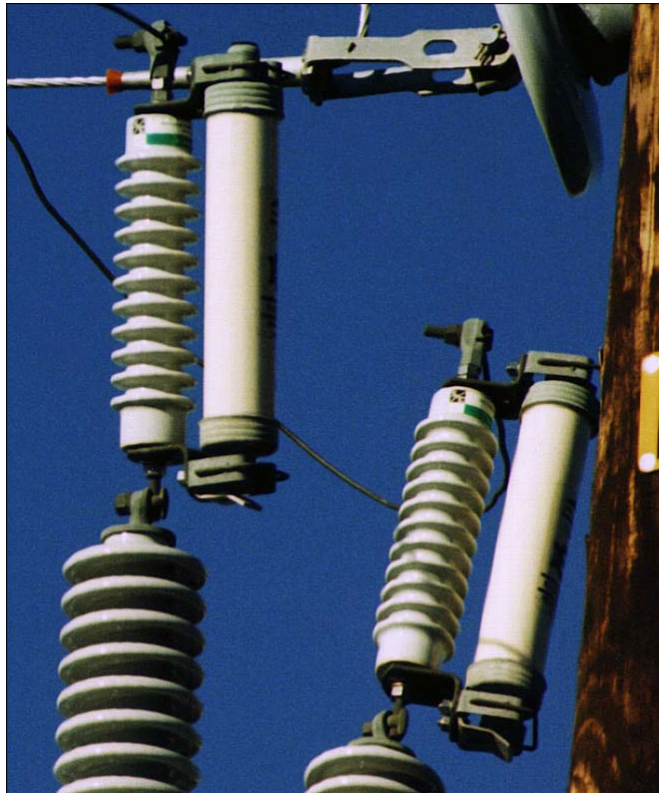

Figure 3.4
**Bushing Mounted Cutout
with Non-Expulsion Fuse**

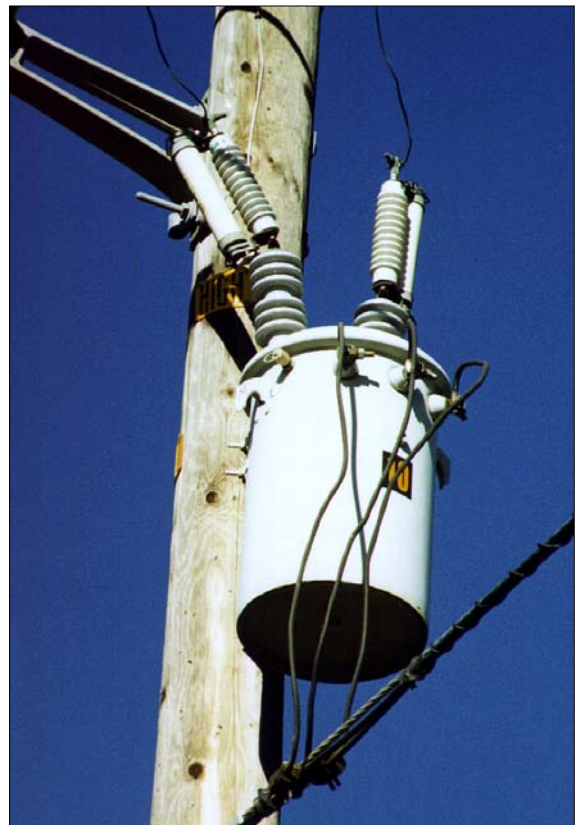
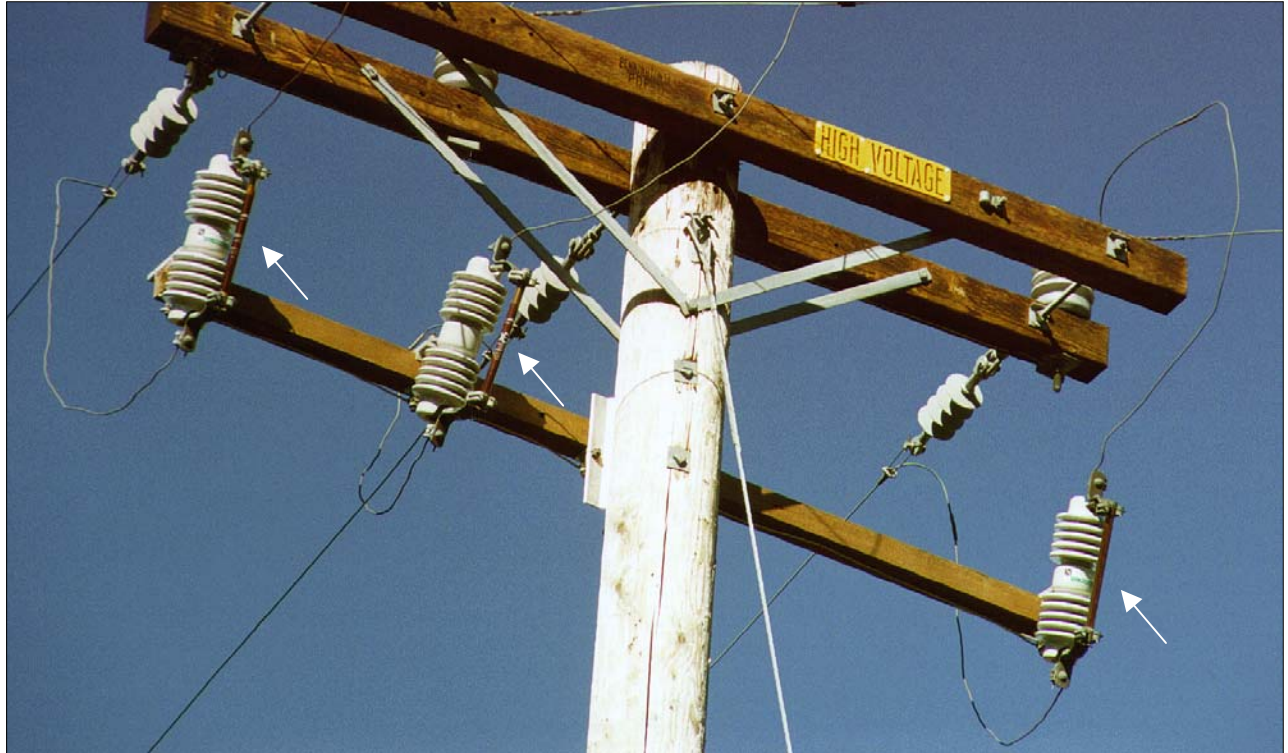

Figure 3-5
**Bushing Mounted Cutout
with Non-Expulsion Fuses**

Liquid Filled Fuse



Figure 3-6
Arm Mounted Cutout with Liquid Filled Fuse



Liquid Filled Fuse

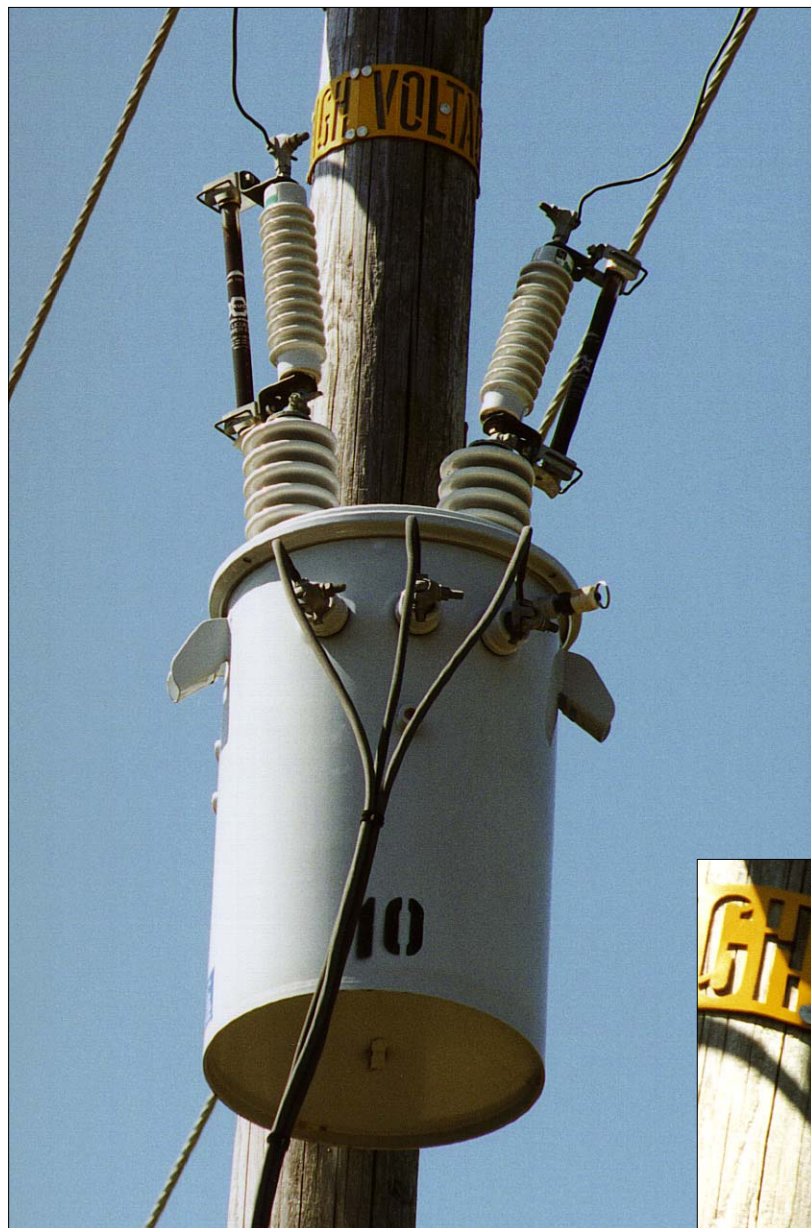

Figure 3-7
Bushing Mounted Cutout with Liquid Filled Fuse

SMU-20 Fuse



Figure 3-8
Arm Mounted Cutout with SMU-20 Fuses

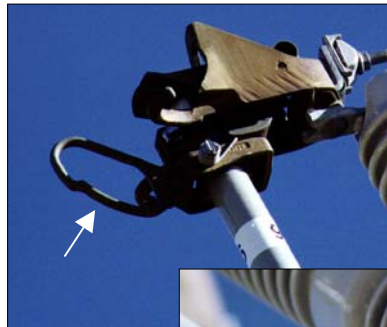
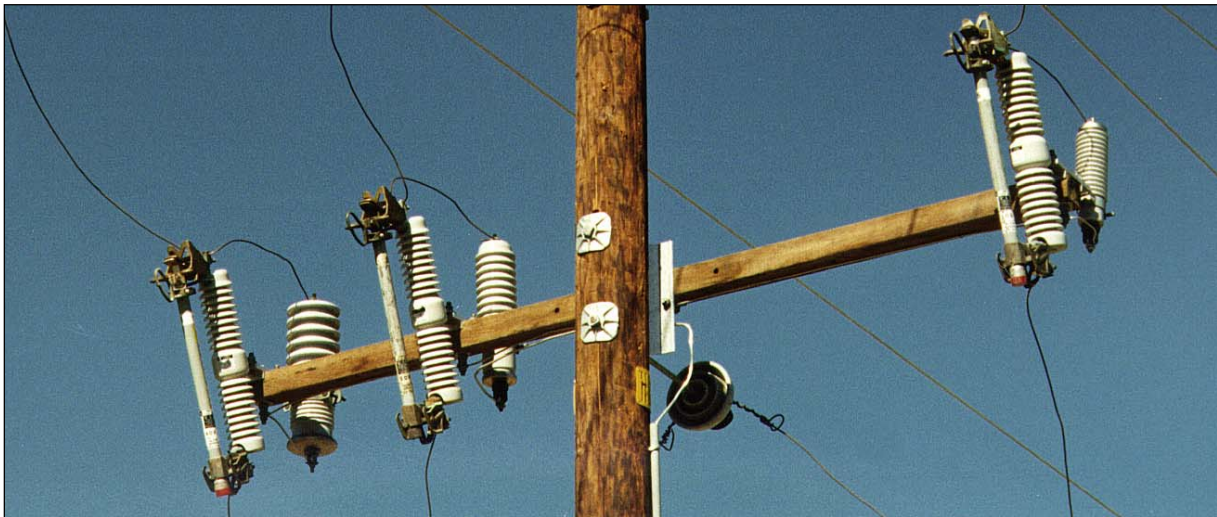

Figure 3-9
SMU-20 Fuse - Detail

Figure 3-10
Arm Mounted Cutout with SMU-20 Fuses



S&C Fault Tamer Fuse



Figure 3-11
**Arm Mounted Cutout with
S&C Fault Tamer Fuse**



600 Amp KPF Air Switch



Figure 3-12
600 Amp KPF Air Switch, Triangular Construction (closed position)



Figure 3-13
600 Amp KPF Air Switch, Triangular Construction (open position)

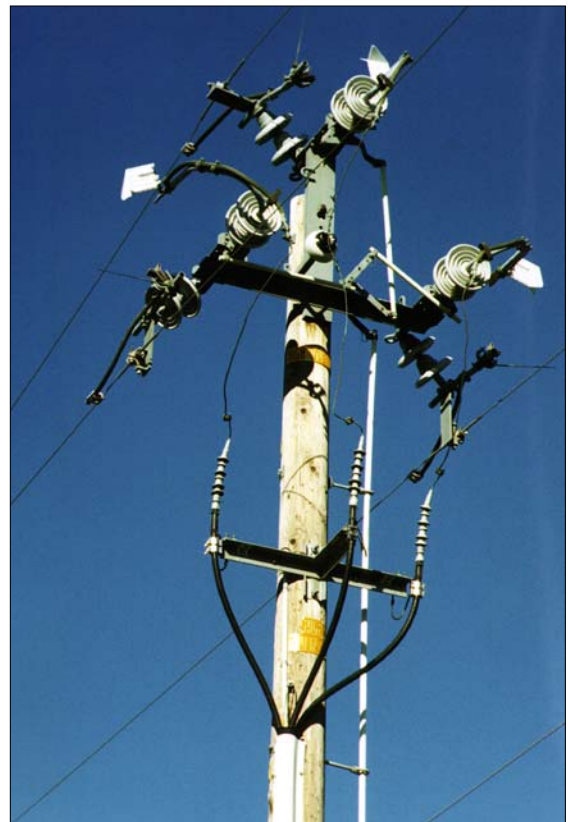

Note: Exemption does not apply in SDG&E's Service Territory



600 Amp KPF air Switch



Figure 3-14
600 Amp KPF Air Switch, Crossarm Construction (closed position)
With Arcing Horns and Snuffers

Note: Exemption does not apply in SDG&E's Service Territory



Figure 3-15
600 Amp KPF Air Switch, Crossarm Construction (closed position)
Without Arcing Horns or Snuffers



Underarm Sidebreak Switch



Figure 3-16
**600 Amp Underarm Sidebreak Switch
(open position)**



Figure 3-17
**600 Amp Underarm Sidebreak Switch
(closed position)**



S&C Underarm Side-Break Switch



Figure 3-18
S&C Underarm Side-Break Switch
(closed position)



Figure 3-19
S&C Underarm Side-Break Switch
(closed position)

S&C Omni-Ruptor Switch



Figure 3-20
S&C Omni-Ruptor Switch, Triangular Construction (open position)

Figure 3-21
S&C Omni-Ruptor Switch, Tangent Construction (closed position)



Note: Upright version of Underarm Sidebreak Switch

S&C Scada-Mate Switch



Figure 3-22
S&C Scada-Mate Switch



Open Position
Indicator Green
Letter "O" visible



Closed Position
Indicator Red
Letter "C" visible

Recloser

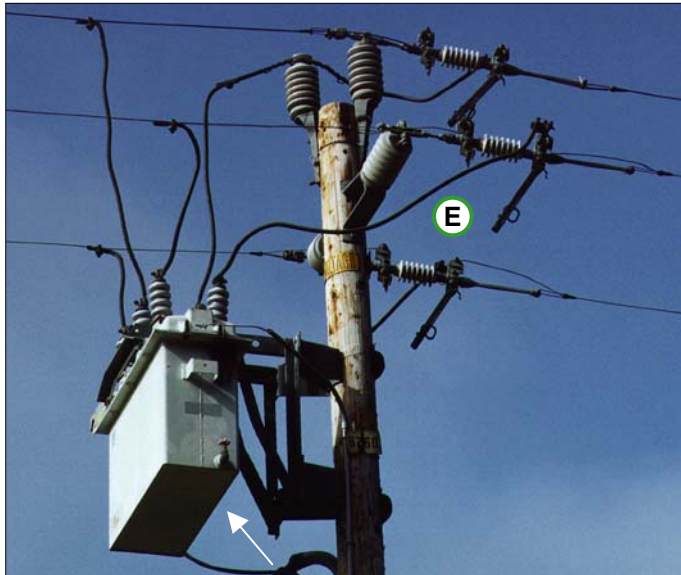
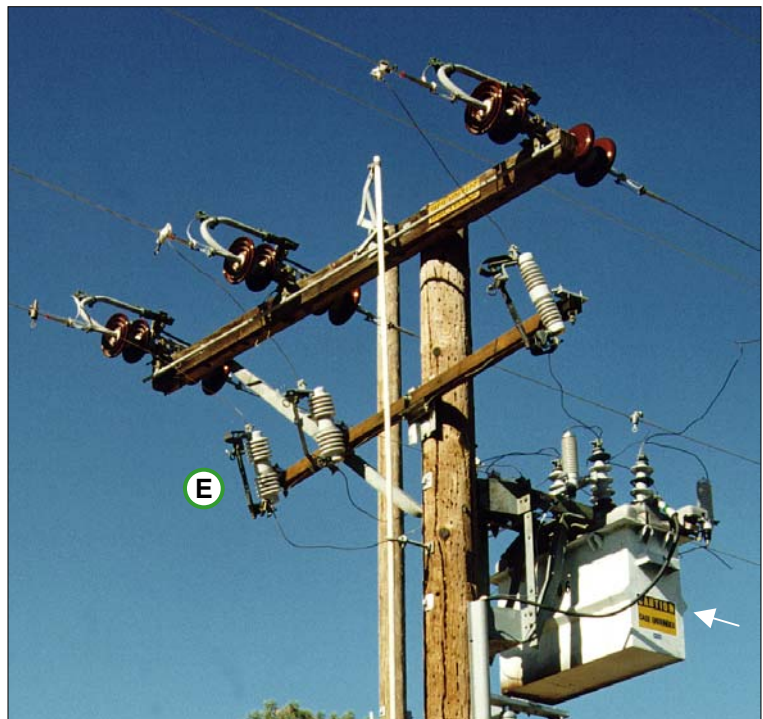

Figure 3-23
Recloser with In-Line Disconnects
(open position)

Figure 3-24
Recloser with Solid Blade Disconnects
(closed position)



Note: Only when used with Reclosers, Sectionalizers (page 3-14) or Voltage Regulators (page 3-15), **In-Line Disconnects** and **Solid Blade Disconnects** are exempt

Sectionalizer

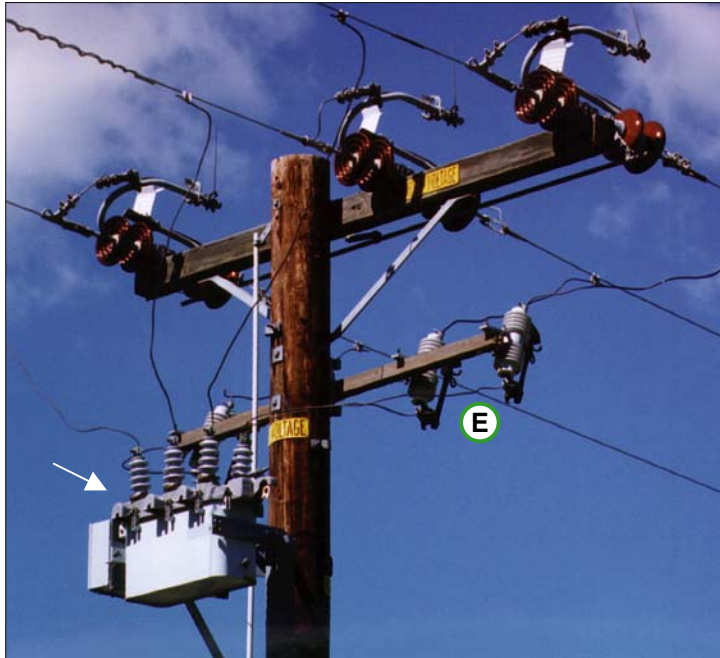

Figure 3-25
Sectionalizer with Solid
Blade Disconnects

Figure 3-26
Sectionalizer



Note: Only when used with Reclosers (page 3-13), Sectionalizers or Voltage Regulators (page 3-15), **In-Line Disconnects** and **Solid Blade Disconnects** are exempt

Voltage Regulator

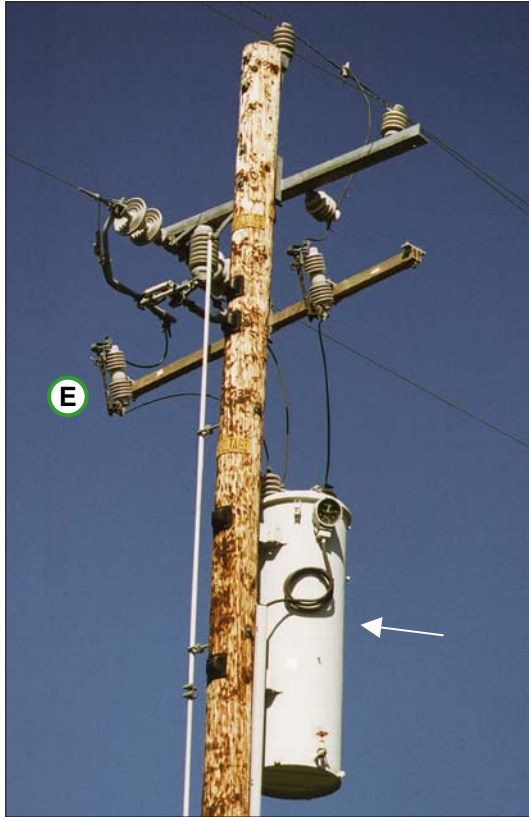

Figure 3-27
Voltage Regulator with Solid Blade Disconnects

Figure 3-28
Voltage Regulator



Note: Only when used with Reclosers (page 3-13), Sectionalizers (page 3-14) or Voltage Regulators, **In-Line Disconnects** and **Solid Blade Disconnects** are exempt

Capacitor Bank



Figure 3-29
Capacitor Bank



Transformer

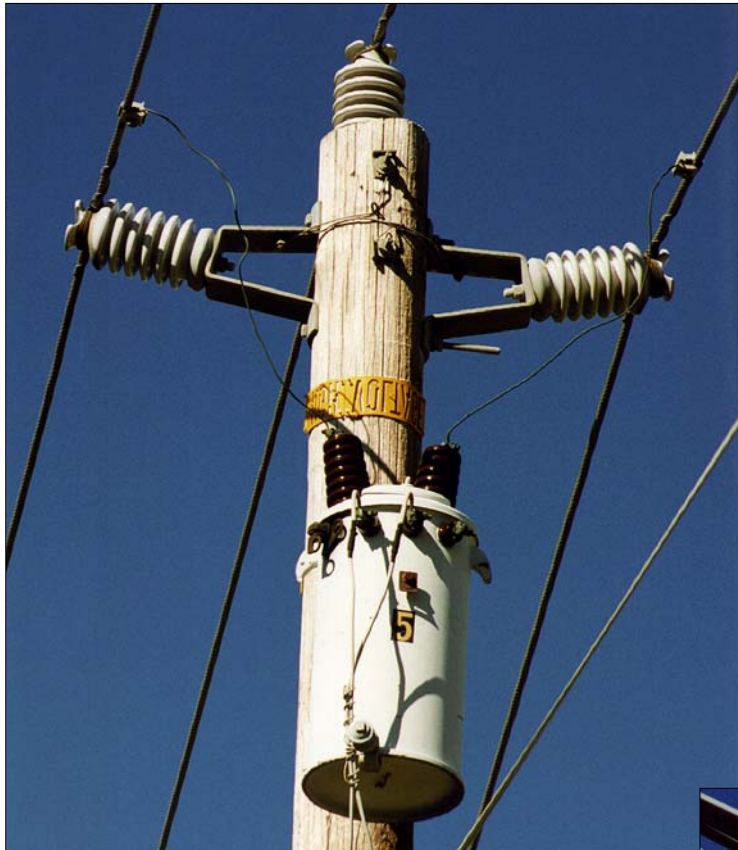
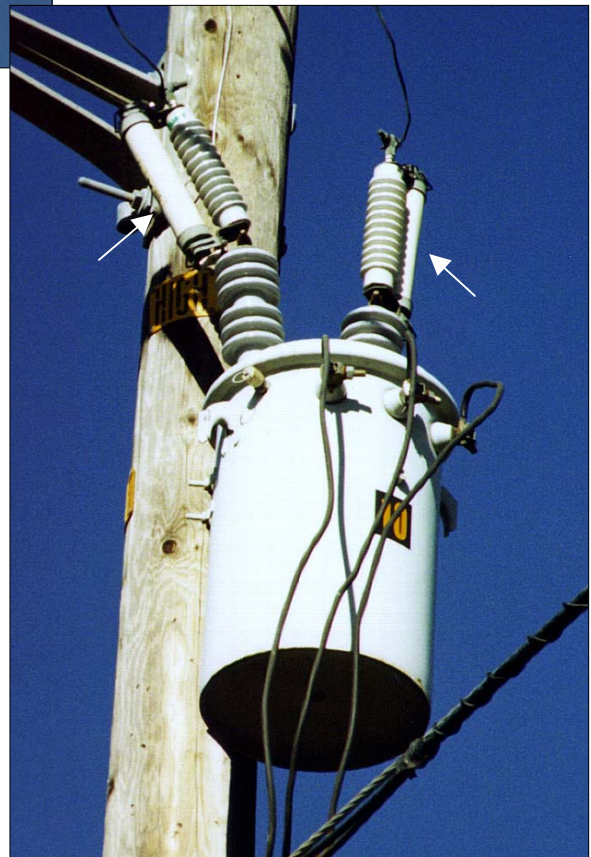

Figure 3-30
**Self-Protected
Transformer (no external
cutouts or fuses)**

Figure 3-31
**Conventional Transformer with
Exempt Fuses**



Parallel Groove Connectors



Figure 3-32
Parallel Groove Connectors



Figure 3-33
Parallel Groove Connectors - Copper



Parallel Groove Connectors

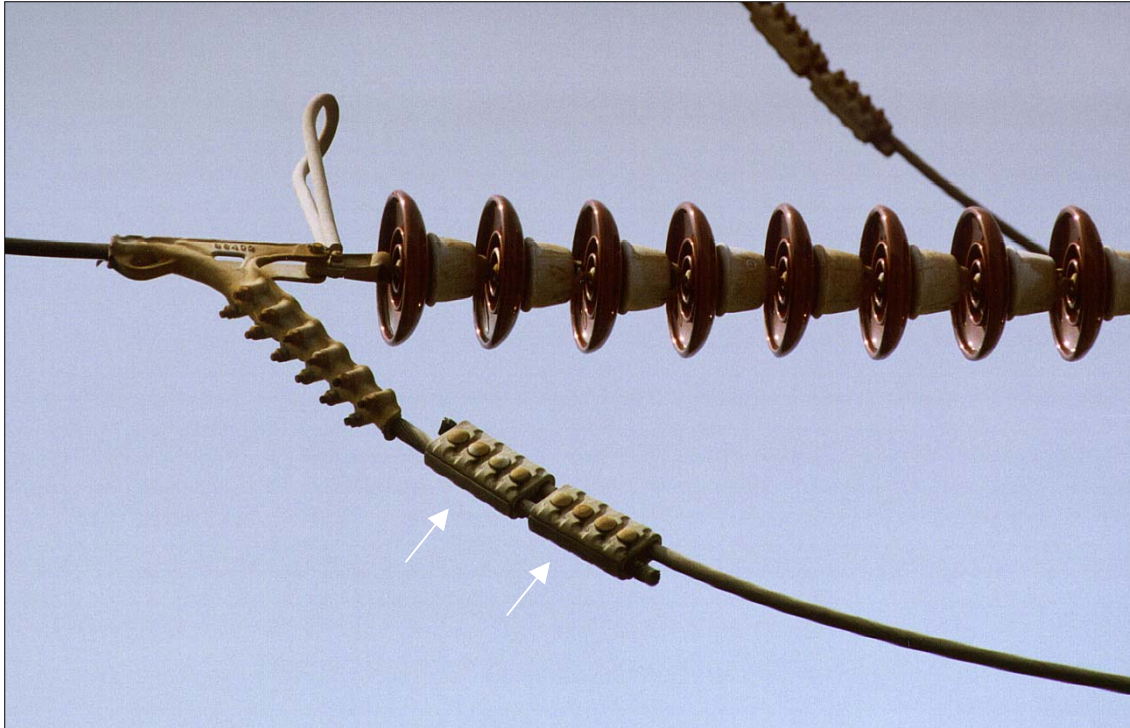
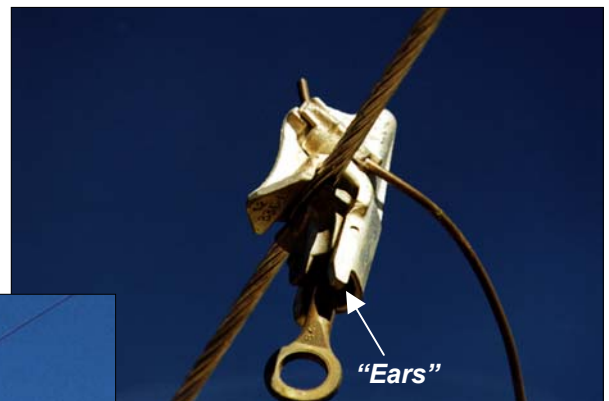

Figure 3-34
Transmission Deadend with Parallel Groove Connectors

Hot Tap Clamp



Figure 3-35
Hot Tap Clamps



Compare with non-exempt
hot tap clamps on page 2-15

Note: Some Hot Tap Clamps are non-exempt. See page 2-15

Piercing Tap Clamp

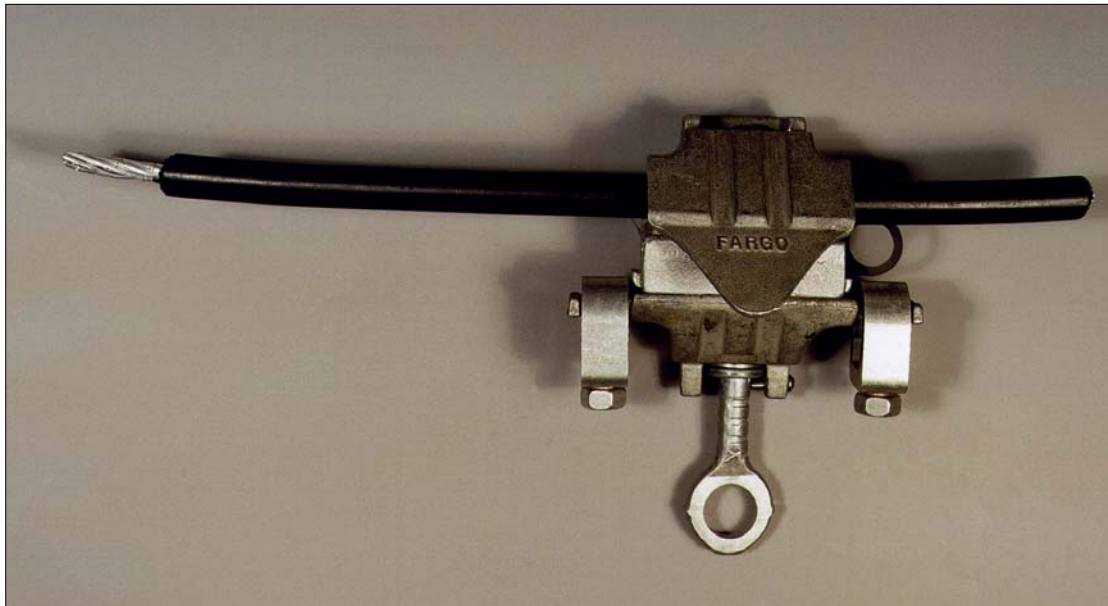

Figure 3-36
Piercing Hot Tap Clamp on Tree Wire

Figure 3-37
Piercing Hot Tap Clamp - Detail



Idle Split Bolt Connectors



Figure 3-38
Idle Split Bolt Connectors

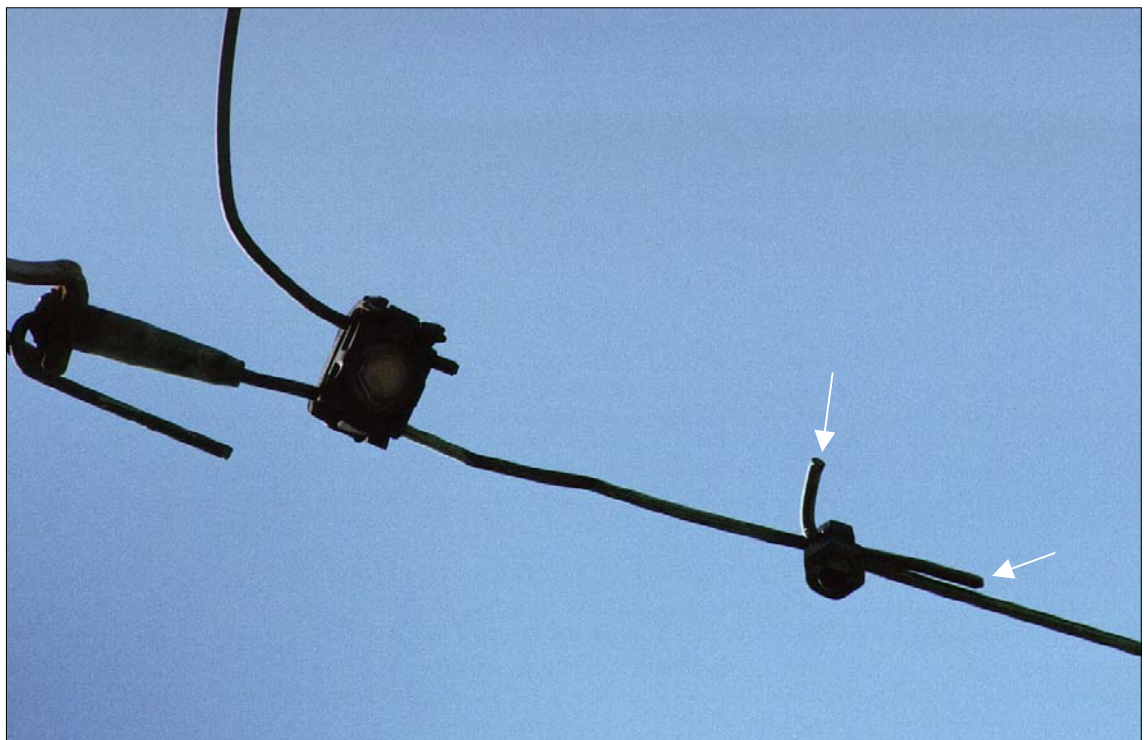

Note: Split bolts are ONLY exempt when idle on the line. See page 2-16 for non-exempt split bolts.

Wedge Connectors



Figure 3-39
Bolted Wedge Connector

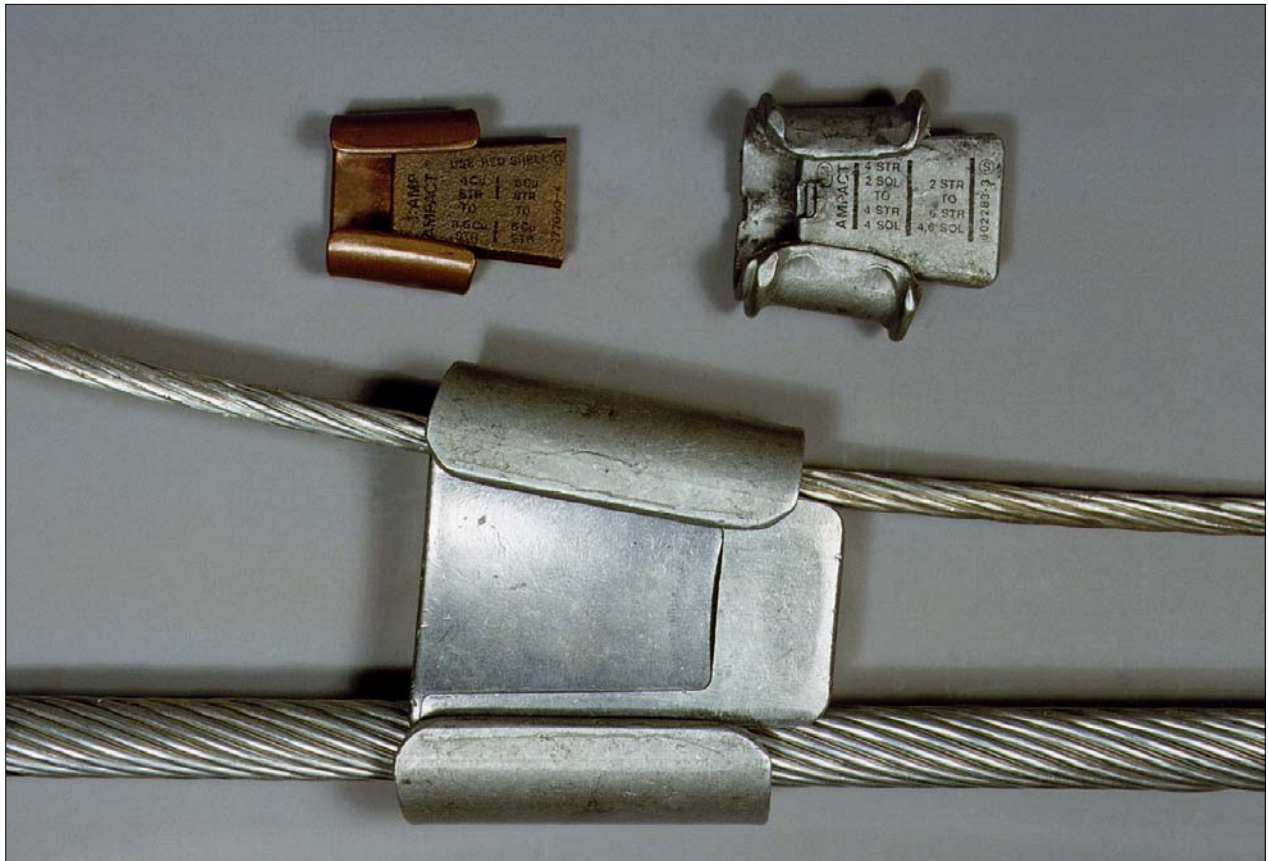

Figure 3-40
Fired Wedge Connectors

Compression Connectors



Figure 3-41
Compression Connectors

Bolted Flat Plate Connector

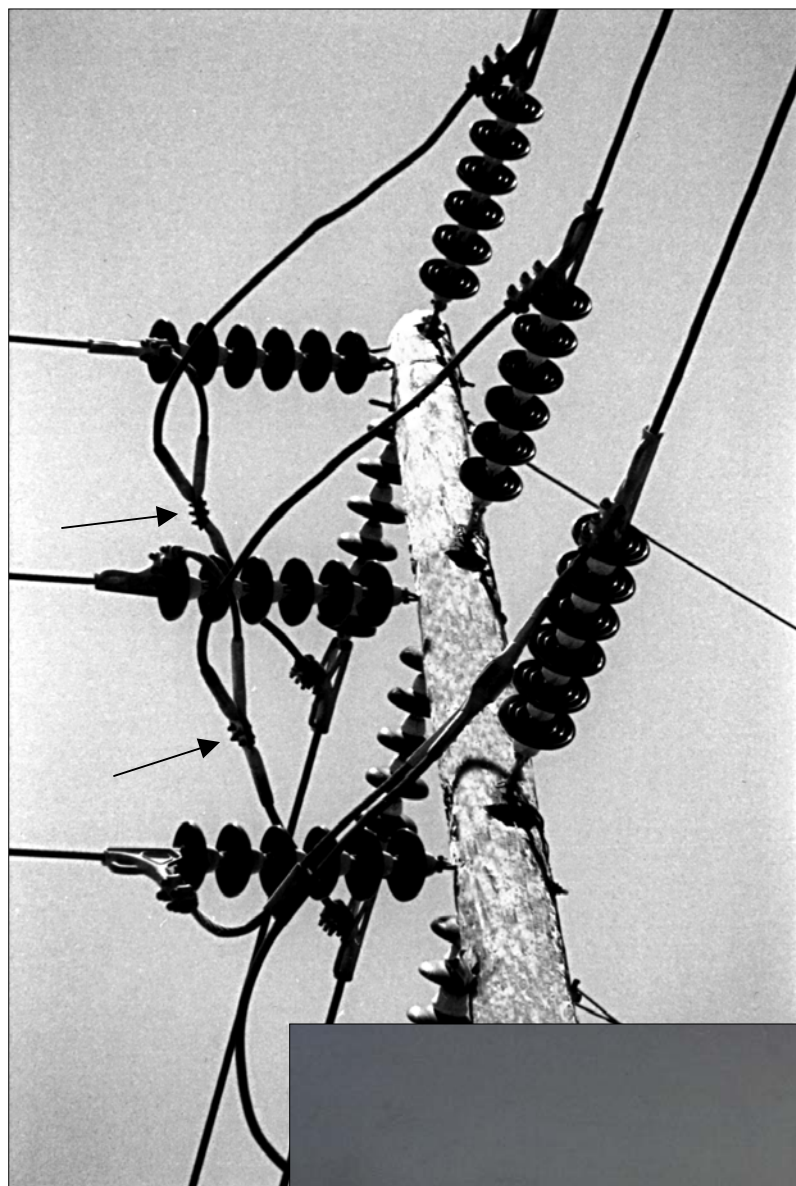

Figure 3-42
**Transmission Vertical
Deadend with Bolted Flat
Plate Connector**



Figure 3-43
Bolted Flat Plate Connector

Automatic Deadend



Figure 3-44
Automatic Deadends



Figure 3-45
Automatic Deadends with Suspension Insulators



Splices



Figure 3-46
Line Splices

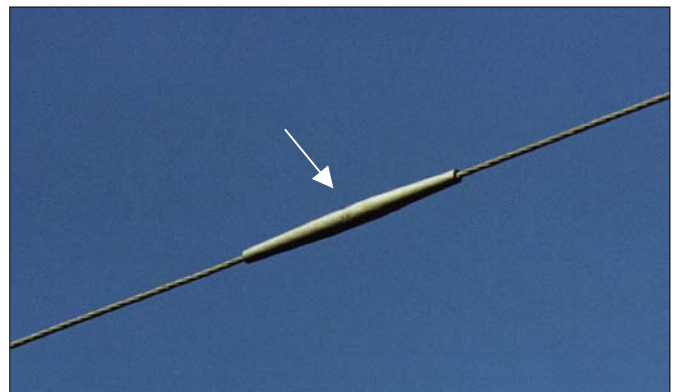

Figure 3-47
Automatic Line Splices



Section 4

Construction

Distribution Construction



Figure 4-1
Vertical Angle

Figure 4-2
Triangular

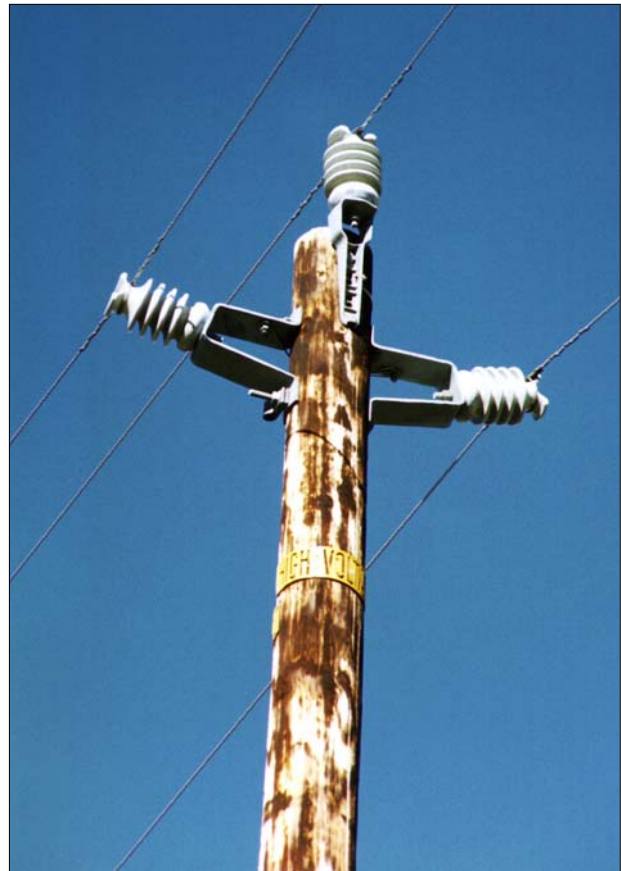

Distribution Construction

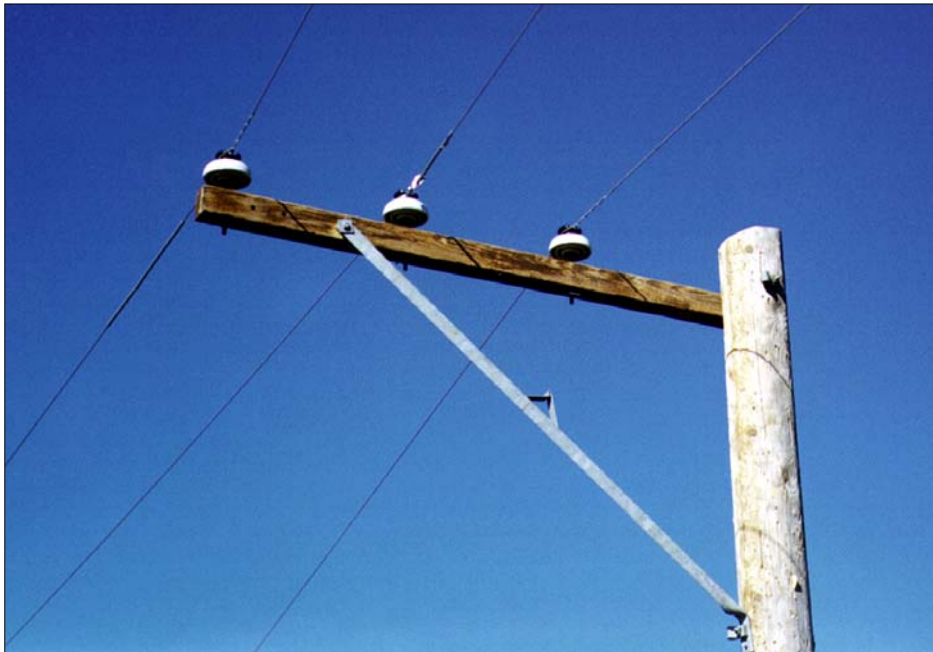

Figure 4-3
Alley Arm

Figure 4-4
Crossarm (Tangent)



Distribution Construction

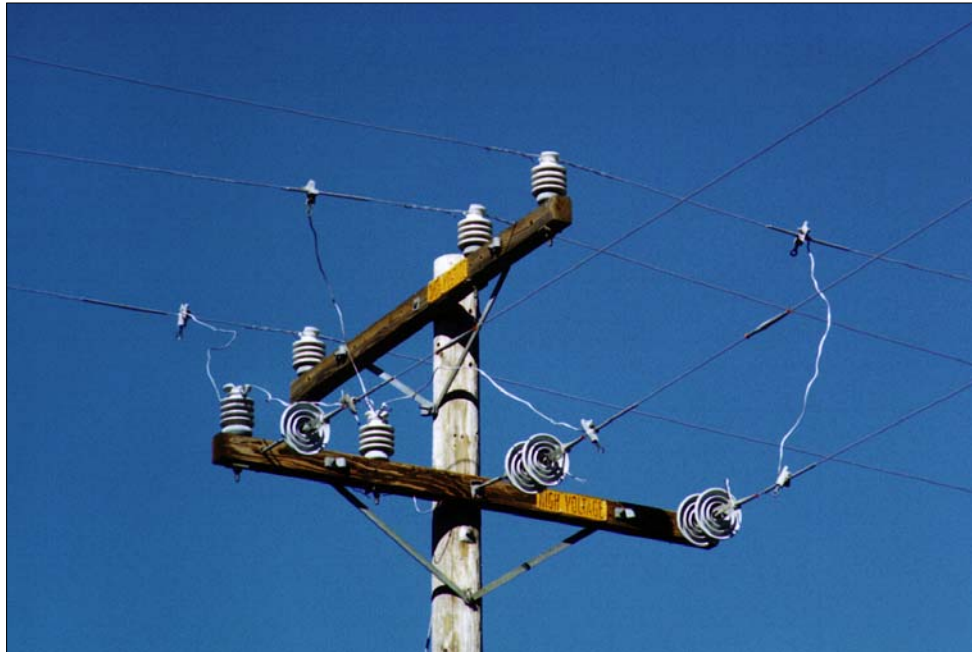
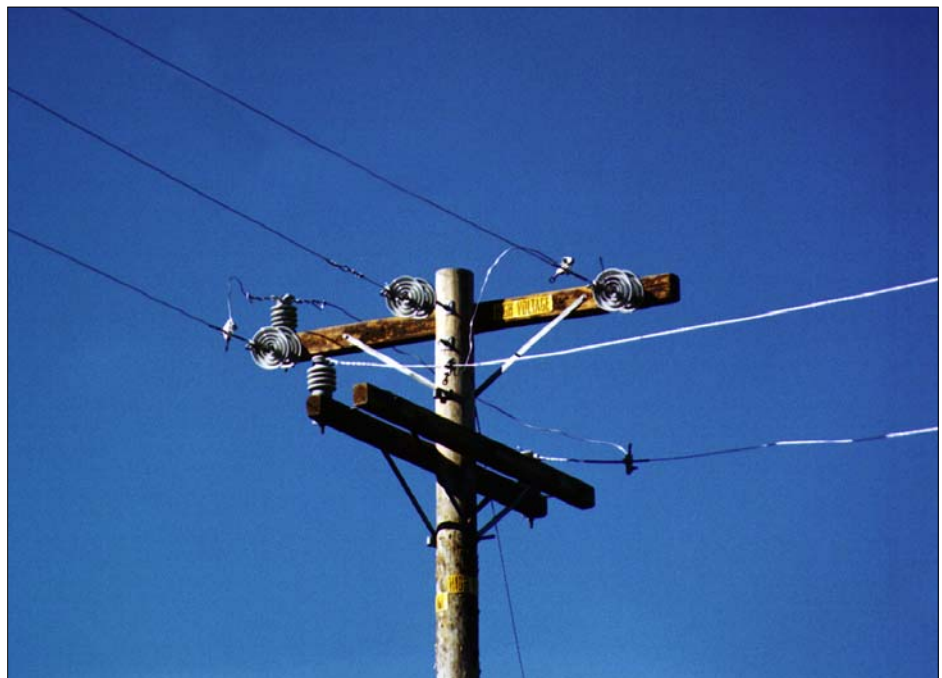

Figure 4-5
Tangent Crossarm with Deadend Tap (T-Tap)

Figure 4-6
Crossarm Deadend Corner (Line and Buck)



Distribution Construction

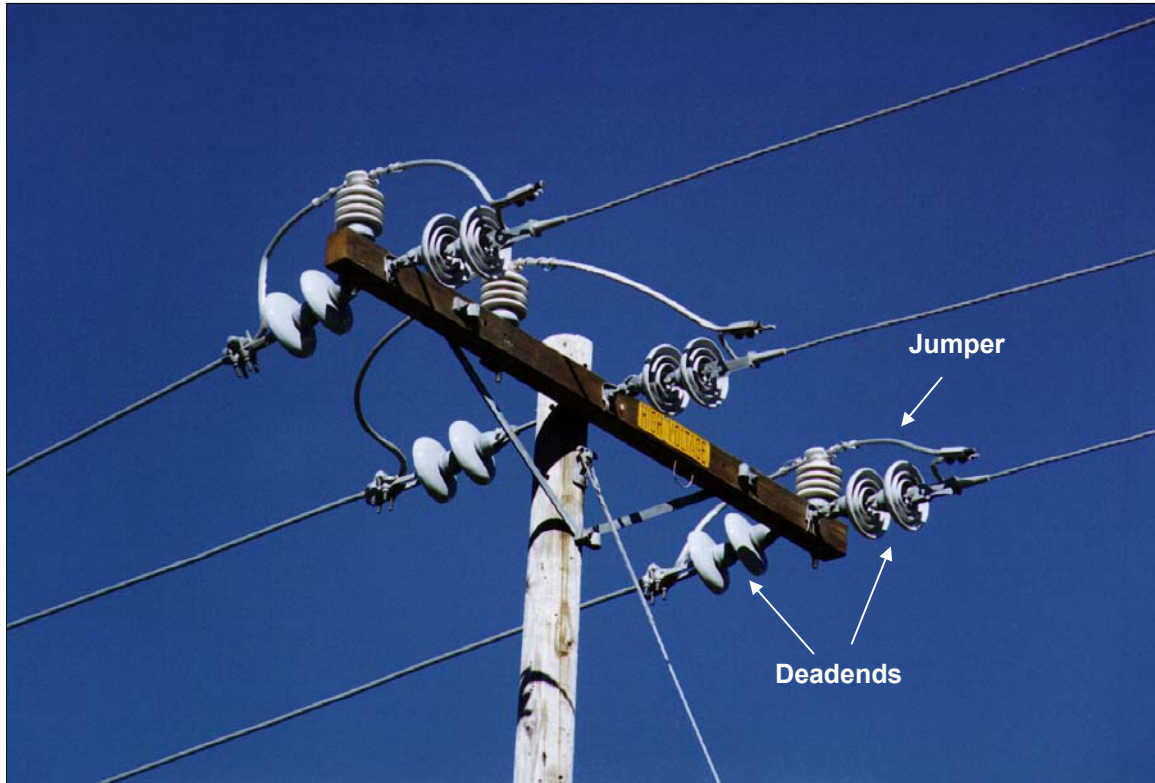
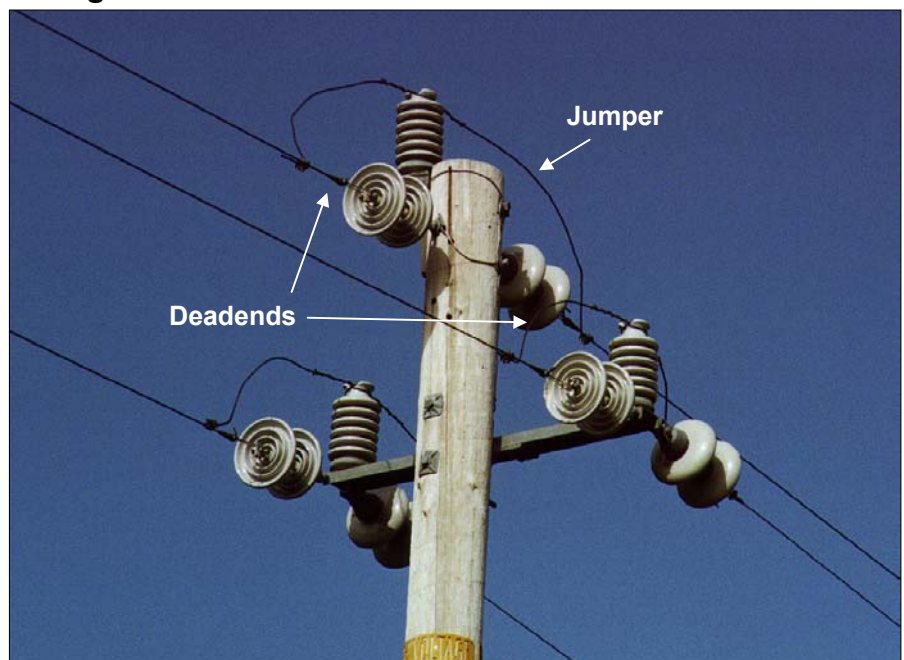

Figure 4-7
Crossarm Double Deadend

Figure 4-8
Triangular Double Deadend



Distribution Construction

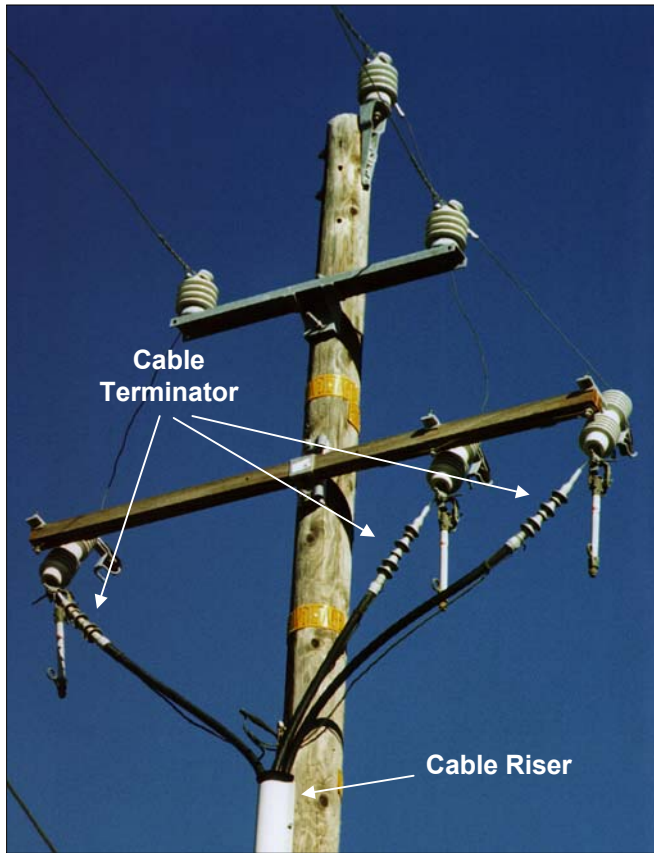
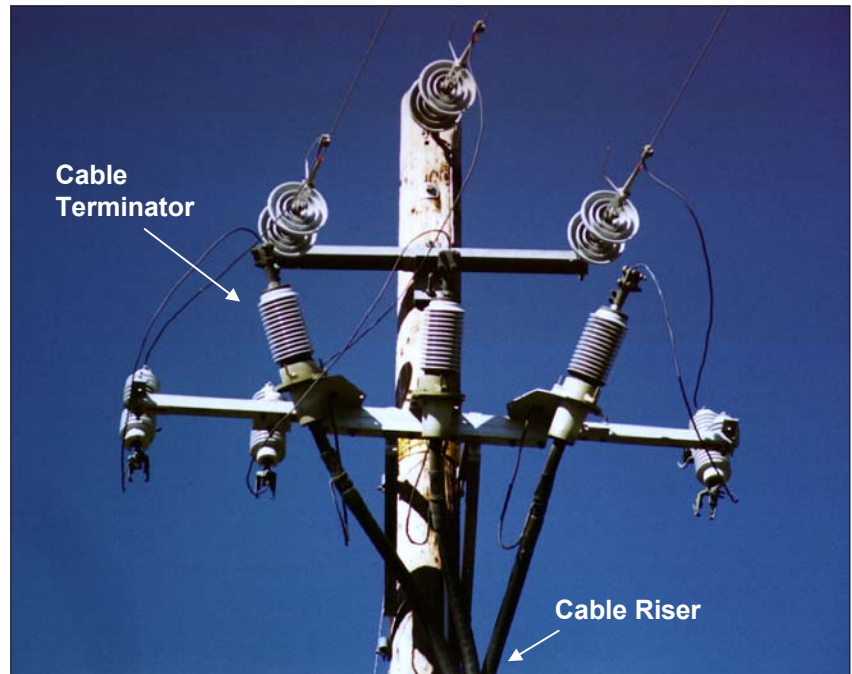

Figure 4-9
Cable Riser with Cable Terminator

Figure 4-10
Cable Riser with Cable Terminator



Distribution Construction

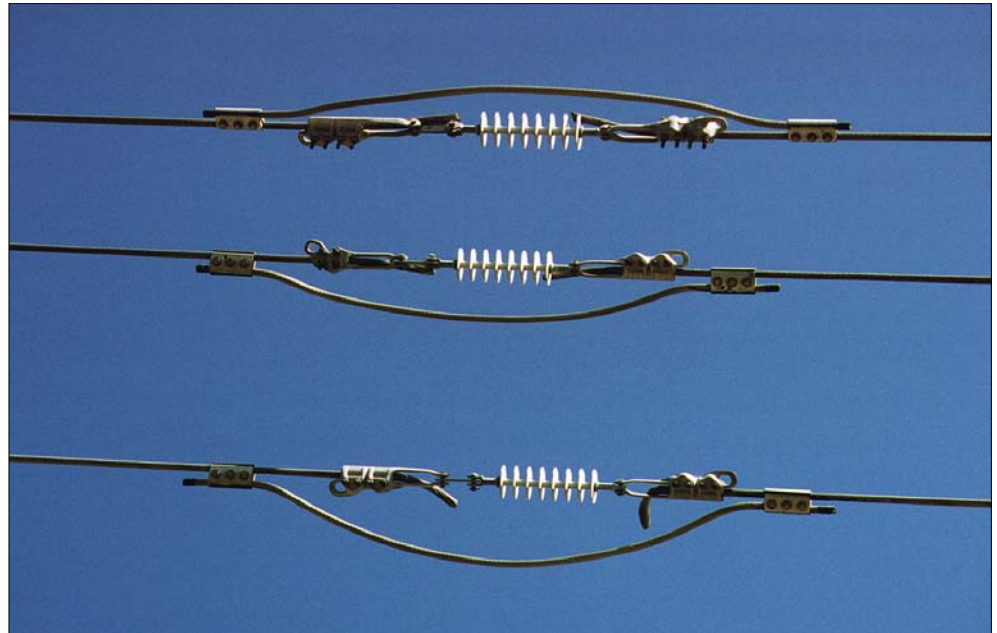
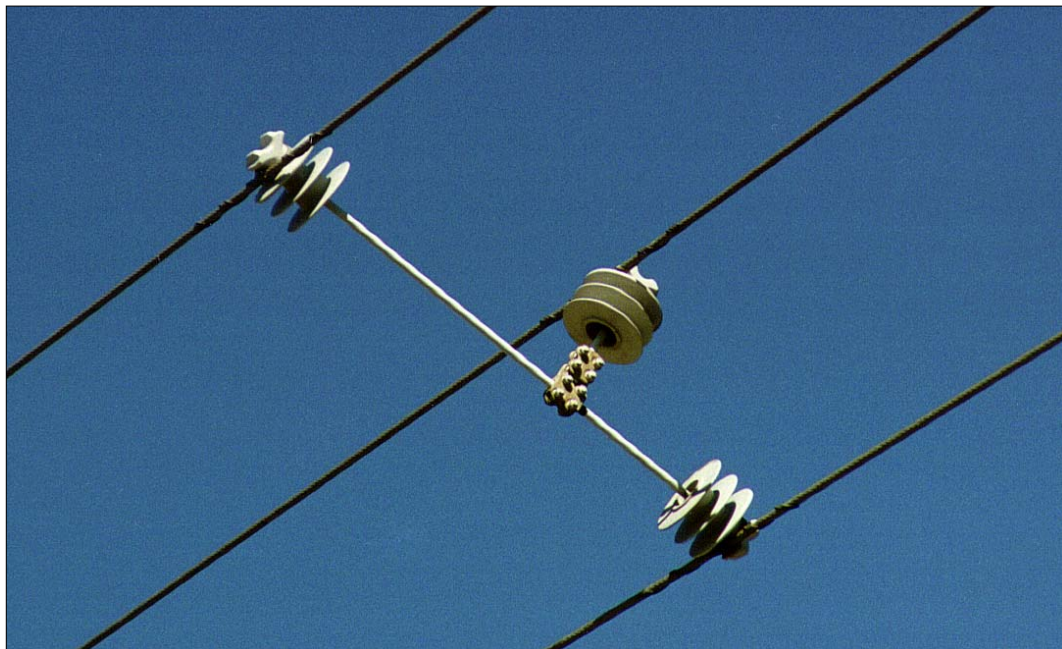

Figure 4-11
Line Opener

Figure 4-12
Long Span Conductor Spreader



Distribution Construction

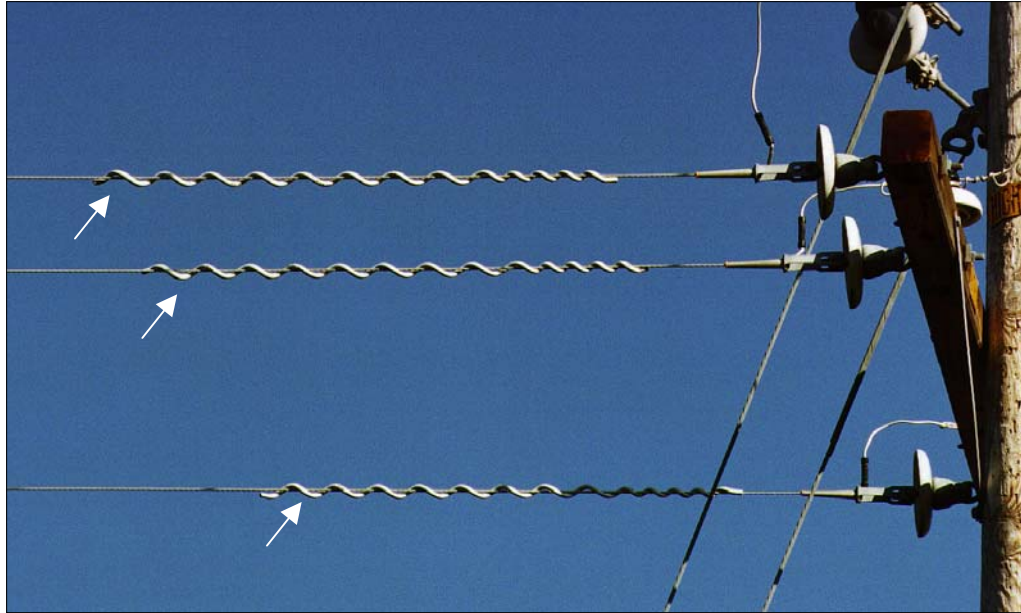
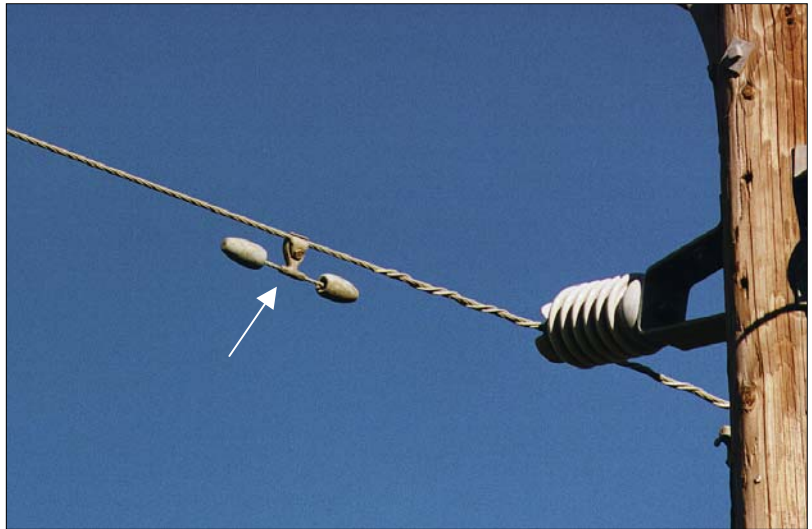

Figure 4-13
Vibration Damper

Figure 4-14
Vibration Damper



Animal Protection

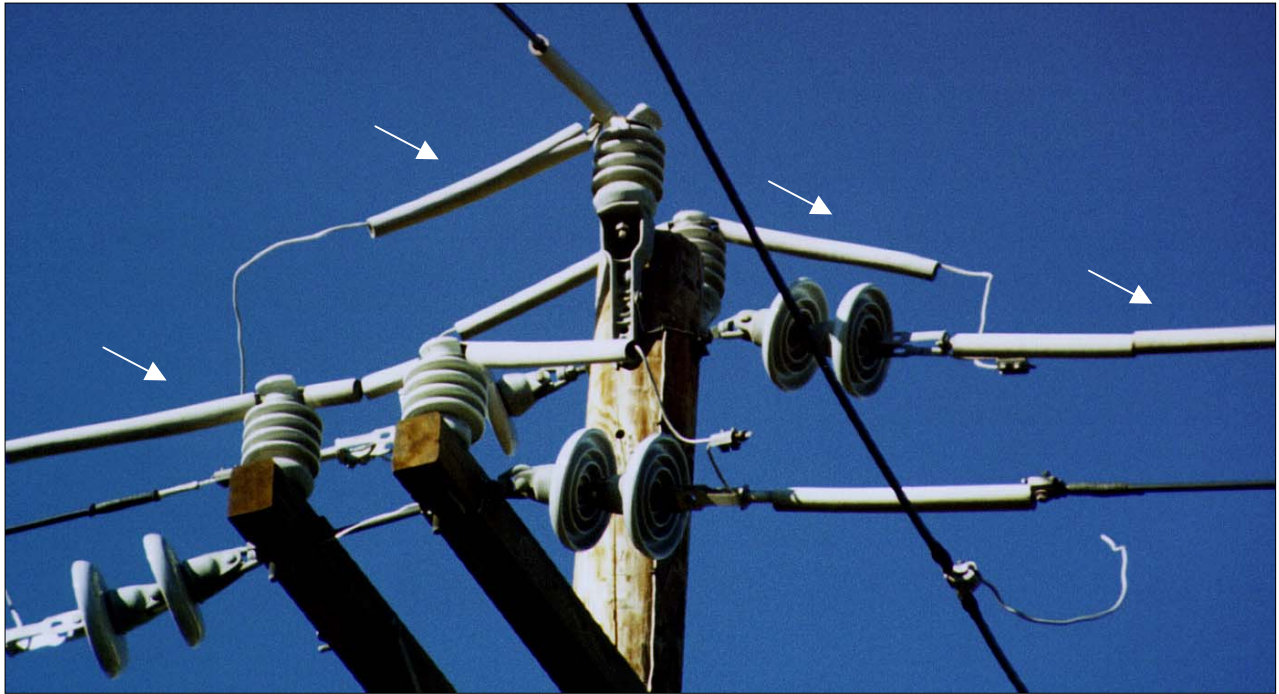
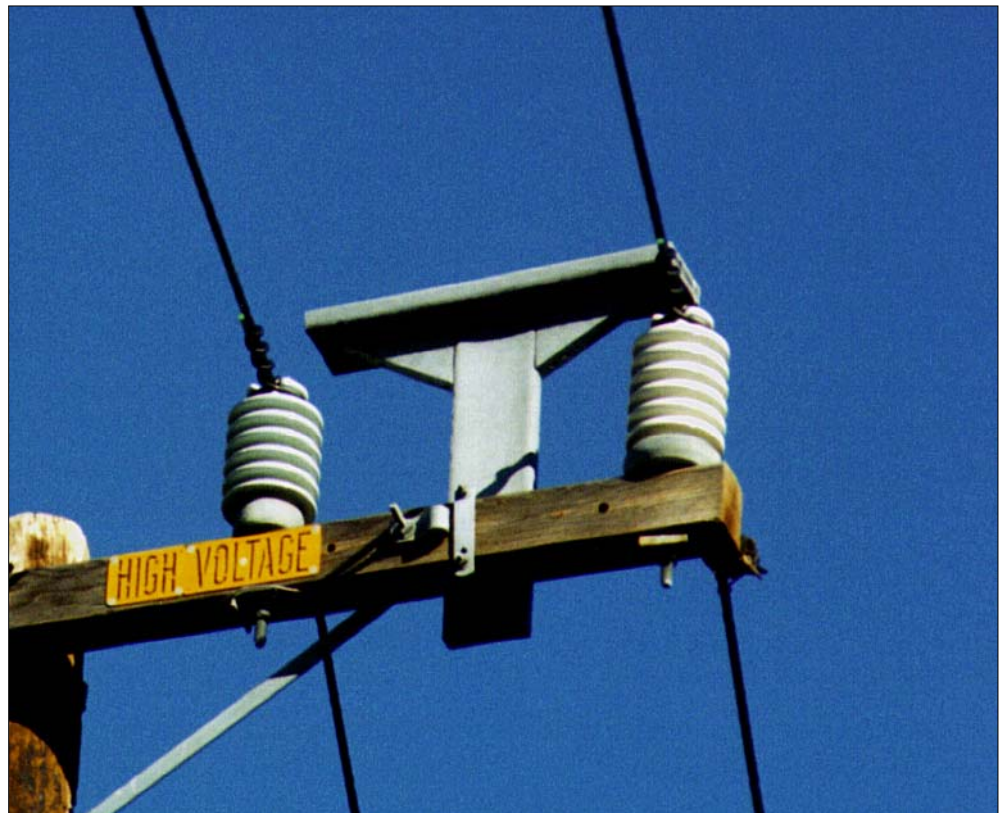

Figure 4-15
Insulated Conductor Covering

Figure 4-16
Raptor Perch



Animal Protection

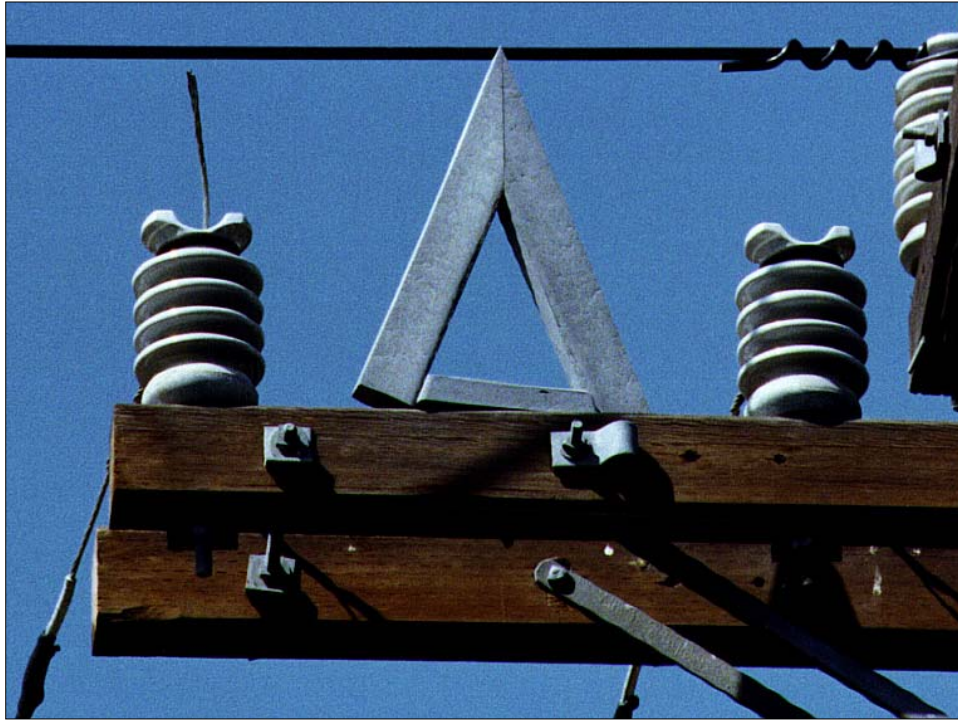
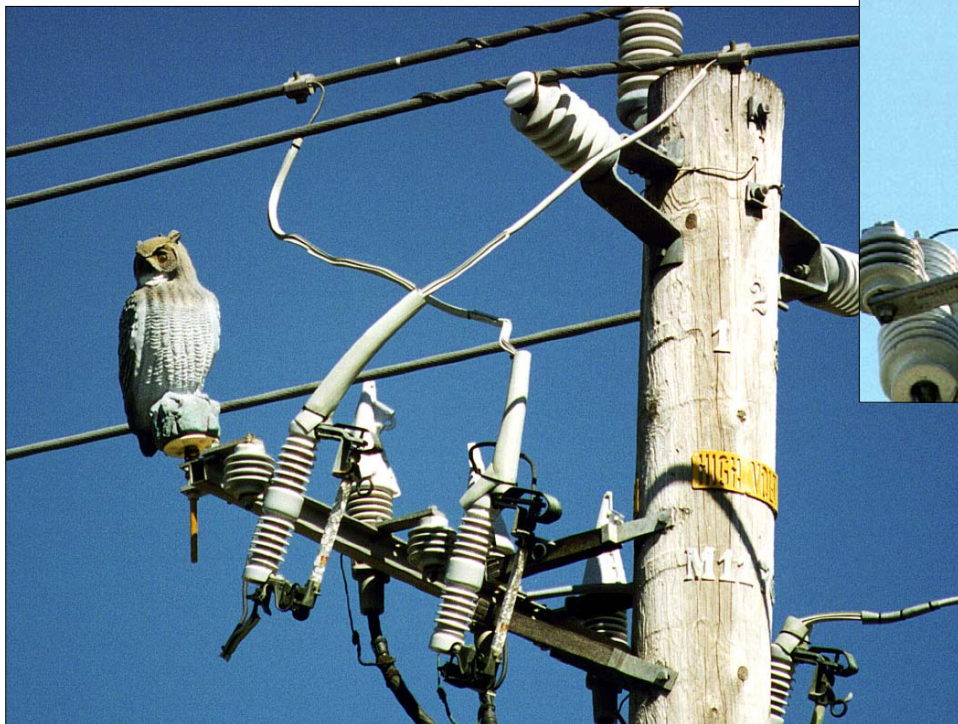

Figure 4-17
Anti-Perch Guard

Figure 4-18
Anti-Perch Owl



Animal Protection

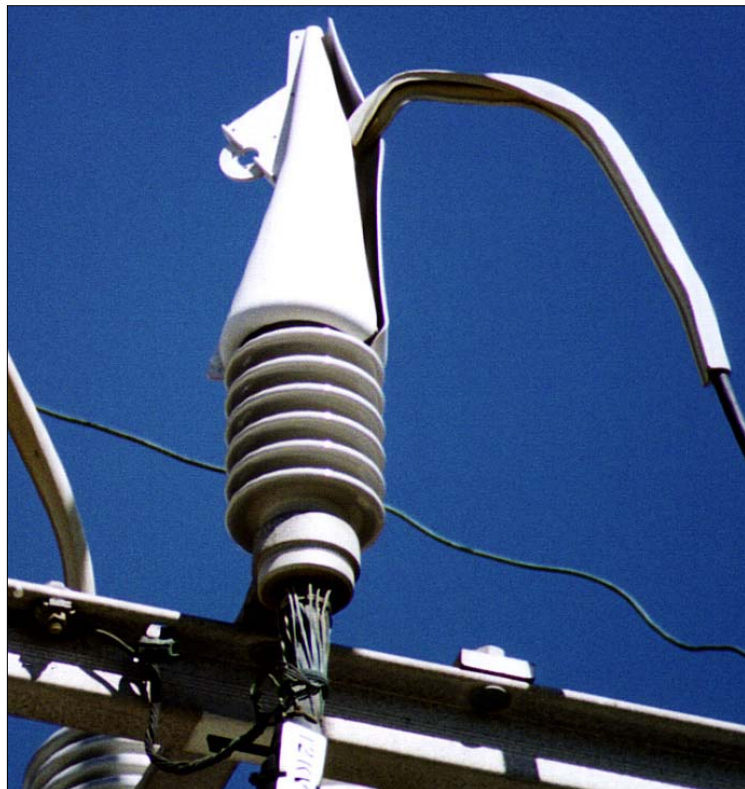
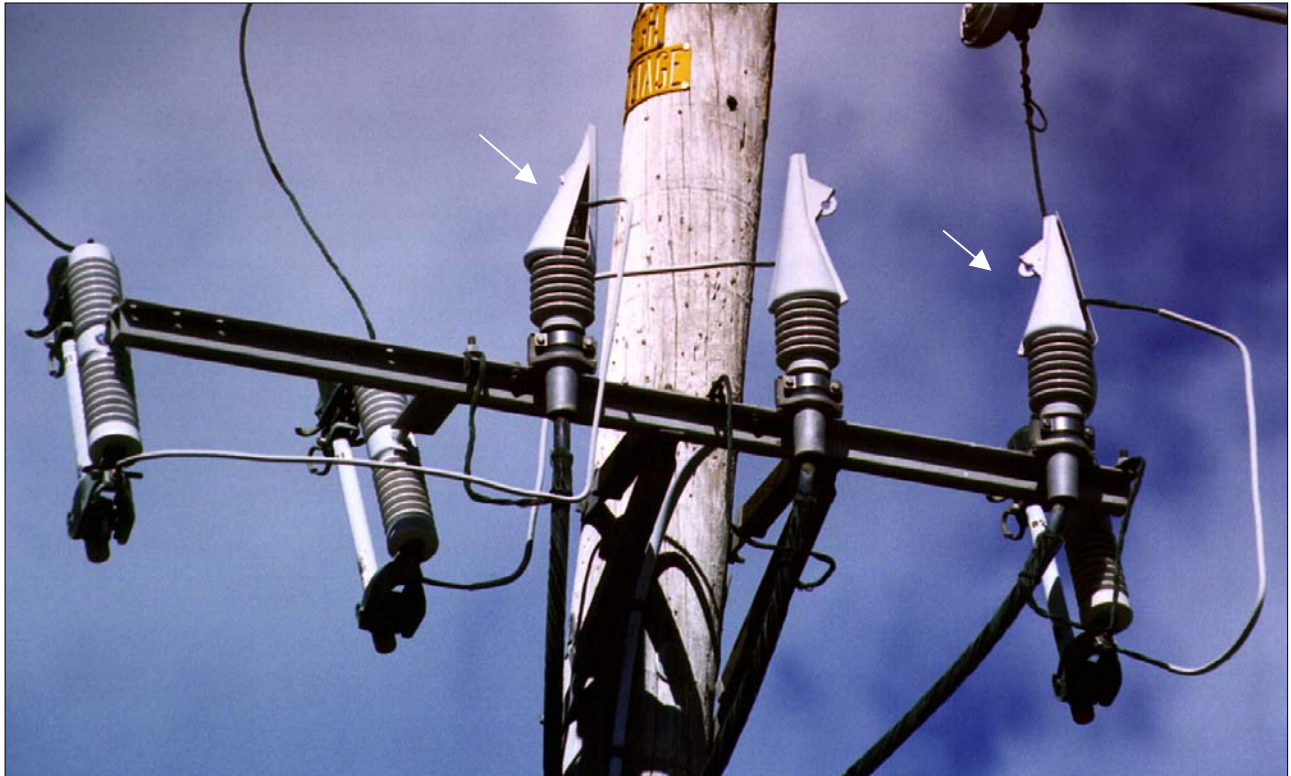

Figure 4-19
Squirrel Guard

Transmission Construction

Figure 4-20
Figure Four (4)

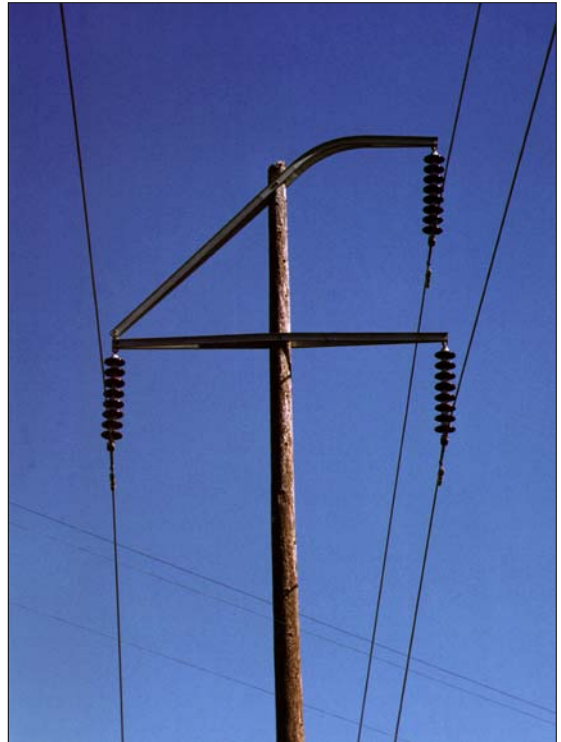
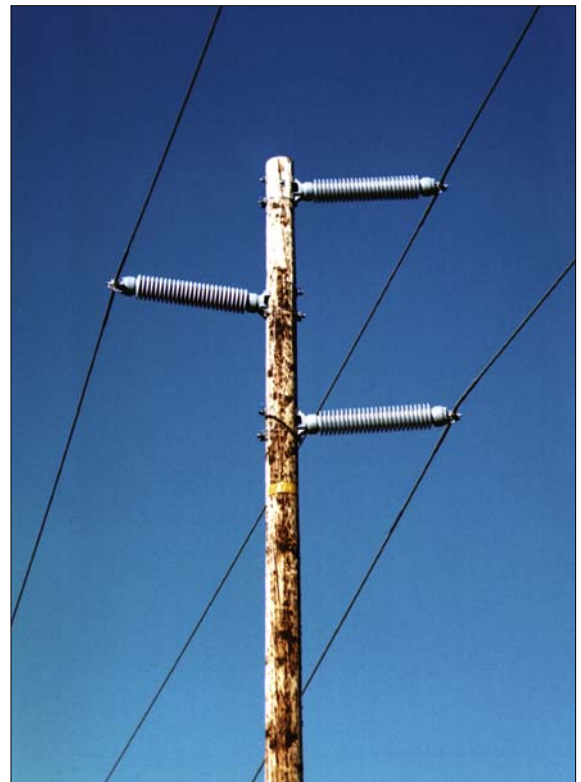

Figure 4-21
Vertical Post



Figure 4-22
Triangular Post



Transmission Construction

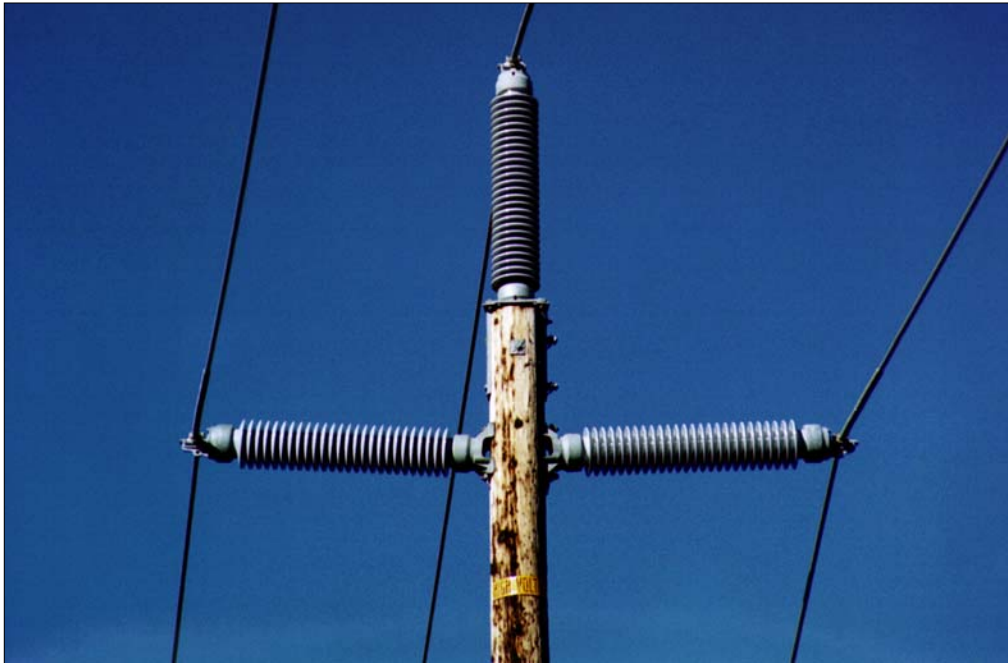

Figure 4-23
Triangular Configuration

Figure 4-24
Gull Wing



Transmission Construction

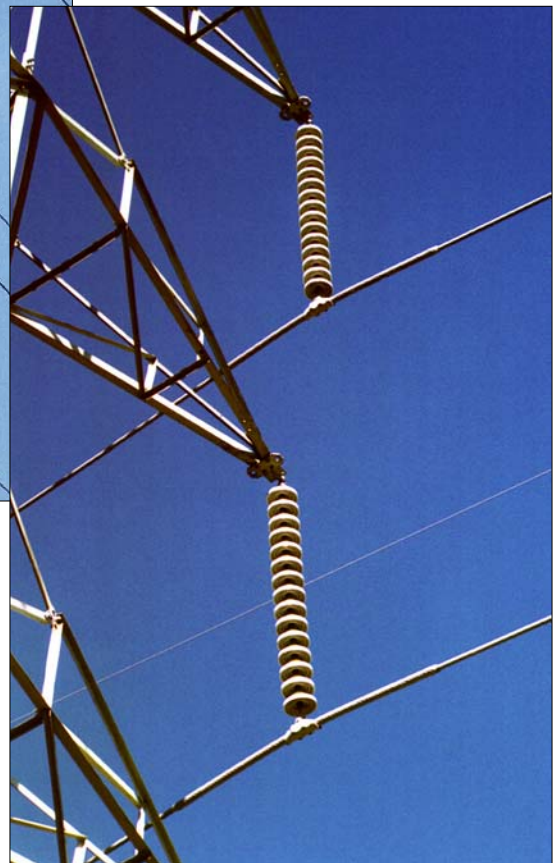
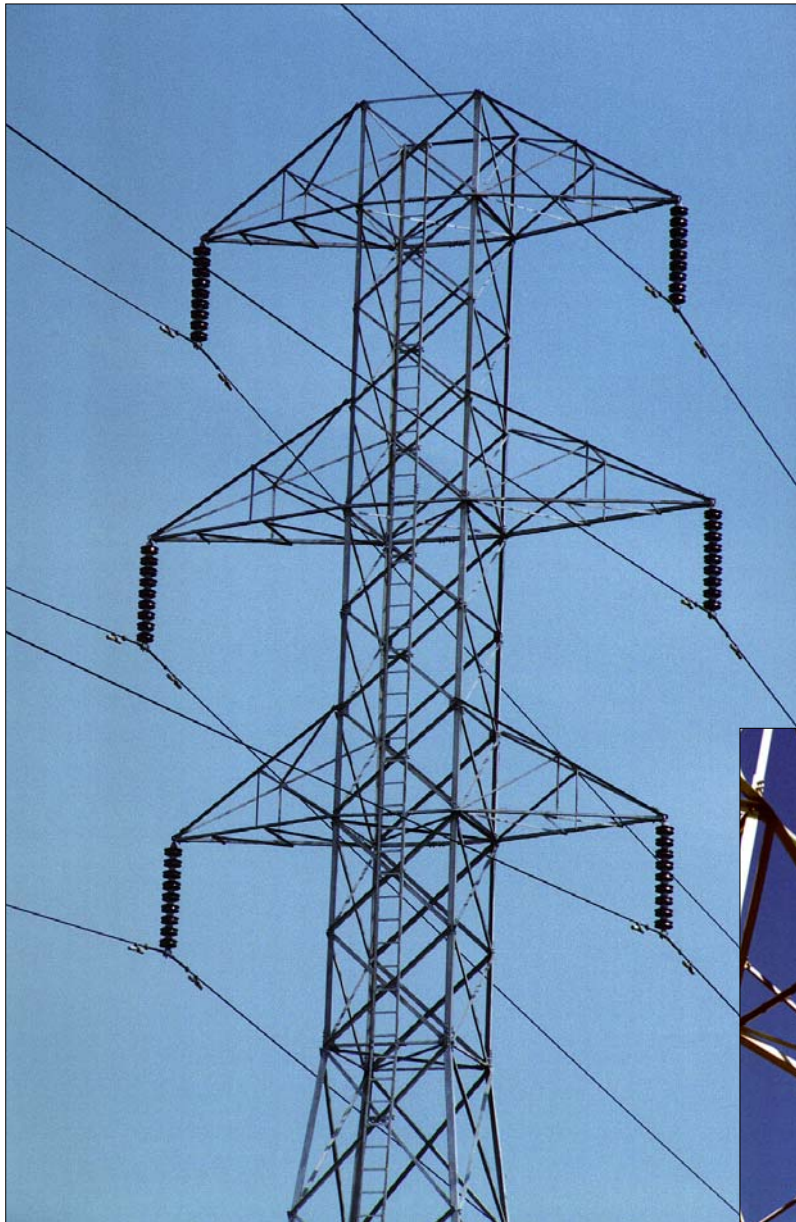

Figure 4-25
Suspension Tower

Transmission Construction

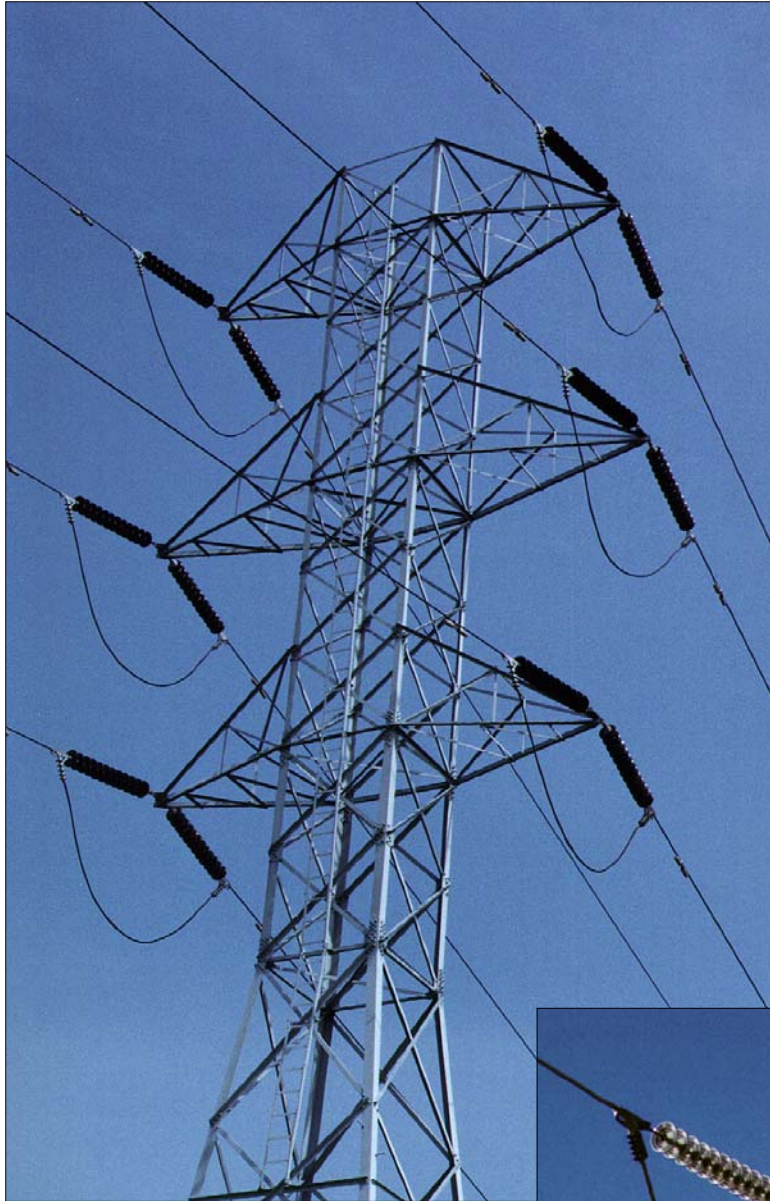

Figure 4-26
Deadend Tower



Transmission Construction



Figure 4-27
**Tangent Transmission Tower with
Static Line**

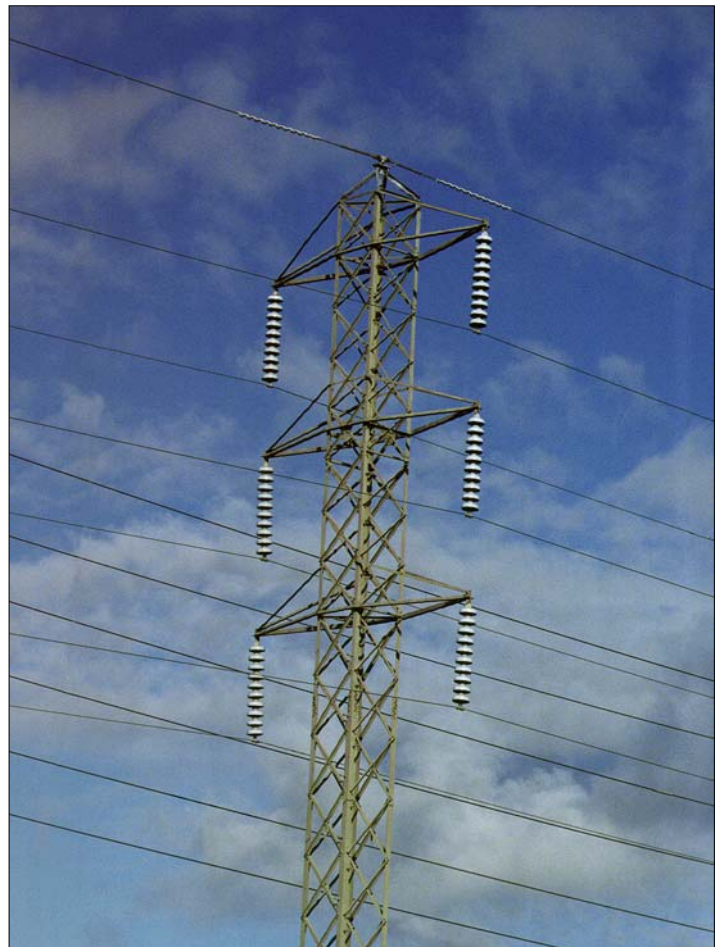

Section 5

Bulletins/Correspondence

Section 6

List of Figures/Glossary of Terms

List of Photographs and Figures

Section 1: Introduction

Figure 1: Major California Utility Companies.....	1-4
Figure 2: California Interagency Fire Safety Inspection Legal Notice (FS 5100-209 and CDF LE-38).....	1-15
Figure 3: California Interagency Fire Safety Inspection Legal Notice (CDF LE-38A).....	1-16
Figure 4: Non-Exempt Pole Identification – Southern California Edison	1-17
Figure 5: Non-Exempt Pole Identification – Pacific Gas & Electric.....	1-17
Figure 6: Definition of Outer Circumference Examples.....	1-35
Figure 7: Time of Year by Location when Powerline Hazard Reduction Standards are Applicable	1-36
Figure 8: Fire Break Clearance Requirements Around Poles and Towers.....	1-37
Figure 9: Conductor Clearance	1-38
Figure 10: Burning Permits; Zones; Times	1-39

Section 2: Non-Exempt Equipment

Figure 2-1: Universal Fuse.....	2-1
Figure 2-2: Universal Fuse – Detail	2-1
Figure 2-3: Arm Mounted Cutout with Universal Fuse.....	2-1
Figure 2-4: Arm Mounted Cutout with Open Link Fuse.....	2-2
Figure 2-5: Bushing Mounted Cutout with Open Link Fuse	2-3
Figure 2-6: Enclosed Cutouts.....	2-4
Figure 2-7: Arm Mounted Enclosed Cutout with Universal Fuses	2-4
Figure 2-8: Arm Mounted Cutout with Solid Blade Disconnect (open)	2-5
Figure 2-9: Arm Mounted Cutout with Solid Blade Disconnect (closed).....	2-5
Figure 2-10: Solid Blade Disconnects.....	2-6
Figure 2-11: Solid Blade Disconnect.....	2-7
Figure 2-12: In-Line Disconnect (closed)	2-8
Figure 2-13: In-Line Disconnects (closed)	2-8
Figure 2-14: In-Line Disconnect (open)	2-9
Figure 2-15: In-Line Disconnects (open).....	2-9
Figure 2-16: Arm Mounted Lightning Arrester (with Cable Riser and Universal Fuses).....	2-10
Figure 2-17: Lightning Arrester (with recloser).....	2-10
Figure 2-18: Lightning Arrester	2-11
Figure 2-19: Lightning Arrester	2-11
Figure 2-20: Non-Porcelain Lighting Arrester	2-12
Figure 2-21: Non-Porcelain Lighting Arrester	2-12
Figure 2-22: Transformer Mounted Lightning Arrester.....	2-13
Figure 2-23: Gapped Lightning Arrester	2-13
Figure 2-24: Lightning Arrester	2-14
Figure 2-25: Lightning Arrester	2-14
Figure 2-26: Hot Tap Clamps.....	2-15
Figure 2-27: Split Bolt Connectors (various sizes).....	2-16
Figure 2-28: Split Bolt Connector	2-16
Figure 2-29: Fargo Connector.....	2-17
Figure 2-30: LM Connector	2-17
Figure 2-31: Grasshopper Air Switch (closed).....	2-18
Figure 2-32: Grasshopper Air Switch (open)	2-18
Figure 2-33: Transmission Air Switch, Pole Mounted 60kV (closed).....	2-19
Figure 2-34: Transmission Air Switches	2-20

Section 3: Exempt Equipment

Figure 3-1: Arm Mounted Cutout with Non-Expulsion Fuse	3-1
--	-----

Figure 3-2: Arm Mounted Cutout with Non-Expulsion Fuse	3-1
Figure 3-3: Arm Mounted Cutout with Non-Expulsion Fuses.....	3-1
Figure 3-4: Bushing Mounted Cutout with Non-Expulsion Fuse	3-2
Figure 3-5: Bushing Mounted Cutout with Non-Expulsion Fuse	3-2
Figure 3-6: Arm Mounted Cutout with Liquid Filled Fuse.....	3-3
Figure 3-7: Bushing Mounted Cutout with Liquid Filled Fuse	3-4
Figure 3-8: Arm Mounted Cutout with SMU-20 Fuses	3-5
Figure 3-9: SMU-20 Fuse - Detail	3-5
Figure 3-10: Arm Mounted Cutout with SMU-20 Fuses	3-5
Figure 3-11: Arm Mounted Cutout with S&C Fault Tamer Fuse	3-6
Figure 3-12: 600 Amp KPF Air Switch, Triangular Construction (closed).....	3-7
Figure 3-13: 600 Amp KPF Air Switch, Triangular Construction (open)	3-7
Figure 3-14: 600 Amp KPF Air Switch, Crossarm Construction (closed) with arcing horns & snuffers.....	3-8
Figure 3-15: 600 Amp KPF Air Switch, Crossarm Construction (closed) without arcing horns or snuffers... 3-8	
Figure 3-16: 600 Amp Underarm Sidebreak Switch (open).....	3-9
Figure 3-17: 600 Amp Underarm Sidebreak Switch (closed)	3-9
Figure 3-18: S&C 600 Amp Underarm Sidebreak Switch (open)	3-10
Figure 3-19: S&C 600 Amp Underarm Sidebreak Switch (closed)	3-10
Figure 3-20: S&C Omni-Ruptor Switch, Triangular Construction (open).....	3-11
Figure 3-21: S&C Omni-Ruptor Switch, Tangent Construction (closed).....	3-11
Figure 3-22: S&C Scada-Mate Switch	3-12
Figure 3-23: Recloser with In-Line Disconnects (open).....	3-13
Figure 3-24: Recloser with Solid Blade Disconnects (closed)	3-13
Figure 3-25: Sectionalizer with Solid Blade Disconnects.....	3-14
Figure 3-26: Sectionalizer	3-14
Figure 3-27: Voltage Regulator with Solid Blade Disconnects	3-15
Figure 3-28: Voltage Regulator	3-15
Figure 3-29: Capacitor Bank	3-16
Figure 3-30: Self-Protected Transformer	3-17
Figure 3-31: Conventional Transformer with Exempt Fuses	3-17
Figure 3-32: Parallel Groove Connectors	3-18
Figure 3-33: Parallel Groove Connectors - Copper	3-18
Figure 3-34: Transmission Deadend with Parallel Groove Connectors.....	3-19
Figure 3-35: Hot Tap Clamps.....	3-20
Figure 3-36: Piercing Hot Tap Clamp on Tree Wire.....	3-21
Figure 3-37: Piercing Hot Tap Clamp - Detail	3-21
Figure 3-38: Idle Split Bolt Connectors	3-22
Figure 3-39: Bolted Wedge Connector	3-23
Figure 3-40: Fired Wedge Connectors.....	3-23
Figure 3-41: Compression Connectors	3-24
Figure 3-42: Transmission Vertical Deadend with Bolted Flat Plate Connector.....	3-25
Figure 3-43: Bolted Flat Plate Connector.....	3-25
Figure 3-44: Automatic Deadends	3-26
Figure 3-45: Automatic Deadends with Suspension Insulators	3-26
Figure 3-46: Line Splices	3-27
Figure 3-47: Automatic Splices	3-27

Section 4: Construction

Figure 4-1: Vertical Angle.....	4-1
Figure 4-2: Triangular.....	4-1
Figure 4-3: Alley Arm	4-2
Figure 4-4: Crossarm (Tangent).....	4-2
Figure 4-5: Tangent Crossarm with Deadend Tap (T-Tap)	4-3
Figure 4-6: Crossarm Deadend Corner (Line and Buck).....	4-3
Figure 4-7: Crossarm Double Deadend	4-4

Figure 4-8: Triangular Double Deadend 4-4
Figure 4-9: Cable Riser with Cable Terminator..... 4-5
Figure 4-10: Cable Riser with Cable Terminator..... 4-5
Figure 4-11: Line Opener 4-6
Figure 4-12: Long Span Conductor Spreader 4-6
Figure 4-13: Vibration Damper 4-7
Figure 4-14: Vibration Damper..... 4-7
Figure 4-15: Insulated Conductor Covering 4-8
Figure 4-16: Raptor Perch..... 4-8
Figure 4-17: Anti-Perch Guard 4-9
Figure 4-18: Anti-Perch Owl..... 4-9
Figure 4-19: Squirrel Guard 4-10
Figure 4-20: Figure Four (4)..... 4-11
Figure 4-21: Vertical Post..... 4-11
Figure 4-22: Triangular Post 4-11
Figure 4-23: Triangular..... 4-12
Figure 4-24: Gull Wing 4-12
Figure 4-25: Suspension Tower 4-13
Figure 4-26: Deadend Tower 4-14
Figure 4-27: Tangent Transmission Tower with Static Line..... 4-15

Glossary of Terms

Ampere - Unit of electric current (One volt applied across one ohm of resistance will produce one ampere of current).

Armor Rods - Metal rods wrapped around conductors and attached to insulators that prevent wear and fatigue of the conductors.

Automatic Recloser - Pole mounted, oil-filled switch that will open a circuit automatically if faulted and then may close automatically to try to complete the circuit again.

Capacitor Bank - Pole mounted device for neutralizing inductive load to correct the power factor.

Circuit-Transmission - High voltage circuit (50-500 kV) between generating source and switchyard (substation).

Circuit-Distribution - Circuit between main switchyard and point of use.

Circuit-Primary Distribution - High voltage circuit (2.4-35 kV) between switchyard and service transformer.

Circuit-Secondary Distribution - Low voltage (750 volt, usually 120, 208, 240, or 480) circuit between transformer and point of use.

Clearance - Space cleared of vegetation as required by law, regulation, easement, etc., for the purpose of preventing power line-caused fires.

Clearance-Conductor - Distance from overhead open conductors which must be kept free of vegetation; distance varies depending on voltage carried by conductors.

Clearance-Pole - Radial space around base of pole or tower, measured horizontally, which must be kept free of flammable vegetation if certain hardware is in use overhead.

Conductor - Path through which an electric current flows, metal wire or cable.

Conductor-Unprotected - Uninsulated conductor.

Connector - Mechanical device used to join two conductors.

Connector-Automatic - Sleeve type connector requiring tension on the conductors to maintain connection; unsafe in non-tension situation.

Connector-Bolted - A device used for fastening two or more conductors together.

Connector-Compression - A device for joining two conductors together when a metal sleeve is used and mechanically or hydraulically pressed to secure tension (no bolts). For purpose of the PRC, a compression connector is considered to make the conductor continuous.

Connector-Fired Wedge - A connector joining the conductors by compressing them between two wedge-shaped objects. Exempt from clearance requirements.

Connector-Parallel Groove - A connector so designed that tightening of one or more bolts will compress sides of connector against conductors placed in performed grooves. Exempt from clearance requirements.

Connector-Plate - A connector joining the conductors by bolting two flat plates together. If two or more bolts are used, this type of connector is exempt from clearance requirements.

Corner Pole - Any pole (tower) where the conductors make an angle of 60 degrees or more from their previous alignment.

Current - Flow of electricity measured in amperes.

Current Limiting Fuse - A device used in conjunction with fuses near where heavy fault currents will occur.

Dead End - Point where the conductors end; other conductors in many cases will continue on and be connected to the preceding conductors by jumper wires and various forms of connectors.

Disconnect - See Pole Disconnect.

De-Energized - Dead, disconnected from electrical energy.

Energized - Live, connected to a source of electrical energy.

Exempt - Does not require clearance of flammable vegetation.

Fault - A break in the circuit, an unwanted path for electric current.

Fire Hazard - Dangerous accumulation of flammable fuels in wildland areas usually referring to vegetation.

Fuse-Cutout-A device designed to open the circuit in case of short or overload.

Fuse-Open Link (Trip-O-Link) - A non-exempt, low current (050 Amp) fuse.

Fuse-Universal - A non-exempt, medium capacity (50-100 Amp) fuse.

Fuse-Liquid Filled - An exempt type of fuse in which the fusible link is entirely enclosed in liquid.

Ground - To connect a line or piece of equipment to the earth.

Hot Clamp - A type of bolted connector which can be installed without de-energizing the circuit.

Insulation - Protective covering, around a conductor or other piece of equipment, which is a non-conductor of electricity (not just a weather resistant cover).

Insulator - Porcelain or non-ceramic unit used to support and separate conductors from each other and from ground (Air can also be an insulator).

Kilovolt - 1,000 volts (kV).

Lightning Arrester - A device designed to channel lightning or over voltage it to ground in order to protect the circuit or equipment from excessive fault current.

Non-Exempt - Requires clearance of flammable vegetation.

Ohm - Unit of resistance to flow of electric current (One ohm of resistance requires one volt of energy to push one ampere of current across it).

Phase - One wire or conductor of a circuit.

Pole Disconnect - Type of switch mounted on a pole (Blades are opened and closed manually one at a time). Same as disconnect.

Pole Switch - Switch mounted on a pole (All blades open and close together with one handle).

Regulator-Voltage - Pole-mounted device for correcting voltage.

Risk-Fire - Potential for ignition of fuels or an ignition agent.

Self-Supporting Aerial Cable - Several insulated conductors wrapped around a non-energized steel support cable, used primarily for service drops and secondary conductor.

Service Drop - Portion of the power line from the secondary distribution line to the point of use (between pole and house).

Split-bolt Connectors-Kearney - A type of bolted connector.

Switchyard-Substation - An area in which are located switches, transformers, circuit breakers, etc., and where voltages are changed to or from transmission levels.

Transformer - A device, mounted on a pole, pad, vault, or in a switchyard, encased in metal and used to reduce or increase voltage.

Transformer Conventional - A transformer with no internal fuses. Fuses are required between the transformer and the line.

Transformer-CP Self-Protected - Self-protected has internal fuses on the primary side and circuit breakers on the secondary side.

Transformer-CSP - Current surge protected same as CP but with externally mounted lightning arresters.

Tree Wire - Fully covered conductor .

Vibration Dampers - Hardware attached to conductors (usually near insulators) to inhibit fatigue from wind-caused vibration).

Volt - Unit of electric energy force (One volt is required to push one ampere of current across one ohm of resistance). Roughly analogous to psi of pressure in a fire hose.

