



A  Sempra EnergySM company

GUIDE FOR ENCROACHMENT SDG&E ELECTRIC TRANSMISSION RIGHTS OF WAY

Revised June 2003



GUIDE FOR ENCROACHMENT ON TRANSMISSION RIGHTS OF WAY

<u>ITEM</u>	<u>TOPIC</u>	<u>PAGE</u>
1.	GENERAL	3
2.	PERMISSION TO GRADE.....	3
3.	GRADING AND CLEARANCES.....	4
4.	ROADS AND DRAINAGE	5
5.	FENCES, WALLS, GATES AND OTHER STRUCTURES	9
6.	VEGETATION	9
7.	ACCESS AND ENCROACHMENT DOCUMENTS	12
8.	RELOCATION OF TRANSMISSION FACILITIES	13
9.	ENCROACHMENT ON 500KV ROW	14
10.	ELECTRIC TRANSMISSION UNDERGROUND	15

APPENDIX

1.	MAINTENANCE AND WORKING PADS.....	11860-01 thru 11860-06
2.	GROUNDING REQUIREMENTS.....	11861-01
3.	GROUNDING-METALLIC STRUCTURES.....	11861-02
4.	GROUNDING-GATES AND FENCES	11861-03
5.	GROUNDING-ELECTRIC FENCES	11861-04
6.	ACCESS ROAD DETAILS-CULVERTS.....	11862-01
7.	ACCESS ROAD DETAILS-DOWN DRAINS	11862-02
8.	ACCESS ROAD DETAILS-ENERGY DISSIPATOR	11862-03
9.	ACCESS ROAD DETAILS-WATER BARS	11862-04
10.	ACCESS ROAD DETAILS-ROAD CROSS SECTIONS	11862-05 thru 11862-10

GUIDE FOR ENCROACHMENT ON TRANSMISSION RIGHTS OF WAY

GENERAL

This guide is designed to assist developers and engineers through the process of developing property within or directly adjacent to San Diego Gas and Electric's (SDG&E) existing electric transmission rights of way containing 69 kV, 138 kV and 230 kV facilities. A special section (section 9) is provided regarding transmission right of way containing 500 kV electric transmission facilities.

This guide is being furnished as an aid in streamlining SDG&E's plan review process and to minimize potential negative impacts to SDG&E's transmission facilities and rights of way. Some aspects of SDG&E's rights of way are too elaborate to be included in these guidelines. The guidelines may be supplemented with additional requirements for a specific area, as SDG&E deems necessary.

Developers and engineers should bear in mind that compliance with the requirements of the guide does not mean an automatic acceptance of your project by SDG&E. SDG&E's approval to allow grading or encroachments within SDG&E's transmission easements or fee properties will be provided through a "Permission to Grade Letter" along with either a "Joint Use Agreement", "Consent Agreement" or a "Right of Way Use Agreement" depending on the type of encroachments.

PERMISSION TO GRADE

Developers must submit grading plans and site development plans (and geotechnical reports if applicable), signed and dated, for SDG&E's review. All SDG&E facilities, existing structures, structure numbers, existing anchors, right of way boundaries, document recording information and existing and proposed access roads must be shown on the submitted plans. Upon receipt of plans by SDG&E's Land Management Department lead times of six (6) to eight (8) weeks are normal.

It is the developer's sole responsibility to comply with all rules, regulations, and orders of State, County, and local agencies having jurisdiction. For example, the California Department of Education has developed recommendations for minimum distances between schools and transmission lines as part of its school site selection and approval guide. For further information about the guide, contact: The School Facilities Planning Division Coordinator, Department of Education, P.O. Box 944272, Sacramento, California 94244-2770, Telephone: (916) 322-1461.

Also, location of developer's improvements above or below ground and/or adjacent to SDG&E rights of way requires the developer to be in compliance with CAL-OSHA and/or the rules for Overhead Electric Line Construction, General Order No. 95

and Underground Electric Line Construction General Order No. 128 CPUC, during their construction and maintenance of those facilities. CAL-OSHA is located at 7807 Convoy Court, San Diego, CA 92111, 1-800-963-9424.

Grading without SDG&E's written permission is not permitted within SDG&E transmission rights of way. Any necessary steps, including legal action, will be taken to stop activity and restore the rights of way to its original condition at the developer's expense.

GRADING AND CLEARANCES

Conceptual drawings, tentative maps, layouts, and preliminary and final grading plans should be prepared with the following in mind:

1. **Clearances:** Minimum clearance from ground to any transmission voltage conductor of 69kV, 138kV and 230kV shall not be less than thirty-five (35) feet when the conductor is at maximum designed sag as shown on the SDG&E design profiles. Clearance shall not be calculated using "everyday" sag. The sag differential can vary from four (4) feet to thirty (30) feet between "everyday" and "maximum design" sags. Clearance requirements for 500KV transmission lines are provided in Section 9, page 14.
2. **Profile:** Profile drawings submitted to SDG&E shall be drawn to a scale of: 100 feet horizontal and twenty (20) feet vertical, or 200 feet horizontal and forty (40) feet vertical and the survey datum shall be specified.
3. **Compaction:** Any and all fill shall be engineered and placed to a minimum compaction of ninety (90) percent maximum dry density as determined by ASTM (American Society for Testing and Materials) D1557, unless specified otherwise. SDG&E may require compaction tests to be performed at the developer's expense. Where there is the possibility of future structures being placed in the rights of way, SDG&E may require compaction to a minimum of ninety-five (95) percent maximum dry density. Compaction tests are performed at the developer's expense.
5. **Maintenance/Construction Pads:** All existing structures and all future structure positions shall be provided with level maintenance/construction pads as well as working areas as indicated by drawings 11860-01 through 11860-06. Stringing and construction areas shall remain undisturbed.
6. **Cut/Fill Clearances:** No cut or fill will be allowed within the horizontal distances indicated below, measured from the face of each type of structure or anchor.

<u>Structure Type</u>	<u>Distance</u>
Single wood pole or anchor	10'
Multi-wood pole	15'
Steel lattice tower	20'
Steel pole	30'

7. **Retaining System:** Any retaining walls and devices within three (3) times the distance specified in Items 5 and 6 will be considered as structurally integral to the transmission structure. All such devices will require SDG&E's Civil/Structural Engineering Section's approval prior to SDG&E approval of developer's plans.
8. **Graded Slopes:** Graded slopes of up to 2:1 will be selectively permitted for distances not to exceed 200 linear feet. Longitudinal grading encroachments, cuts or fills may not exceed ten (10) feet into the right of way.

ROADS AND DRAINAGE

SDG&E's access roads must be designed to accommodate all types of vehicles used for roadway construction, placement of poles and/or towers, wire stringing and maintenance during all phases of construction and maintenance. Developers should comply with the following minimum guidelines and the current edition of the Standard Specifications for Public Works Construction ("Green Book") and ensure that adequate access is provided at all times.

1. **Grading Plans/Improvement Plans:** Existing and proposed access roads will be shown on the grading/improvement plans.
2. **Access:** Access and through access, to and along the rights of way, is required on a 24-hour basis to all SDG&E facilities, structures, and anchors for patrol, maintenance, and emergency vehicles.
3. **Use:** Access roads shall not be used or dedicated for public or shared use including but not limited to hiking or horse trails.
4. **Widths:** Minimum width on access roads shall be fourteen (14) feet. Curves require additional road width as shown on the table below.
5. **Horizontal Curves:** All road curves shall have a minimum radius of seventy-five (75) feet measured at the centerline of the usable road

surface. Inside edge of the curves shall be used as the control for establishing road grades.

Radius Of Curvature	Additional Road Width
75' – 100'	6'
101' – 150'	5'
151' – 200'	4'
201' - 400'	3'
Over 400'	2'

6. **Speed Limit:** Unpaved roads may be designed for 15 mph maximum.

7. **Wearing Surface:**

<u>Road Grade</u>	<u>Surface</u>
0 – 10 percent	Native Soil
11 – 14 percent	Class 2 Base (6" thick)
15 – 17 percent	Asphalt (4" AC over 6" Class 2 Base)
18 – 20 percent	Concrete (5 ½" over 6" Class 2 Base)

8. **Grades:** Road grades over fifteen percent (15%) are discouraged and require special review. Grades of 15% to 20% shall be limited to a length of 250 ft. maximum. Consideration must be given to drainage issues.
9. **Cross Slopes:** The road shall be sloped (2% typical cross slope) to prevent ponding or damage from undirected water flow and in accordance with drawing 11862 (05 through 10). When the road is designed to slope away from the cut bank, the water shall be allowed to drain as sheet flow onto the downhill slope (not allowed when slope is fill) unobstructed by drainage swales or berms. When the road is sloped towards the cut bank, a drainage swale along the inside edge of the road shall be provided. Water bars shall also be provided across the road to direct water into the drainage swale. (See drawing 11862-04).
10. **Vertical Curves:** Typically, vertical curves are not necessary in the design and construction of access roads. However, where grade breaks over 6% occur, the resulting profile should be evaluated against high centering and tail dragging.
11. **Stopping Sight Distance:** Care should be taken to provide stopping sight distance at all intersections with other roadways, public or private.

Typical design per Section 200 of Caltrans' Design Standards should be adequate.

12. **Dead-Ends/Turnarounds:** All dead-end or stub roads over 500 feet in length shall be provided with a Y-type, T-type, or circular type turn-around. See City of San Diego Fire Department Design Standard, FDDS-101 page 5 of 6.
13. **Drainage Design :** Drainage systems shall be sized for a 10-year storm based on the San Diego County Flood Control Design Manual. Ponding will not be allowed. Where access roads meet a publicly maintained road, drainage shall be designed to meet the minimum requirement of the municipality or agency having jurisdiction over the publicly maintained road (usually a 100-year storm) and meet current SWPP requirements.
14. **Dip Section:** Dip sections should be constructed at natural grade so as not to impede upstream runoff from crossing the road.
15. **Swales:** Brow ditches, swales, etc. should be avoided within the rights of way except transverse to the rights of way and then they shall provide heavy construction equipment access across same. Drainage swales shall be emptied by means of a culvert to the down slope side of the road which then empties onto an energy dissipater or into a natural drainage way.
16. **Culverts:** Corrugated Metal Pipes (CMP) should be used with a minimum of 2 feet of cover. CMP's shall be specified to have a service life of 25 years, based on soil characteristics. Coupling bands and cut-off walls are required. Damaged coating shall be repaired per manufacturers recommendation. For CMP use in Orange County, all metal pipes shall be coated with asphalt to meet Orange County's requirements for corrosion resistance. Minimum design shall meet requirements shown on drawing 11862-01. Developer shall design the size of the CMP culvert to meet the 10-year storm requirement or 12" diameter whichever is greater.
17. **Energy Dissipaters:** All energy dissipaters, standpipes, desiltation basins, etc. shall be designed to be external to SDG&E's rights of way. At a minimum, these shall be designed to the requirements of San Diego Area Regional Standard Drawing D-40 (also see drawing 11862-03).
18. **Flume/dip apron:** Where subject to erosion, roadway banks and natural soil shall be protected by galvanized steel intakes (dip aprons) and down slope drains (troughs) (See drawing 11862-02). Energy dissipaters shall be installed at drain outlets outside of the rights of way.

19. **Water Bars:** Minimum design shall meet the requirements shown on drawing 11862-04. Water bars shall be open at the lower end to allow drainage and be placed at an approximate angle of 30 to 45 degrees to the transverse section of the road spaced as follows:

<u>Average Road Grade</u>	<u>Maximum Spacing</u>
0 – 5 percent	Not required
5 percent	125 feet
10 percent	80 feet
15 percent	60 feet
20 percent	50 feet

20. **Loading Requirements:** All private roadways within the rights of way or roads used as access for SDG&E will be sized for heavy construction vehicular traffic (passable with a 100 ton crane and H-20 loading).
21. **Driveway Entrances:** If commercial aprons are not installed, then curbs shall be designed for H-20 loading and painted red.
22. **Longitudinal Encroachments:** Longitudinal (parallel) encroachments of roads, sewer, water, gas, culverts, drainage culverts, etc., will not be approved.
23. **Utility and Street Crossings:** All utility and street crossings shall be kept to a minimum and should be designed to cross the rights of way or roadways at as close to ninety (90) degrees as possible.
24. **Maintenance Pads:** See drawings 11860 (01 through 06).
25. **Blasting:** Blasting is not permitted on or near the vicinity of SDG&E's rights of way unless written approval is obtained from SDG&E's Land Management Department.
26. **Erosion Control:** All roads and slopes shall have erosion control during and after construction. Best Management Practices (BMPs) shall be applied. Erosion control shall not block access roads at any time. Developer shall assume all responsibilities for obtaining any and all storm water pollution prevention plan (SWPP) permits and maintaining any and all required BMPs, inspections, repairs and logs, required per the permit and the permitting authority.

FENCES, WALLS, GATES AND OTHER STRUCTURES

Temporary structures, including fences, walls and gates, may be allowed within the rights of way only with written approval (*Consent Agreement or R/W Use Agreement*) from a Land Management Representative.

1. **Fences:** Fences and/or walls may be allowed if properly grounded and if access to and along the rights of way is not obstructed and if access to individual structures is not obstructed. (See 11861-01 through 04).
2. **Gates:** Gates will be required where an SDG&E access road is obstructed. Gates shall meet the following criteria:
 - a. All gate openings must be a minimum of fifteen (15) feet in width.
 - b. Gates must be at least 300 feet apart.
 - c. All gates must have provisions for either an SDG&E standard lock or an electric gate over-ride key.
3. **Lighting Standards:** Lighting standards, up to a maximum of fifteen (15) feet in height may be located within the rights of way outside of the drip line of the conductor. All lighting standards and metallic objects within the right of way must be properly grounded to prevent exposure to induced currents and voltages per National Safety Code.
4. **High Pressure Valves:** Fire hydrants, air release valves, back flow preventers, PIV's, or any other high pressure valves shall not be designed to be within the rights of way.
5. **Manholes:** Below ground manholes (sewer, water, CATV, etc.) shall not be designed to be within the rights of way.
6. **Structures:** No permanent buildings or structures are allowed within transmission right of way.

VEGETATION

Supplemental planting, re-vegetation or mitigation measures will not be placed in, or interfere with SDG&E's existing access roads or existing cleared work areas such as maintenance pads. The developer or landowner will verify the location of existing access roads and work areas with SDG&E and submit a plan for review and approval prior to installing any supplemental planting, re-vegetation or mitigation in SDG&E rights of way.

1. **Supplemental Planting:** SDG&E's rights of way can be used for supplemental planting purposes if provided with the following items:

- A biological report describing the quality of the existing vegetation and/or habitat located within SDG&E's rights of way, and
 - A letter from the governing body requiring the developer to plant within SDG&E's rights of way and stating the additional vegetation is not part of the environmental mitigation requirements.
2. **Clearances:** No trees shall be planted within 10 feet (horizontally) of any conductor or within working spaces and maintenance pads. A working zone is required around any structure as indicated on Standards Page 11860 (01 through 06). These areas must be kept clear of any obstructions.
 3. **Irrigation:** Irrigation systems shall not spray directly onto any gas or electric facilities, access roads or maintenance pads.
 4. **Access:** Planted vegetation shall not restrict SDG&E's access to any of its facilities.
 5. **Vegetation Species:** Only trees and low growing vegetation with a mature height of 15 feet or less shall be permitted within SDG&E's rights of way. The following tree species are offered as examples of trees with a mature height typically not exceeding 15 feet. However, this is not an exhaustive list and SDG&E may consider other tree species when landscape plans for the proposed rights of way planting is prepared by a licensed landscape architect with written approval from SDG&E for use of a tree species not contained in the following list:

ACACIA cultriformis, Knife Acacia

FOLIAGE: Evergreen – Gray leaves

HEIGHT: Fast growing to 10 – 15'.

FLOWER: Yellow flowers Jan. – Mar.

COMMENTS: Best in full sun. Tolerates wind, drought and most soils.

CEANOTHUS 'Frosty Blue' or 'Ray Hartman'

FOLIAGE: Evergreen – Dark green leaves.

HEIGHT: Moderate growth to 8 – 15'.

FLOWER: Deep blue flowers Mar. – May.

COMMENTS: Best in full sun. Drought tolerant, needs hose water through the first season. Short lived +-10 years. Needs a well drained soil.

CERCIS occidentalis, Western Redbud (Calif. native)

FOLIAGE: Deciduous – Leaves are round & medium green.

HEIGHT: Moderate growth to 15'.

FLOWER: Magenta – Blooms March to April.

COMMENTS: Grows in full sun or part shade. Needs a well drained soil.

DODONAEA viscosa 'Pururea', Purple Hopbush

FOLIAGE: Evergreen – Willow like bronzy/purple green leaves. Foliage a deeper purple in full sun, more green in shade.
HEIGHT: Fast growing to 12 – 15'.
FLOWER: Insignificant.
COMMENTS: Drought tolerant. Tolerates any soil, wind and heat.

EUCALYPTUS priessiana, Bell Fruited Mallee

FOLIAGE: Evergreen – Gray green leaves.
HEIGHT: Moderate growth to 15'
FLOWER: Yellow flower – Blooms Jan. – Mar.
COMMENTS: Drought tolerant. Tolerates most soils.

LAVATERA assurgentiflora, Tree Mallow (Drought tolerant)

FOLIAGE: Evergreen – Maple like medium green leaves.
HEIGHT: Fast growth to 12'.
FLOWER: Lavender – Blooms year round.
COMMENTS: Grow in full sun. Tolerates drought & poor soil.

MAGNOLIA loebneri

FOLIAGE: Deciduous – Medium green leaves.
HEIGHT: Slow growing to 12 – 15'.
FLOWER: White, Blooms in the spring.
COMMENTS: Grow in sun to part shade. Needs moist, well drained, rich soil.

MAGNOLIA stellata, Star Magnolia

FOLIAGE: Deciduous – Medium green leaves.
HEIGHT: Slow growing to 10'.
FLOWER: White flower. Blooms in the spring.
COMMENTS: Grow in full sun to part shade. Needs moist, well drained, rich soil.

PHOTINIA fraseri

FOLIAGE: Evergreen – Glossy dark green leaves, bronzy new growth.
HEIGHT: Moderate growing to 10'.
FLOWER: White flowers. Blooms in the early spring.
COMMENTS: Berries attractive to birds. Heat resistant and drought tolerant.

PHOTINIA villosa

FOLIAGE: Deciduous – Dark green leaves, pale gold new foliage. Bright red fall color.
HEIGHT: Moderate growth to 15'.
FLOWER: White flowers. Blooms in the spring.
COMMENTS: Grow in full sun and in good soil.

RHAPHIOLEPIS 'Majestic Beauty'

FOLIAGE: Evergreen – Dark green large leaves 4 inches long.
HEIGHT: - Moderate growth to 15'.
FLOWER: Light pink fragrant flowers. Blooms from late fall to late spring.
COMMENTS: Grow in full sun to light shade. Drought tolerant. Tolerates many soil types.

RHUS integrifolia, Lemonade Berry

FOLIAGE: Evergreen – Dark green leaves.
HEIGHT: Moderate growth to 15'.
FLOWER: Pink to white flower. Blooms Feb. – Mar.
COMMENTS: Tolerates wind and drought. Best in a well drained soil.

RHUS ovata, Sugar Bush

FOLIAGE: Evergreen – Glossy dark green leaves.
HEIGHT: Moderate growth to 12'.
FLOWER: White and pink flower. Blooms Mar. to May.
COMMENTS: Tolerates heat and drought. Best in a well drained soil.

THEVETIA thevetiodes, Giant Thevetia (Drought tolerant)
FOLIAGE: Evergreen – Long narrow, glossy, dark green leaves.
HEIGHT: Fast growth to 12'.
FLOWER: Bright yellow, 4". – Blooms from June into winter.
COMMENTS: Best in full sun. They are related to oleander's &, as with oleander, are poisonous.

ACCESS AND ENCROACHMENT DOCUMENTS

Below is a summary of the various documents required for access to or the placement of encroachments in SDG&E's transmission rights of way. The fee schedule will be provided separately and is subject to change.

Permission to Grade Letter – Easement/Fee: Grants a developer of private property permission to grade within SDG&E's rights of way. Permission to Grade Letters will be issued once submitted plans have been reviewed and approved by SDG&E. The fee for issuing a Permission to Grade Letter is dependent upon the amount of review required.

Consent Letter - Recorded/Unrecorded: Grants permission for the use of SDG&E's easement for minor encroachments upon review and approval by SDG&E.

Rights of Way Use Agreement – Recorded: This agreement provides for multiple use of SDG&E's easements for uses compatible with SDG&E's existing and proposed future facilities.

Signature Omission Letter: This letter is provided to developers in compliance with the Subdivision Map Act. It is required when SDG&E has a recorded interest in the property being developed and does not object to the recordation of the map submitted by the requester. There is no charge for providing this letter.

Street Crossing: This fee covers SDG&E's future increased cost of operations caused by new street crossings. This includes the loss of easement rights, the cost of bridging required during overhead stringing operations, the cost for cutting, removal and replacement of curbs, sidewalks and associated paving required for existing or future underground electric or gas repairs or installations. Consideration is given to the width, angle, slopes, and any unique design of the street crossing that may impact SDG&E's operations.

Joint Use Agreement: This agreement is for the joint use and occupancy of SDG&E easements by other utilities' facilities. These facilities generally include, but are not limited to, sewer, water, roads, and phone systems. The fee for Joint

Use Agreements is dependent upon reciprocal no-charge policies by those agencies requesting Joint Use Agreements, the amount of work involved, and any concessions or betterments to the easement the agency is willing to grant.

Public Utility Letter: This letter is generally requested by a property owner to comply with a public agency's requirement. After determining that SDG&E has no facilities located in the public utility easement or any facilities not in conflict with the proposed improvement as shown on submitted maps, SDG&E will issue a letter stating there is no objection to the proposed construction of the project.

Right of Entry Permit: This letter grants permission to utilize SDG&E's rights of way in some temporary fashion.

Requests for Information: There is no charge for providing information to title companies or other utility companies who reciprocate in kind with the availability of information. For brokers or real estate salespersons, or other parties requesting information (title information) – there is an hourly fee.

Quitclaims: Quitclaims are the relinquishment of an interest in a particular easement crossing property not owned by SDG&E.

RELOCATION OF TRANSMISSION FACILITIES

Relocation of transmission facilities is a complex and costly undertaking. All costs are borne by the applicant. Engineering, special order of material, right of way documents, and construction lead times often exceed twelve (12) months. In most cases, early planning with SDG&E can provide alternatives to relocation.

It is SDG&E's policy to relocate transmission facilities and rights of way only when:

1. No practical alternatives exist.
2. The proposed rights of way alignment is equal to or better than the original rights of way.

All replacement easements will be documented on current forms. Current widths of easements for single structure are as follows:

Underground facilities	= 20' minimum
69kV (wood)	= 24' minimum
138kV (wood)	= 24' minimum
138kV (steel pole)	= 100' minimum
138kV (steel lattice)	= 100' minimum

230kV (steel pole)	= 120' minimum
230kV (steel lattice)	= 120' minimum
500kV (steel pole)	= 200' minimum
500kV (steel lattice)	= 200' minimum

3. No rights of way from property owners other than the developer are required.
4. The new alignment would allow ultimate development of the rights of way including full access to, from, and along.
5. All relocation costs will be paid by the developer, including but not limited to:
 - a. Engineering fees
 - b. Actual cost of relocating existing facilities.
 - c. Differential cost of future construction.
 - d. Additional operating and maintenance cost for the theoretical life of the newly constructed line.
 - e. Line loss costs for the additional line length for the theoretical life of the relocated facility.
 - f. Federal and State tax.
 - g. Collection of any incremental land values based on appraised values.

It is SDG&E's desire to offer assistance in the early planning stages of an applicant's project so satisfactory solutions can be reached. For information or assistance, contact the Planning Department at the SDG&E Service Center nearest you.

ENCROACHMENT ON 500 kV TRANSMISSION RIGHT OF WAY

Encroachment of San Diego Gas and Electric 500 kV transmission right of way requires special considerations due the special maintenance, access, and safety concerns. Each request for use of easements for SDG&E's 500 kV right of way will be reviewed on a case by case basis. Potential uses that will be considered within the 500KV corridor are road crossings both private and public, passive open space areas, golf courses, agriculture uses and parking lots. All these and other uses SDG&E deems compatible will be allowed using a *Right of Way Use Agreement* which is recorded against the subject property and is revocable under California Public Utility Commission General Order 69C.

The following limitations are considered when reviewing requests for encroachment or use of SDG&E's 500kV right of way:

1. **Permanent Structures:** No permanent structures will be allowed within the 500 kV transmission Right of Way.
2. **Temporary Structures:** Any requests for a temporary structure within the 500 kV right of way will be reviewed by Transmission Engineering. All temporary structures must have electrical grounds installed from conductive parts of the building in at least two locations such as the rain gutter or roof (if the roof is metal).
3. **Grading:** All requests for grading within the 500 kV right of way shall be reviewed on a case by case basis. All requests must comply with the Grading requirements described in section 3 of these guidelines, at a minimum.
4. **Clearances:** Minimum clearance from ground to any transmission conductor of 500kV shall not be less than forty (40) feet when the conductor is at maximum designed sag as shown on the SDG&E design profiles. Clearance shall not be calculated using "everyday" sag. The sag differential can vary significantly between "everyday" and "maximum design" sags, depending on load current and ambient conditions.
5. **Roads and Drainage:** Any request for modification of access roads within SDG&E's 500 kV right of way shall be designed and constructed by SDG&E.

Any other structure or requested modification of SDG&E's 500 kV right of way shall be reviewed by SDG&E Transmission Engineering. Considerations shall include:

- Maintaining acceptable levels of induced currents as defined by the National Electrical Safety Code and other applicable industry practices.
- Maintaining acceptable levels of step voltages.
- Physical safety hazards to the public.
- Possible contact of SDG&E facilities by vehicles or equipment.
- Providing access for maintenance of SDG&E transmission towers, poles, and other facilities.

ELECTRIC TRANSMISSION UNDERGROUND

1. **Improvements:** All improvements involving electric transmission underground in SDG&E easements must be approved by the Transmission Engineering Section of the Electrical Engineering Department prior to start of work. In addition, a letter of permission must be obtained from SDG&E's Land Management Department.

2. **Restrictions:** The following restrictions are listed to aid in the Developer's design of improvements and are not restricted to the items noted.
3. **Encroachment:** Crossing an electric transmission underground trench line or manhole with heavy equipment requires prior SDG&E approval.
4. **Cover:** Minimum required cover over transmission underground is 36" to top of conduit.
5. **Fill:** Maximum fill allowed over transmission underground is 48" to top of conduit. In some cases, with prior SDG&E approval, minimal additional fill may be allowed for a limited distance.
6. **Manholes:** No fill is allowed over transmission manholes or handholes.
7. **Crossings:** All utility crossings should be as close to 90° as possible with an 18" vertical separation.
8. **Separation:** A minimum of 60" horizontal separation should be maintained.
9. **Restrictions:** The following are not allowed in an Underground Easement;
 - a. Distribution or Foreign Utilities.
 - b. Distribution or Foreign Utility manholes or padmounts.
 - c. Drainage outlets.
 - d. Drainage culverts.
 - e. Multiple sprinkler crossings.
 - f. Sprinkler heads.
 - g. Permanent structures.
10. **Slopes:** No fill slopes or cut slopes will be allowed within the Underground Easement.
11. **Erosion:** No temporary or permanent ponding of water or possible water erosion will be allowed within the Underground Easement.
12. **Access:** No trees are to be planted within the underground easement. Ground cover will be allowed, but SDG&E vehicle access must be maintained to and along the underground easement.

Approved By: 
D. Korinek, Manager
Transmission Planning

Approved By: 
W.V. Torre, Manager
Transmission Engineering

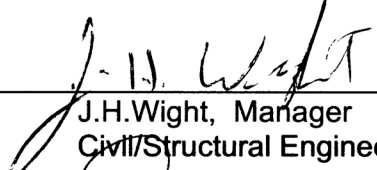
Approved By: 
J.H. Wight, Manager
Civil/Structural Engineering

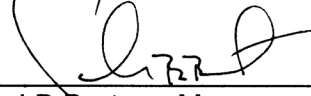
Approved By: 
J.B. Burton, Manager
Land Rights Acquisition & Land Management

Approved By: 
E. Dino Dimuzio, Manager
Operations & Maintenance Services

APPENDIX

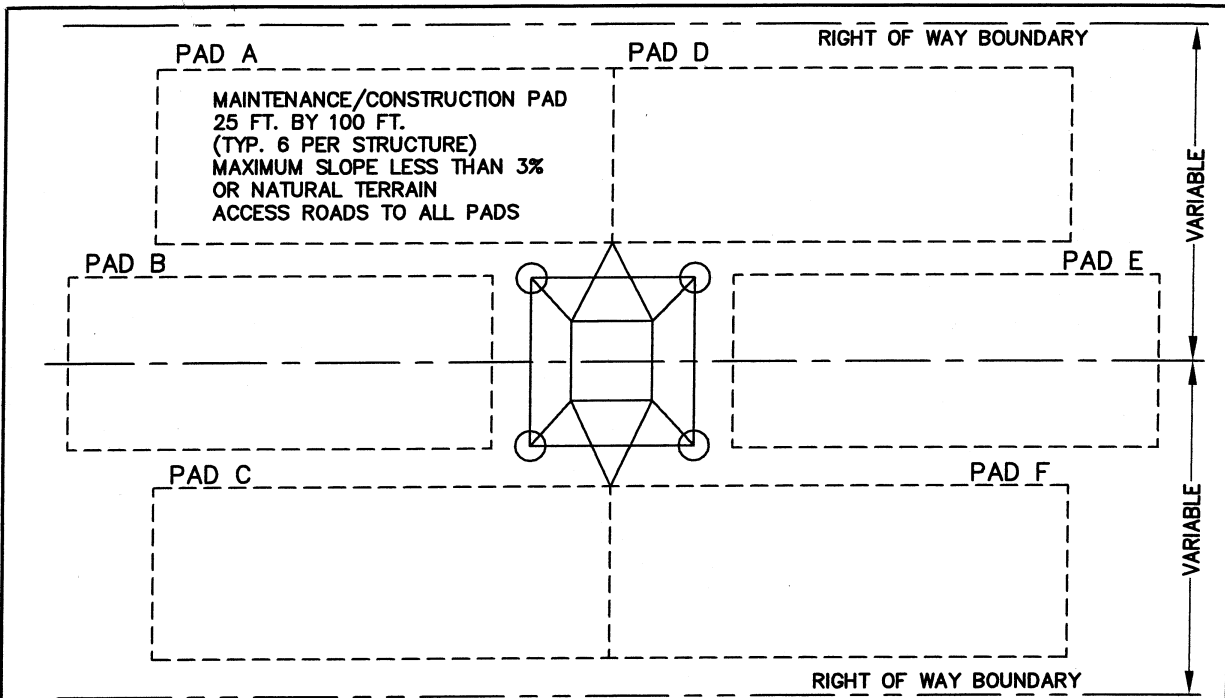

**MAINTENANCE PAD REQUIREMENTS
(IF CONCRETE OR ASPHALT USE HS20 DESIGN)**

WORKING SPACE
20 FT. MINIMUM
MAXIMUM SLOPE = 3%
OR NATURAL TERRAIN
NO OBSTRUCTIONS ALLOWED

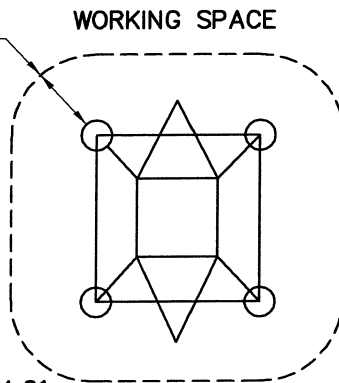

NOTE:
1. SUPERSEDES DWG. # TA3604.01

B								
A								
				ORIGINAL	WDF	<i>SAC</i>	<i>WVT</i>	<i>10/2/01</i>
REV	BUDGET	CONST ORDER		CHANGE	DWN	CHKD	APPV	APPV

	SAN DIEGO GAS & ELECTRIC TRANSMISSION ENGINEERING	MISC. DETAILS MAINTENANCE & WORKING PADS LATTICE TOWERS GUIDE FOR ENCROACHMENT	
		SCALE: NONE	11860-01

SHEET 1 OF 6

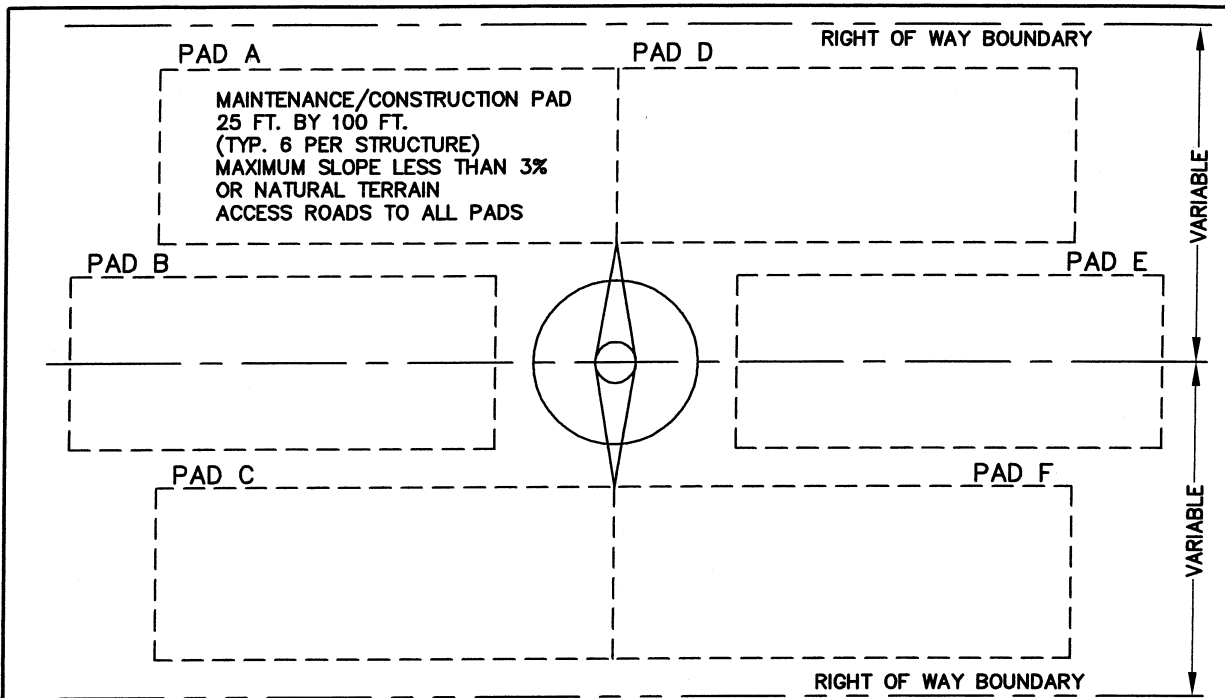

MAINTENANCE PAD REQUIREMENTS
(IF CONCRETE OR ASPHALT USE HS20 DESIGN)

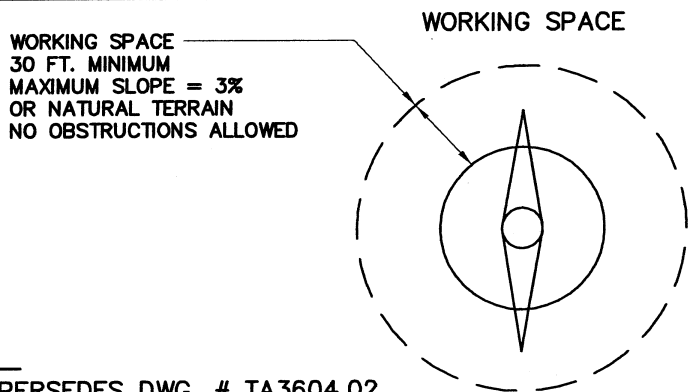

NOTE:

- 1. SUPERSEDES DWG. # TA3604.02

B									
A									
				ORIGINAL	WDF	<i>Sato</i>	<i>WRT</i>		10/9/01
REV	BUDGET	CONST ORDER		CHANGE	DWN	CHKD	APPV	APPV	DATE



SAN DIEGO GAS & ELECTRIC
TRANSMISSION ENGINEERING

MISC. DETAILS
MAINTENANCE & WORKING PADS
TUBULAR STEEL POLES
GUIDE FOR ENCROACHMENT

SCALE: NONE
SHEET 2 OF 6

11860-02

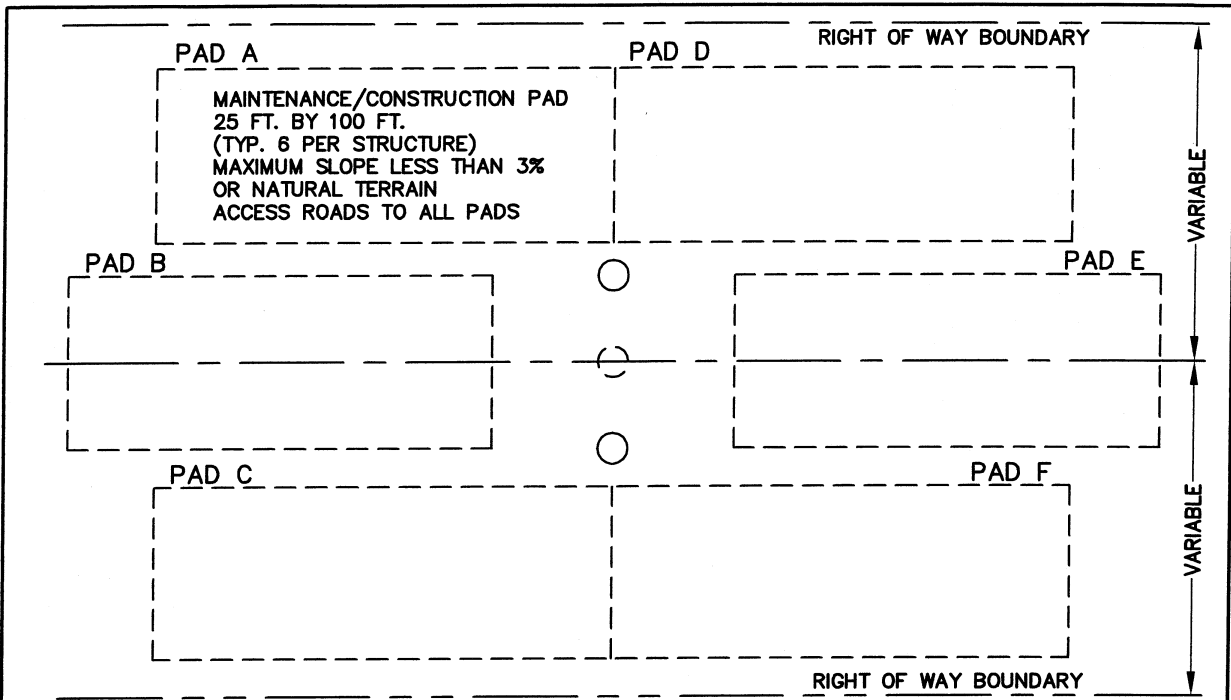

MAINTENANCE PAD REQUIREMENTS
 (IF CONCRETE OR ASPHALT USE HS20 DESIGN)

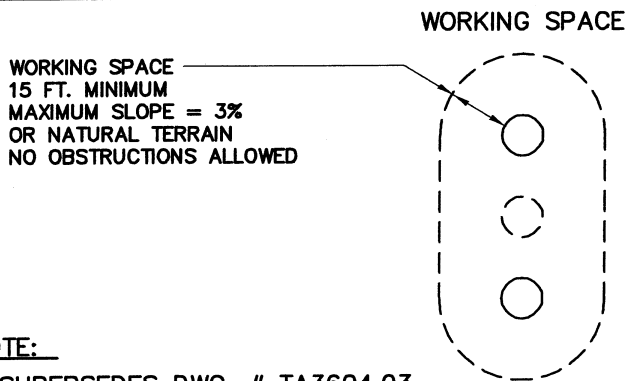

B									
A									
			ORIGINAL	WDF	SAC	WVT			10/9/81
REV	BUDGET	CONST ORDER	CHANGE	DWN	CHKD	APPV	APPV		DATE

	SAN DIEGO GAS & ELECTRIC TRANSMISSION ENGINEERING	MISC. DETAILS MAINTENANCE & WORKING PADS MULTIPLE WOOD POLE STRUCTURES GUIDE FOR ENCROACHMENT	
		SCALE: NONE SHEET 3 OF 6	

11860-03

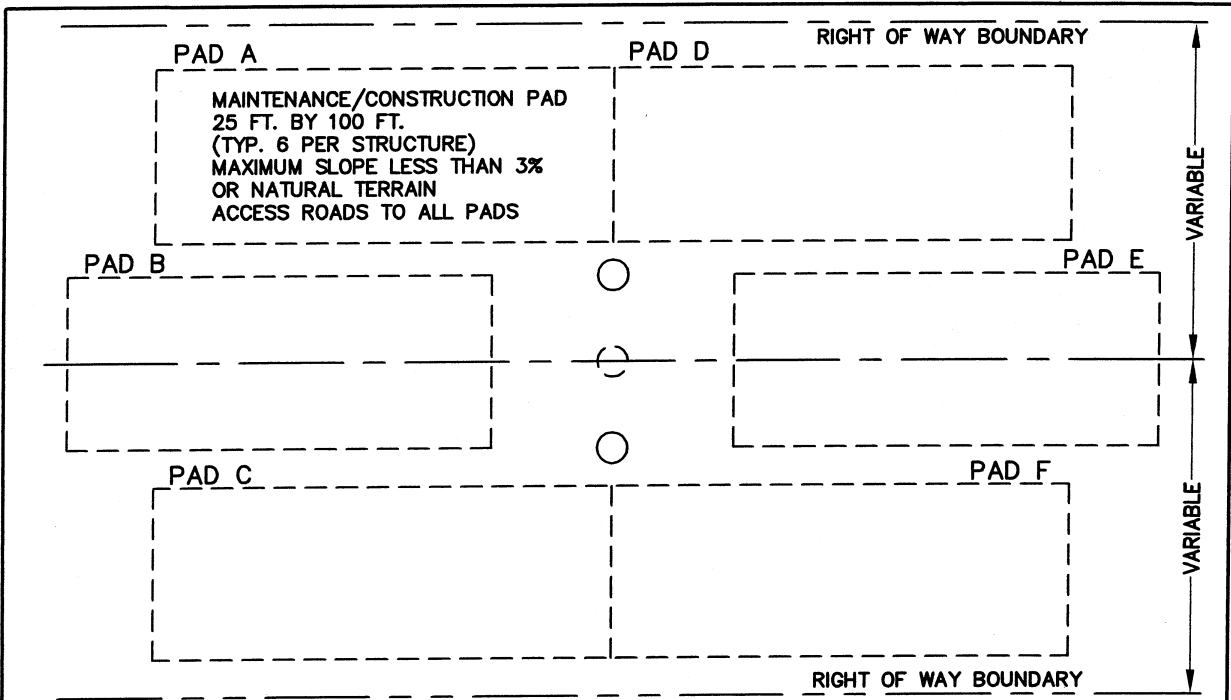

MAINTENANCE PAD REQUIREMENTS
 (IF CONCRETE OR ASPHALT USE HS20 DESIGN)

WORKING SPACE

WORKING SPACE
 10 FT. MINIMUM
 MAXIMUM SLOPE = 3%
 OR NATURAL TERRAIN
 NO OBSTRUCTIONS ALLOWED

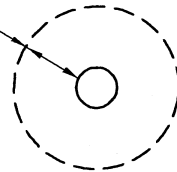

NOTE:

1. SUPERSEDES DWG. # TA3604.04

B									
A									
				ORIGINAL	WDF	SAB	WYT		10/2/01
REV	BUDGET	CONST ORDER		CHANGE	DWN	CHKD	APPV	APPV	DATE
				SAN DIEGO GAS & ELECTRIC TRANSMISSION ENGINEERING		MISC. DETAILS MAINTENANCE & WORKING PADS SINGLE WOOD POLE STRUCTURES GUIDE FOR ENCROACHMENT			
				SCALE: NONE					
				SHEET 4 OF 6		11860-04			

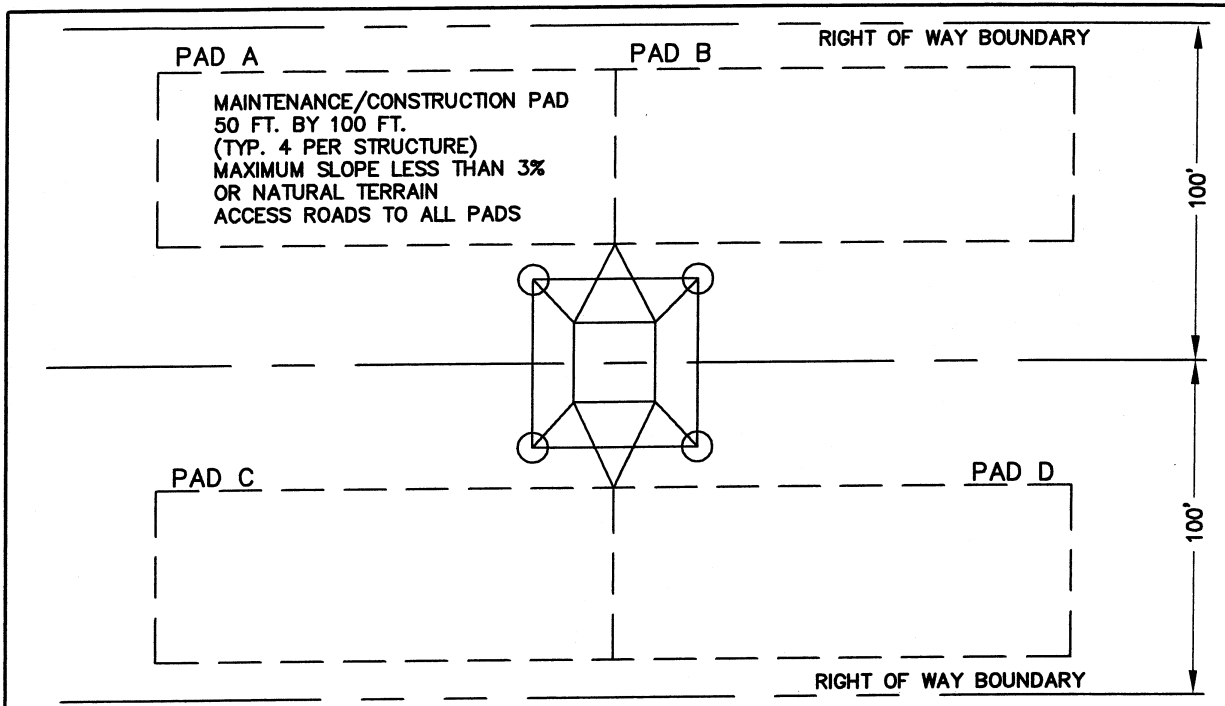

MAINTENANCE PAD REQUIREMENTS
(IF CONCRETE OR ASPHALT USE HS20 DESIGN)

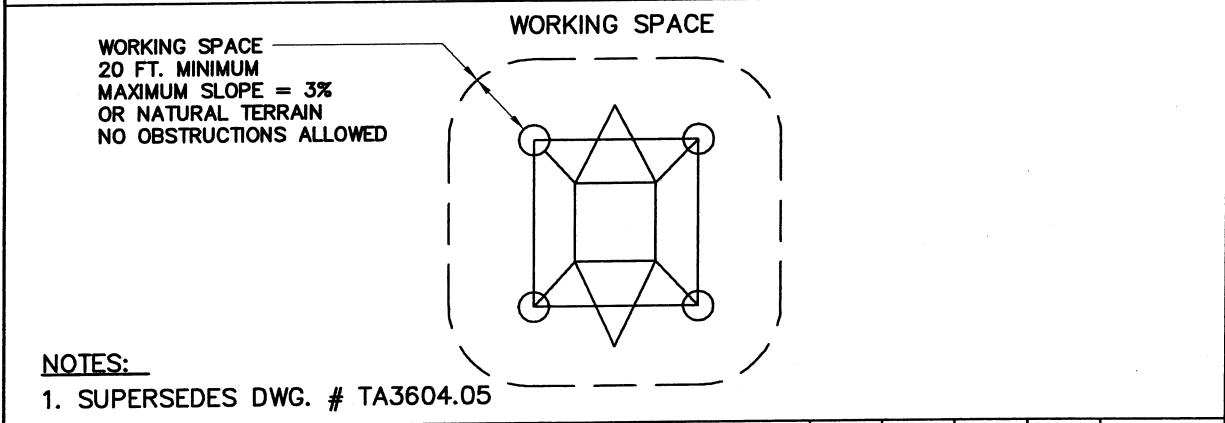

NOTES:

1. SUPERSEDES DWG. # TA3604.05

B								
A								
			ORIGINAL		WDF	SAC	WRT	10/9/01
REV	BUDGET	CONST ORDER	CHANGE		DWN	CHKD	APPV	APPV

	SAN DIEGO GAS & ELECTRIC TRANSMISSION ENGINEERING	MISC. DETAILS MAINTENANCE & WORKING PADS 500KV LATTICE TOWERS GUIDE FOR ENCROACHMENT	
		SCALE: NONE SHEET 5 OF 6	11860-05

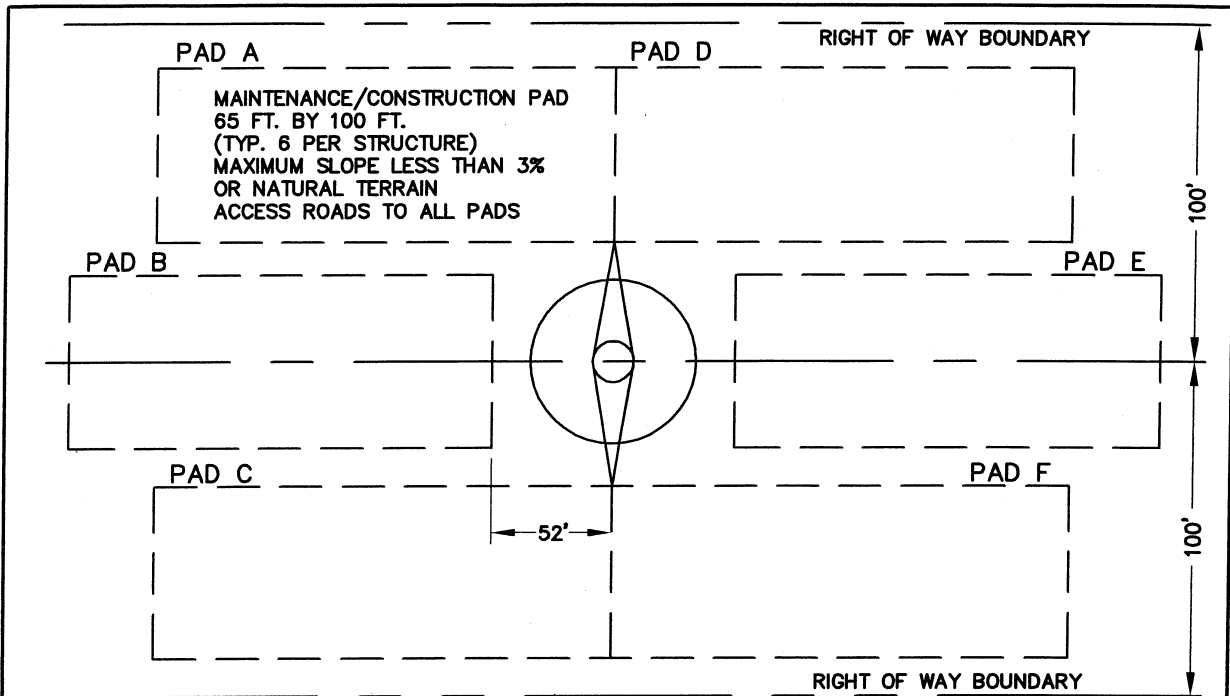

MAINTENANCE PAD REQUIREMENTS
(IF CONCRETE OR ASPHALT USE HS20 DESIGN)

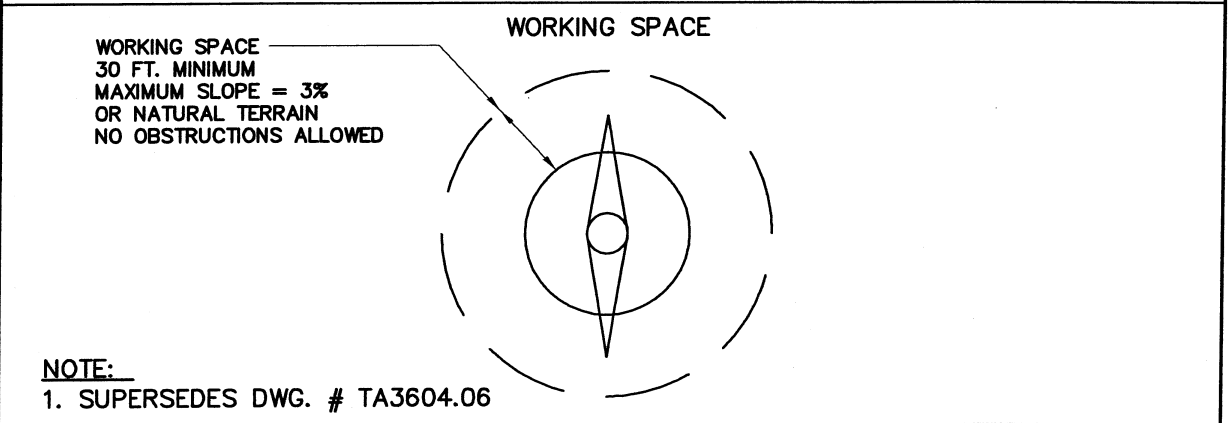

B								
A								
				ORIGINAL	WDF	<i>Sal</i>	<i>lv7</i>	<i>10/4/01</i>
REV	BUDGET	CONST ORDER	CHANGE	DWN	CHKD	APPV	APPV	DATE

 SAN DIEGO GAS & ELECTRIC TRANSMISSION ENGINEERING	MISC. DETAILS MAINTENANCE & WORKING PADS 500KV TUBULAR STEEL POLES GUIDE FOR ENCROACHMENT	
	SCALE: NONE SHEET 6 OF 6	11860-06

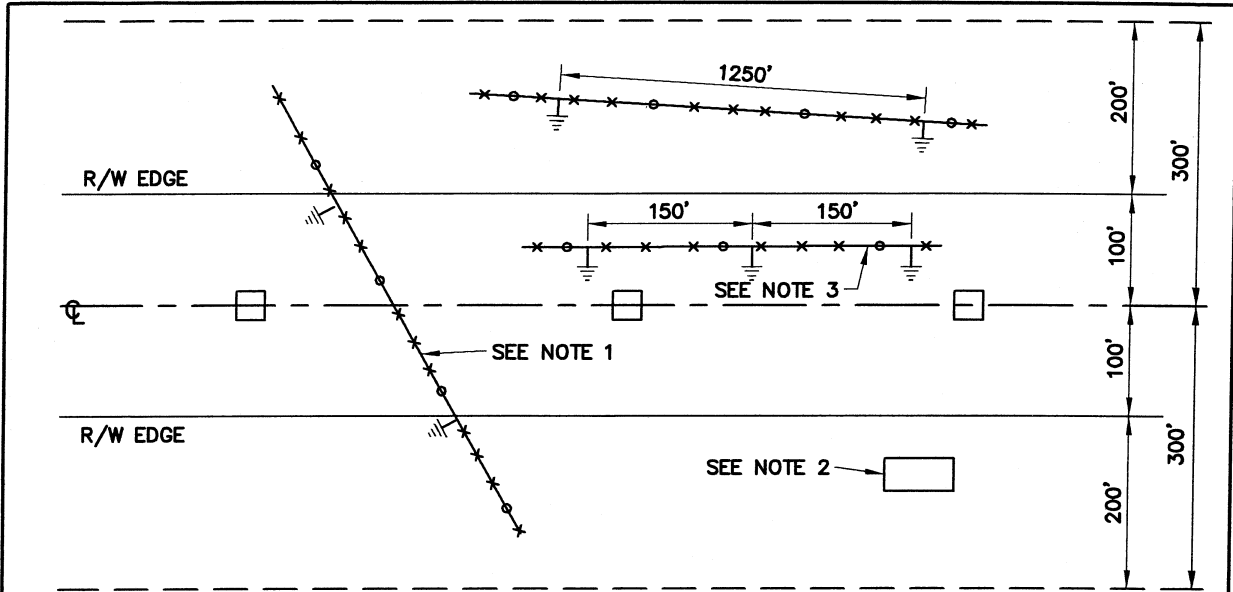

NOTES:

1. FENCES CROSSING THE TRANSMISSION LINE AT AN ANGLE GREATER THAN 30°, ONE GROUND SHALL BE INSTALLED WHERE THEY ENTER & EXIT THE RIGHT- OF- WAY.
2. METALLIC STRUCTURES WITHIN 200 FEET OF THE EDGE OF THE RIGHT-OF-WAY SHALL BE GROUNDED.
3. FENCES WITHIN THE RIGHT-OF-WAY WILL BE GROUNDED AT 150 FOOT INTERVALS & WHERE THEY ENTER & EXIT THE RIGHT-OF-WAY.
4. FENCES WITHIN 200 FEET OF THE EDGE OF THE RIGHT-OF-WAY CROSSING AT AN ANGLE OF LESS THAN 30° OR PARALLEL TO THE TRANSMISSION LINE SHALL BE GROUNDED AT 1250 FOOT INTERVALS.
5. SUPERSEDES DWG. # TA2501

B								
A								
				ORIGINAL	WDF	<i>SAT</i>	<i>WVT</i>	<i>10/9/01</i>
REV	BUDGET	CONST ORDER		CHANGE	DWN	CHKD	APPV	APPV

SAN DIEGO GAS & ELECTRIC TRANSMISSION ENGINEERING	GROUNDING GROUNDING REQUIREMENTS	
	SCALE: NONE SHEET 1 OF 4	11861-01

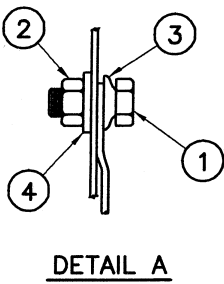
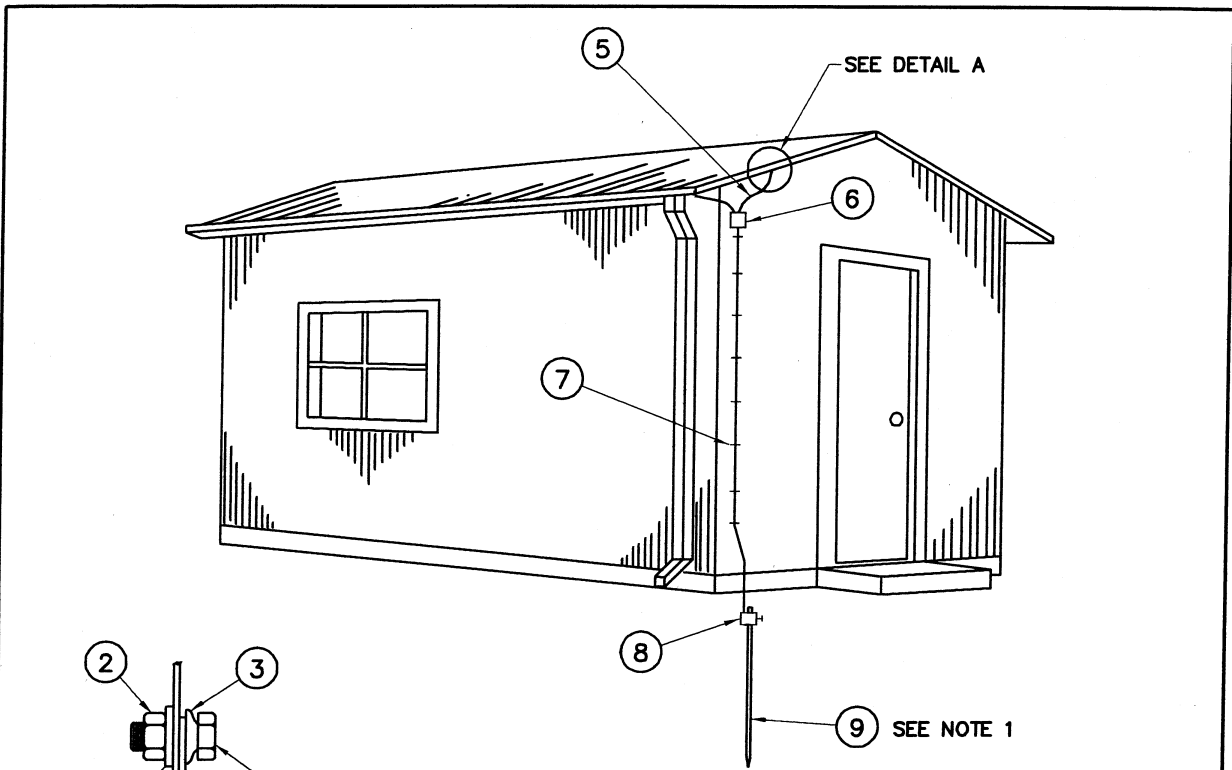

ITEM	DESCRIPTION
1	BOLT, 1/4" x 1" STAINLESS STEEL
2	NUT, 1/4" STAINLESS STEEL
3	WASHER, BELLEVILLE, 1/4" STAINLESS STEEL
4	WASHER, FLAT, 1/4" STAINLESS STEEL
5	WIRE, 1/4", 3 STR. GALVANIZED STEEL
6	CONNECTOR, BURNDY CAT. NO. KSU 22 OR EQUIVALENT
7	CLIP, WIRE
8	CLAMP, GROUND ROD, 5/8" BURNDY CAT. NO. GKP 635 OR EQUIV.
9	GROUND ROD, 5/8" x 8' COPPERWELD

NOTE:

1. GROUND ROD TO BE INSTALLED 8" MIN. BELOW GRADE.
2. SUPERSEDES DWG. # TA2502

B								
A								
			ORIGINAL	WDF	<i>WDF</i>	<i>WDF</i>		<i>10/1/01</i>
REV	BUDGET	CONST ORDER	CHANGE	DWN	CHKD	APPV	APPV	DATE
 SAN DIEGO GAS & ELECTRIC TRANSMISSION ENGINEERING				GROUNDING METALLIC STRUCTURES (TYPICAL)				
				SCALE: NONE				
				SHEET 2 OF 4		11861-02		

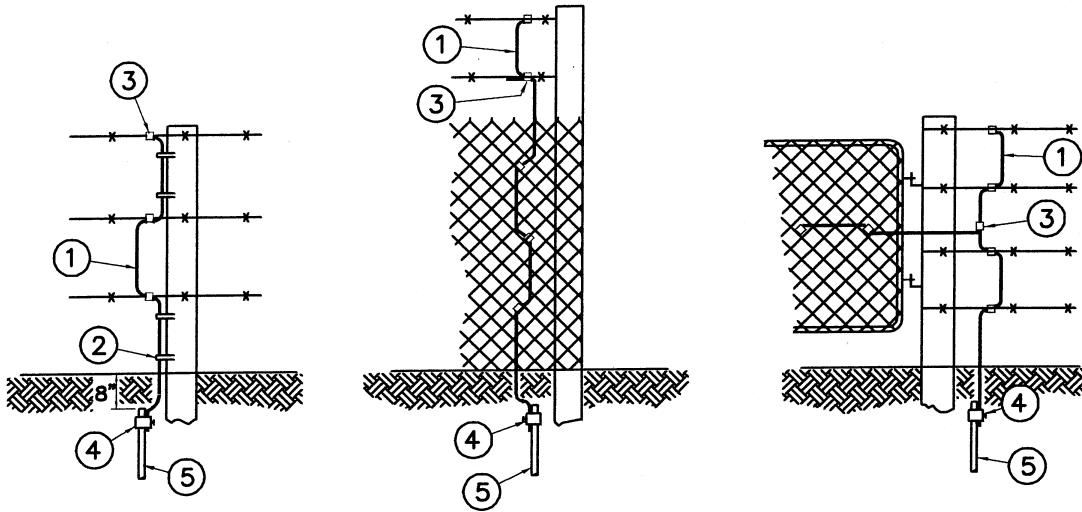

BILL OF MATERIALS	
ITEM	DESCRIPTION
1	WIRE, 1/4" 3 STR. GALVANIZED STEEL
2	FENCE STAPLE, 1 1/4" GALVANIZED
3	CONNECTOR, BURNDY TYPE KSU OR EQUIV., SIZE TO FIT
4	CLAMP, GROUND ROD, 5/8" BURNDY CAT. NO. GKP 635 OR EQUIV.
5	GROUND ROD, 5/8" x 8' COPPERWELD

NOTE:

1. SUSP. DWG. # TA2503

B								
A								
			ORIGINAL	WDF	<i>SAL WVT</i>			<i>10/16/01</i>
REV	BUDGET	CONST ORDER	CHANGE	DWN	CHKD	APPV	APPV	DATE
 SAN DIEGO GAS & ELECTRIC TRANSMISSION ENGINEERING				GROUNDING GATES & FENCES				
				SCALE: NONE				
				SHEET 3 OF 4		11861-03		

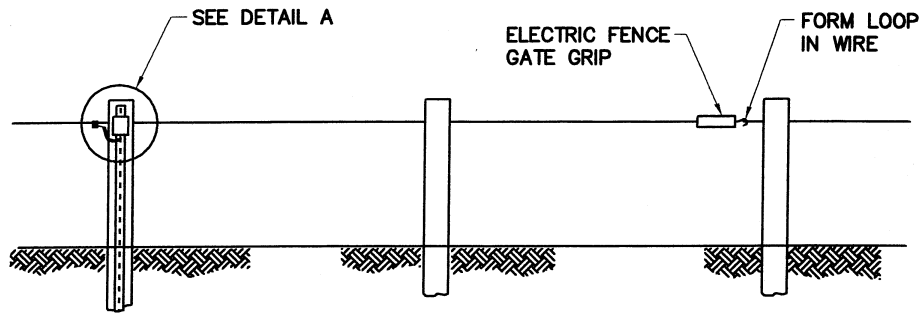

TYPICAL ELECTRIFIED WIRE FENCE

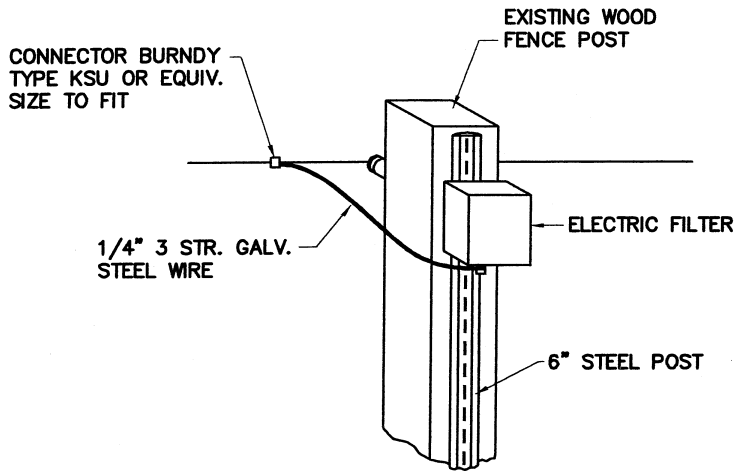

DETAIL A

NOTES:

1. 6' STEEL POST SHALL BE INSTALLED AS CLOSE TO EXISTING POST AS POSSIBLE. STEEL POST SHALL NOT BE INSTALLED IF EXISTING FENCE POST IS STEEL.
2. ELECTRIC FILTER SHALL BE AS FURNISHED BY SYNDYNE CORP. 2001 ROOSEVELT AVE., VANCOUVER, WASHINGTON 98660.
3. SUPERSEDES DWG. # TA2504

<i>B</i>								
<i>A</i>								
				ORIGINAL	WDF	<i>SAL</i>	<i>WIT</i>	<i>10/9/01</i>
REV	BUDGET	CONST ORDER		CHANGE	DWN	CHKD	APPV	APPV DATE
 SAN DIEGO GAS & ELECTRIC TRANSMISSION ENGINEERING				GROUNDING ELECTRIC FENCES				
				SCALE: NONE				
			SHEET 4 OF 4					

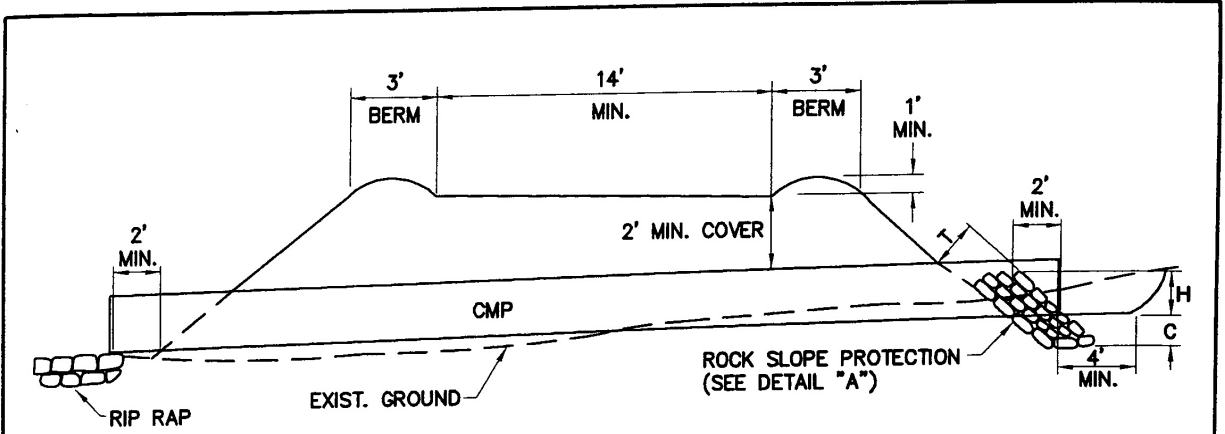

TYPICAL CULVERT INSTALLATION

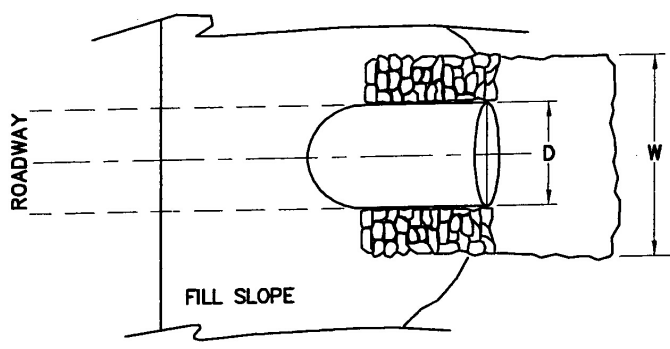

DETAIL "A"
ROCK SLOPE PROTECTION

NOTES:

1. * - 60% OF STONES SHALL BE STONE SIZE OR LARGER. 30% OF STONES MAY BE LESS THAN 1/5 STONE SIZE.
2. SUPERSEDES DWG. # TA2459

D	W	C	H
18"	3.5'	2.0'	1.0'
24"	4.5'	2.5'	1.0'
36"	5.0'	3.0'	1.5'
48"	8.0'	3.0'	2.0'
60"	11.0'	3.0'	3.0'

FL. SLP	STONE* SIZE	T
5%	NONE	—
10%	1.5'	2.0'
15%	2.5'	4.0'
20%	3.0'	5.0'

B									
A									
			ORIGINAL		WDF	<i>[Signature]</i>	WDF	10/16/01	
REV	BUDGET	CONST ORDER	CHANGE		DWN	CHKD	APPV	APPV	DATE
SAN DIEGO GAS & ELECTRIC TRANSMISSION ENGINEERING				ACCESS ROAD DETAILS CULVERTS					
				SCALE: NONE					
				SHEET 1 OF 10		11862-01			

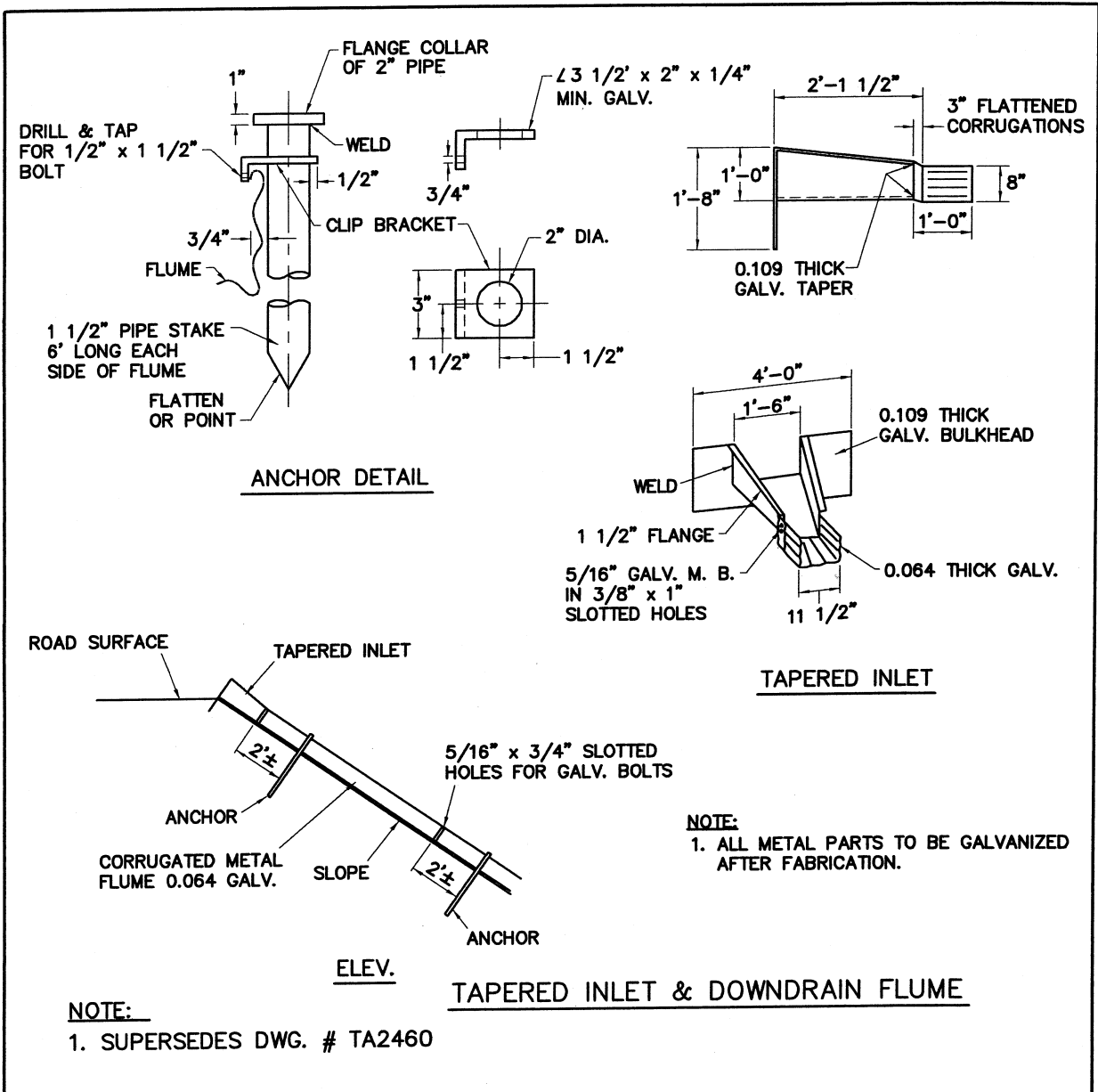

B								
A								
			ORIGINAL	WDF	<i>SAC</i>	<i>JAW</i>	<i>WVT</i>	<i>10/16/01</i>
REV	BUDGET	CONST ORDER	CHANGE	DWN	CHKD	APPV	APPV	DATE
SAN DIEGO GAS & ELECTRIC TRANSMISSION ENGINEERING				ACCESS ROAD DETAILS DOWN DRAINS				
				SCALE: NONE				
				SHEET 2 OF 10		11862-02		

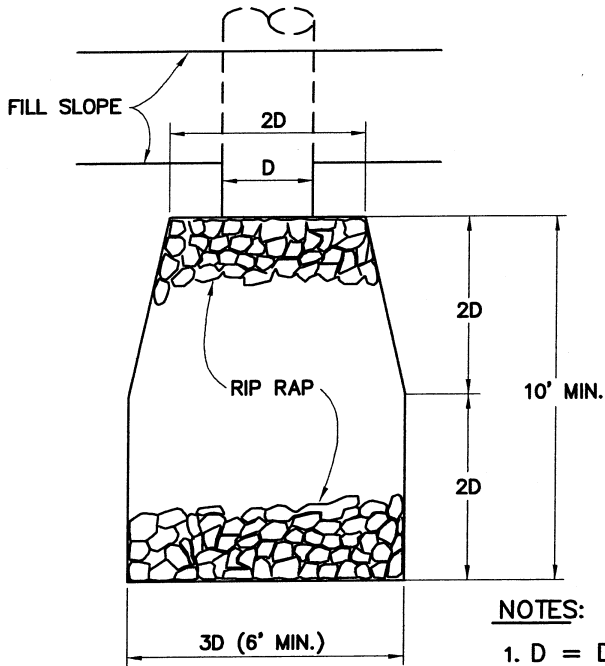

PLAN VIEW

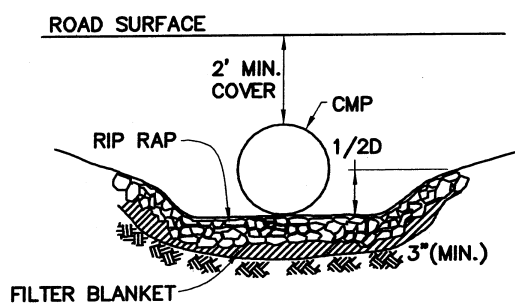

ELEVATION

NOTES:

1. D = DIAMETER
2. TYPE OF RIP RAP
 - A. REGULAR QUARRY STONE
 - B. BROKEN CONCRETE
3. PLACEMENT
 - A. MIN. DEPTH 1 1/2 TIMES AVERAGE STONE SIZE.
 - B. ROCKS SHALL BE PLACED SO AS TO PROVIDE A MIN. OF VOIDS.
 - C. SURFACE ROCKS OR CONCRETE SHALL PROTRUDE TO AT LEAST 1/2 THEIR VERTICAL DIMENSION.
 - D. RIP RAP SHALL BE PLACED OVER A FILTER BLANKET WHICH MAYBE EITHER GRANULAR MATERIAL OR FILTER CLOTH.
4. SUPERSEDES DWG. # TA2461

B									
A									
				ORIGINAL	WDF	<i>SAC</i>	<i>SWW</i>	<i>WRT</i>	<i>10/16/01</i>
REV	BUDGET	CONST ORDER		CHANGE	DWN	CHKD	APPV	APPV	DATE



SAN DIEGO GAS & ELECTRIC TRANSMISSION ENGINEERING

ACCESS ROAD DETAILS ENERGY DISSIPATOR

SCALE: NONE
SHEET 3 OF 10

11862-03

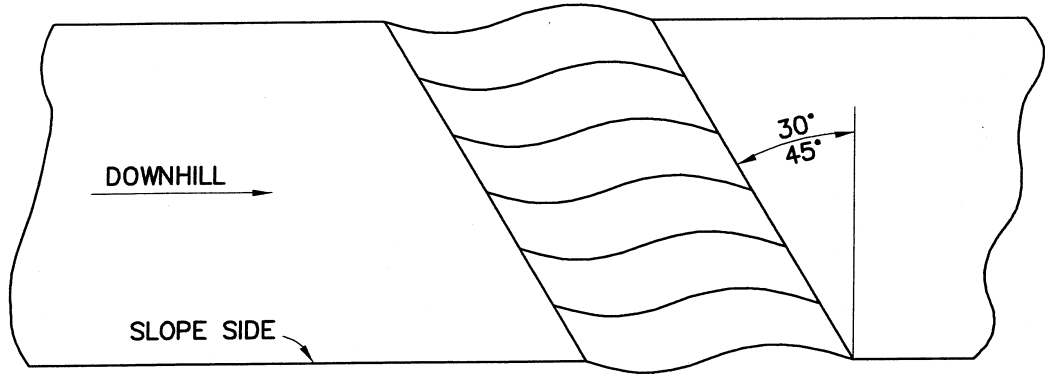

PLAN VIEW

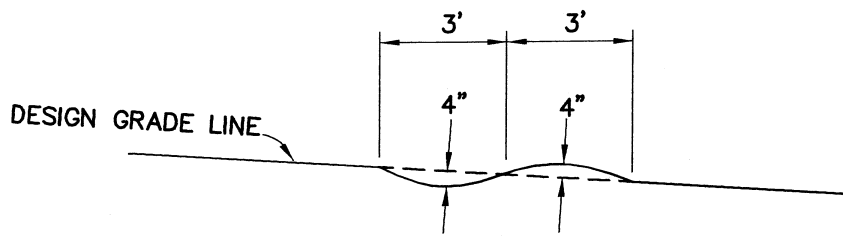

PROFILE

TYPICAL WATER BAR

NOTE:

1. THE RIDGE OF EACH WATER BAR IS TO BE MAINTAINED AT AN ELEVATION AT LEAST 4" ABOVE THE ADJACENT DEPRESSION.
2. SUPERSEDES DWG. # TA2462

B									
A									
			ORIGINAL		WDF	<i>SAC</i>	<i>SHW</i>	<i>WYT</i>	<i>10/16/03</i>
REV	BUDGET	CONST ORDER	CHANGE		DWN	CHKD	APPV	APPV	DATE
 SAN DIEGO GAS & ELECTRIC TRANSMISSION ENGINEERING				ACCESS ROAD DETAILS WATER BARS					
				SCALE: NONE					
				SHEET 4 OF 10		11862-04			

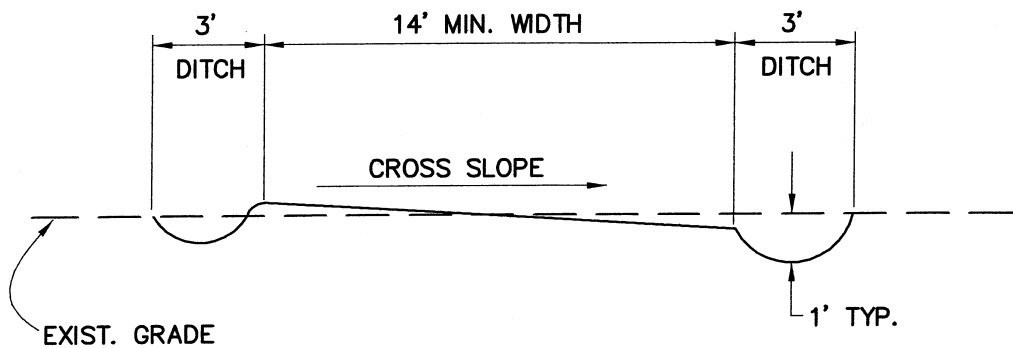

TYPICAL FLAT SECTION
20% MAX. EXIST. GRADE CROSS SLOPE

NOTE:

1. SEE DWG. 11862-10 FOR CROSS SLOPE
2. SUPERSEDES DWG. # 10232-01

B									
A									
				ORIGINAL	WDF	<i>[Signature]</i>	<i>[Signature]</i>	<i>[Signature]</i>	10/16/07
REV	BUDGET	CONST ORDER		CHANGE	DWN	CHKD	APPV	APPV	DATE
 SAN DIEGO GAS & ELECTRIC TRANSMISSION ENGINEERING					ACCESS ROAD DETAILS TYPICAL ROAD CROSS SECTION				
					SCALE: NONE				
					SHEET 5 OF 10		11862-05		

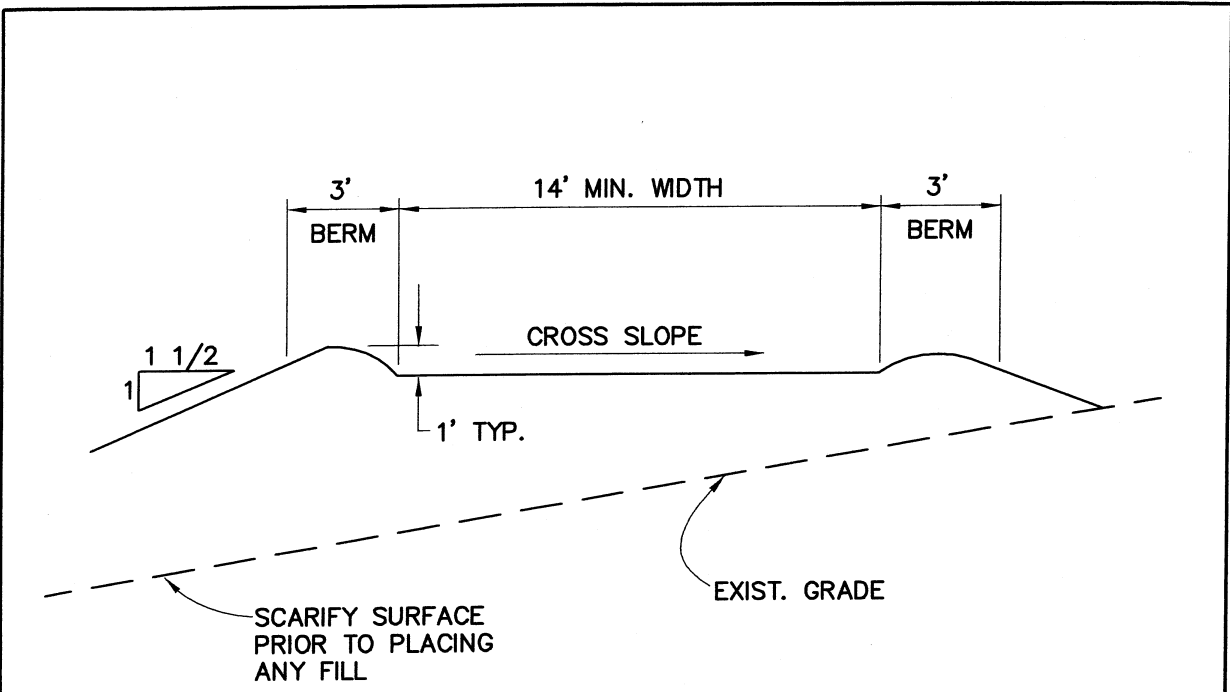

TYPICAL FULL FILL SECTION
40% MAX. EXIST. GRADE CROSS SLOPE

- NOTE:**
1. SEE DWG. 11862-10 FOR CROSS SLOPE
 2. SUPERSEDES DWG. # 10232-02

B									
A									
			ORIGINAL		WDF	<i>SAC</i>	<i>JHW</i>	<i>WY7</i>	<i>10/16/01</i>
REV	BUDGET	CONST ORDER	CHANGE	DWN	CHKD	APPV	APPV	DATE	
SAN DIEGO GAS & ELECTRIC TRANSMISSION ENGINEERING				ACCESS ROAD DETAILS TYPICAL ROAD CROSS SECTION					
				SCALE: NONE					
				SHEET 6 OF 10		11862-06			

CROSS SLOPE	"A" MIN.	"B" MIN.
0% - 40%	7'	7'
40% - 60%	10'	4'

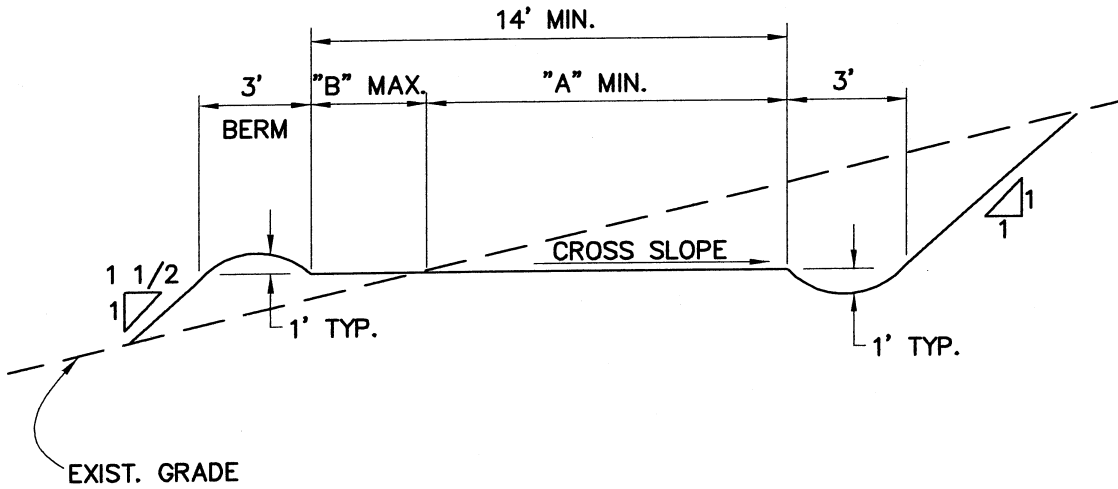

TYPICAL CUT-FILL SECTION
0-60% EXIST. GRADE CROSS SLOPE

NOTE:

1. CUT SLOPES MAY BE 1/2:1 IN SOLID ROCK.
2. SEE DWG. 11862-10 FOR CROSS SLOPE
3. SUPERSEDES DWG. # 10232-03

B									
A									
				ORIGINAL	WDF	<i>SAB</i>	<i>SWD</i>	WVT	10/16/01
REV	BUDGET	CONST ORDER		CHANGE	DWN	CHKD	APPV	APPV	DATE
				SAN DIEGO GAS & ELECTRIC TRANSMISSION ENGINEERING	ACCESS ROAD DETAILS TYPICAL ROAD CROSS SECTION				
				SCALE: NONE					
				SHEET 7 OF 10	11862-07				

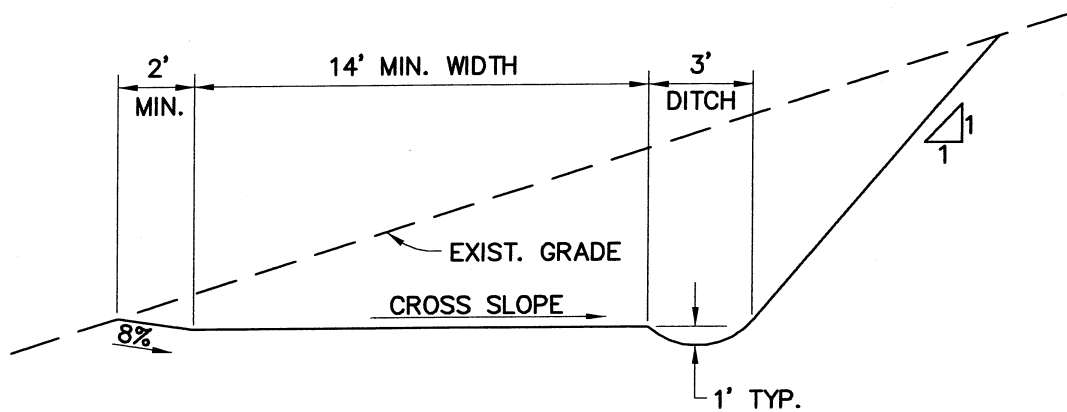

TYPICAL CUT-FILL SECTION
60-80% EXIST. GRADE CROSS SLOPE

NOTE:

1. CUT SLOPES MAY BE 1/2:1 IN SOLID ROCK.
2. SEE DWG. 11862-10 FOR CROSS SLOPE
3. EXCESS SOIL MAY BE SIDE CAST EXCEPT AS NOTED.
4. SUPERSEDES DWG. # 10232-04

B								
A								
			ORIGINAL		WDF	<i>[Signature]</i>	<i>[Signature]</i>	10/16/01
REV	BUDGET	CONST ORDER	CHANGE	DWN	CHKD	APPV	APPV	DATE
 SAN DIEGO GAS & ELECTRIC TRANSMISSION ENGINEERING				ACCESS ROAD DETAILS TYPICAL ROAD CROSS SECTION				
				SCALE: NONE				
				SHEET 8 OF 10		11862-08		

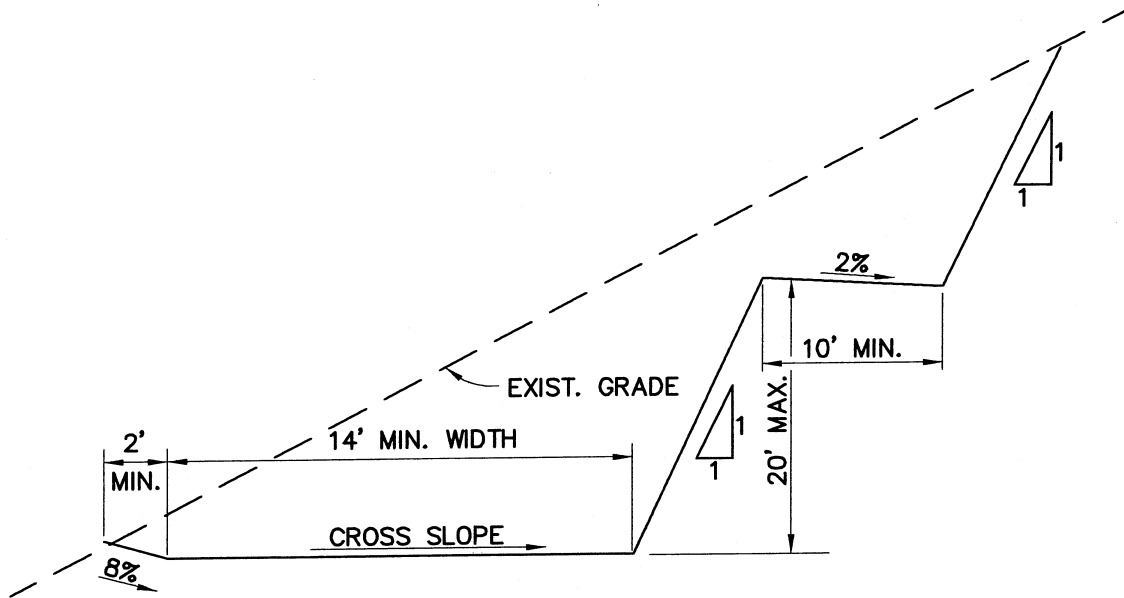

TYPICAL FULL CUT WITH BENCH SECTION
 ALL EXIST. GRADE CROSS SLOPES GREATER THAN 80%
 AND WHERE REQUIRED BY ENGINEER

NOTE:

1. CUT SLOPES MAY BE 1/2:1 IN SOLID ROCK.
2. SEE DWG. 11862-10 FOR CROSS SLOPE
3. EXCESS SOIL MAY BE SIDE CAST EXCEPT AS NOTED.
4. SUPERSEDES DWG. # 10232-05

B									
A									
				ORIGINAL	WDF	<i>[Signature]</i>	JAW	wvt	10/16/01
REV	BUDGET	CONST ORDER		CHANGE	DWN	CHKD	APPV	APPV	DATE
 SAN DIEGO GAS & ELECTRIC TRANSMISSION ENGINEERING				ACCESS ROAD DETAILS TYPICAL ROAD CROSS SECTION					
				SCALE: NONE					
				SHEET 9 OF 10		11862-09			

ROAD \bar{C} GRADE (PERCENT)	MINIMUM CROSS SLOPE TOWARD CUT BANK (PERCENT)	MINIMUM CROSS SLOPE AWAY FROM CUT BANK (PERCENT)
0 - 4	2	2
5 - 7	3	
8 - 10	4	
11 - 12	5	
13 - 15	6	
16 - 17	7	
18 - 20	8	

NOTE:

1. SUPERSEDES DWG. # 10232-06

B									
A									
				ORIGINAL	WDF	<i>WDF</i>	<i>SHS</i>	<i>WVT</i>	10/14/01
REV	BUDGET	CONST ORDER		CHANGE	DWN	CHKD	APPV	APPV	DATE
				SAN DIEGO GAS & ELECTRIC TRANSMISSION ENGINEERING	ACCESS ROAD DETAILS TYPICAL ROAD CROSS SECTION				
				SCALE: NONE					
				SHEET 10 OF 10	11862-10				