

SCALE: 1"=40'



LEGEND

- ED — UNDERGROUND ELECTRICAL LINE
- GT — GAS PIPELINE
- TSP
- STORM DRAIN INLET
- T — TELEPHONE
- W — WATER LINE
- SS — SANITARY SEWER
- SD — STORM DRAIN
- EXISTING POLE
- ← GUY WIRE

DETAIL A
NOT TO SCALE

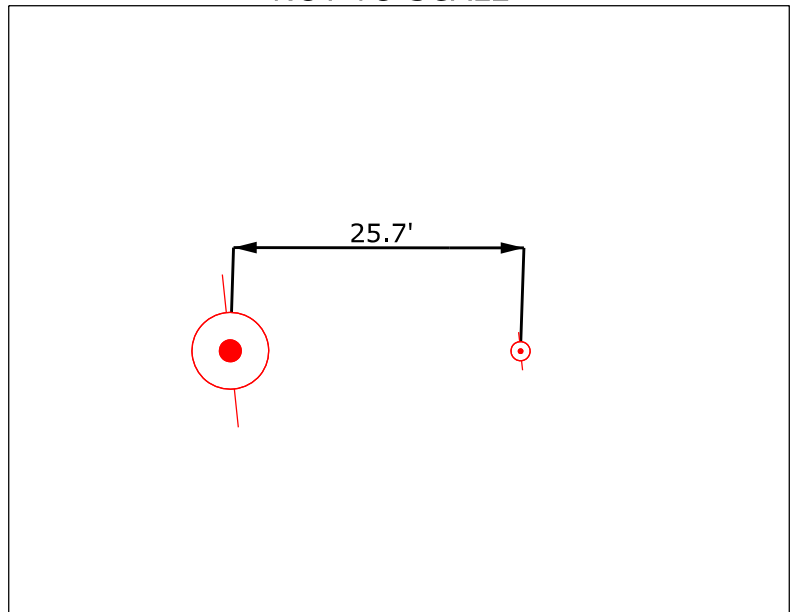

AUTHORIZATION 74000600	
BY	F3
DR	J82I
CH	WDCF
O.K.	PXGE
DATE	JAN 2019

FULTON-FITCH

PROJECT NUMBER 23

PACIFIC GAS AND ELECTRIC COMPANY
San Francisco California



JCN	NA	
AREA	7	
COUNTY	SONOMA	
SCALE	1"=40'	
SHEET NO.	1	OF 16
DRAWING NUMBER	L-10193	CHANGE
		2

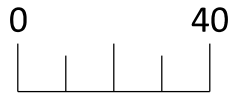

SCALE: 1"=40'



LEGEND

- ED — UNDERGROUND ELECTRICAL LINE
- GT — GAS PIPELINE
- TSP
- STORM DRAIN INLET
- T — TELEPHONE
- W — WATER LINE
- SS — SANITARY SEWER
- SD — STORM DRAIN
- EXISTING POLE
- ← GUY WIRE

**DETAIL A
NOT TO SCALE**

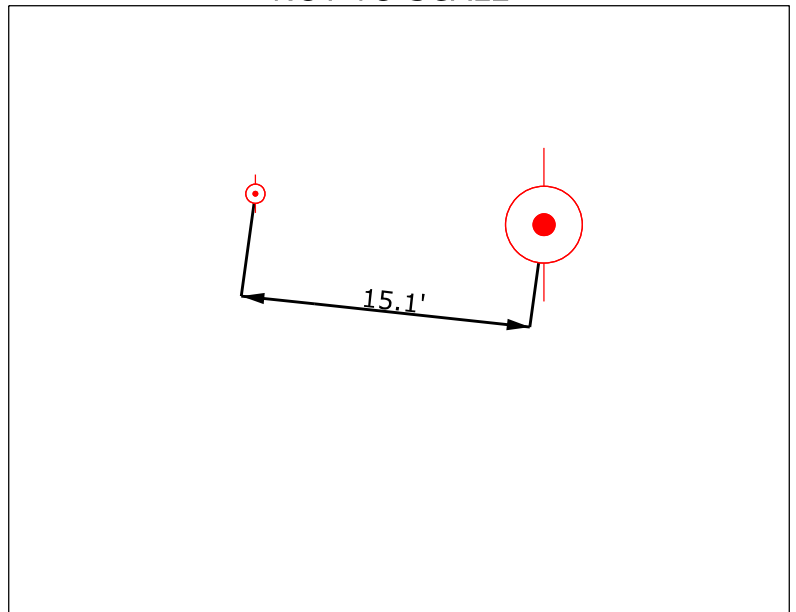

AUTHORIZATION	
74000600	
BY	F3
DR	J82I
CH	WDCF
O.K.	PXGE
DATE	JAN 2019

FULTON-FITCH
TOWER PROJECT NUMBER 22

PACIFIC GAS AND ELECTRIC COMPANY
San Francisco California



JCN	NA	
AREA	7	
COUNTY	SONOMA	
SCALE	1"=40'	
SHEET NO.	2	OF 16
DRAWING NUMBER	L-10193	CHANGE
		2

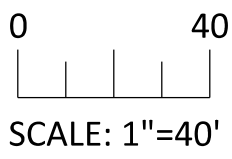
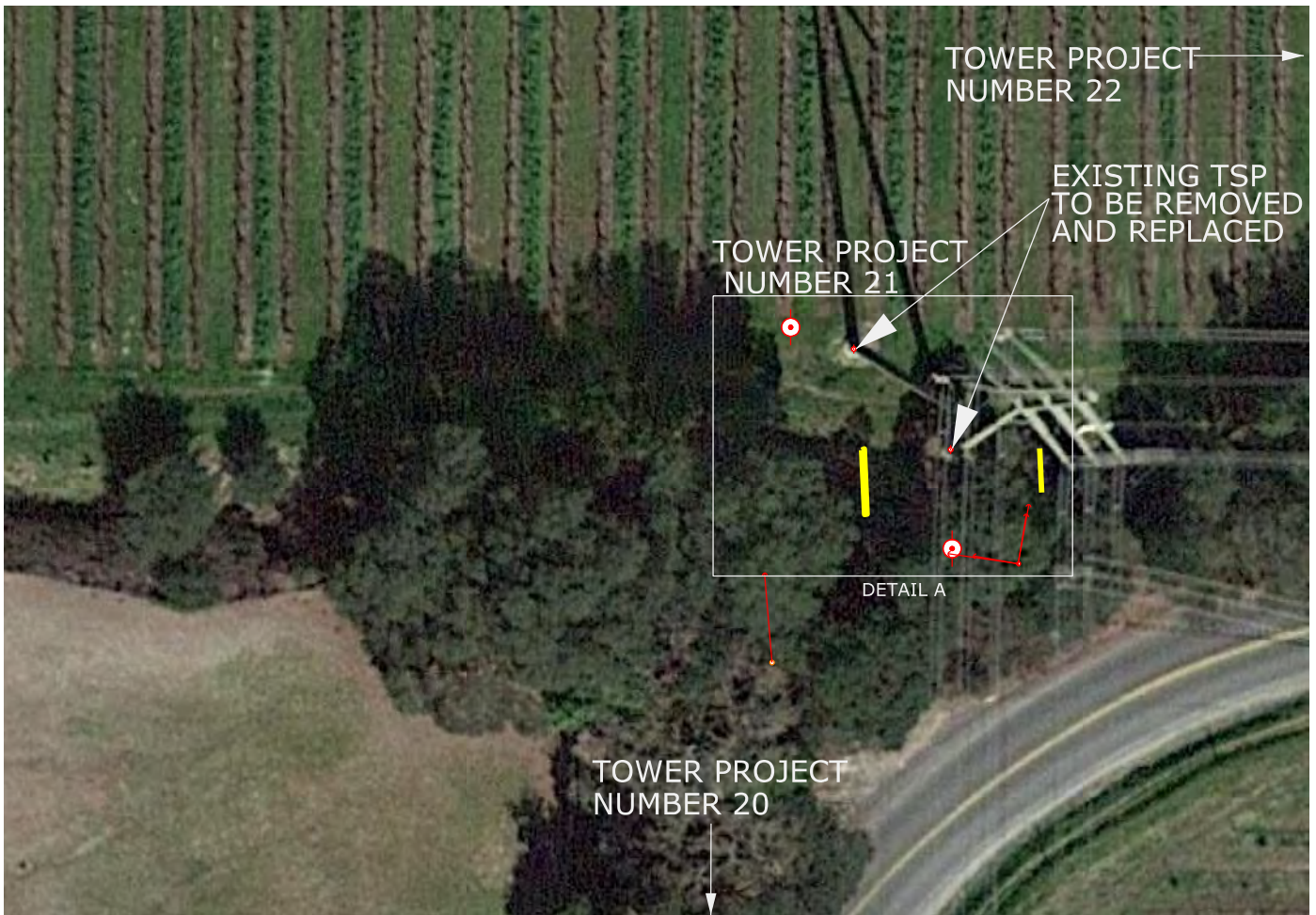

LEGEND

- ED — UNDERGROUND ELECTRICAL LINE
- GT — GAS PIPELINE
- ⊙ TSP
- ⊙ SD STORM DRAIN INLET
- T — TELEPHONE
- W — WATER LINE
- SS — SANITARY SEWER
- SD — STORM DRAIN
- EXISTING POLE
- ← GUY WIRE

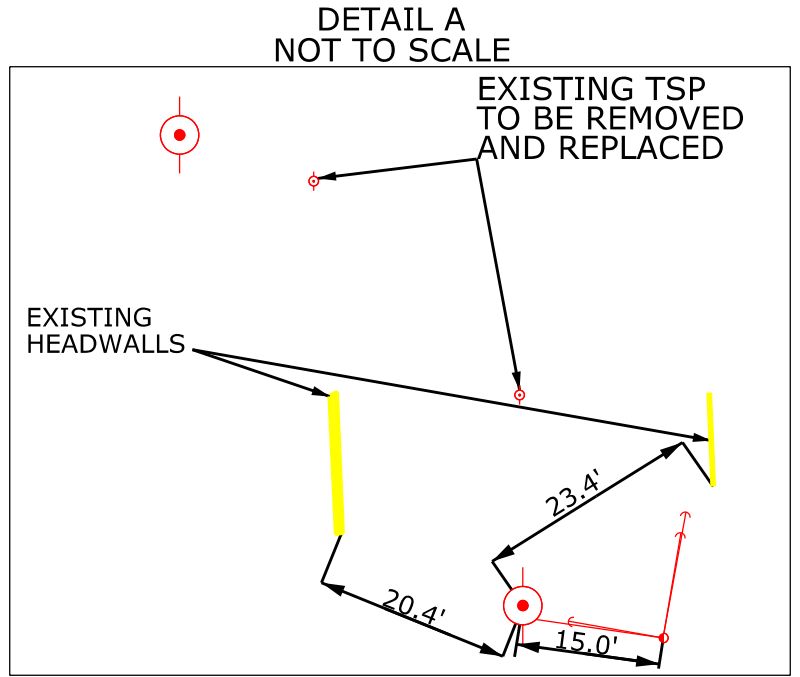

AUTHORIZATION 74000600	
BY	F3
DR	J82I
CH	WDCF
O.K.	PXGE
DATE	JAN 2019

FULTON-FITCH
TOWER PROJECT NUMBER 21

PACIFIC GAS AND ELECTRIC COMPANY
San Francisco California



JCN	NA	
AREA	7	
COUNTY	SONOMA	
SCALE	1"=40'	
SHEET NO.	3	OF 16
DRAWING NUMBER	L-10193	
CHANGE	2	

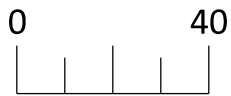

SCALE: 1"=40'



LEGEND

- ED — UNDERGROUND ELECTRICAL LINE
- GT — GAS PIPELINE
- TSP
- STORM DRAIN INLET
- T — TELEPHONE
- W — WATER LINE
- SS — SANITARY SEWER
- SD — STORM DRAIN
- STORM DRAIN MANHOLE
- ELECTROLIER POLE

DETAIL A
NOT TO SCALE

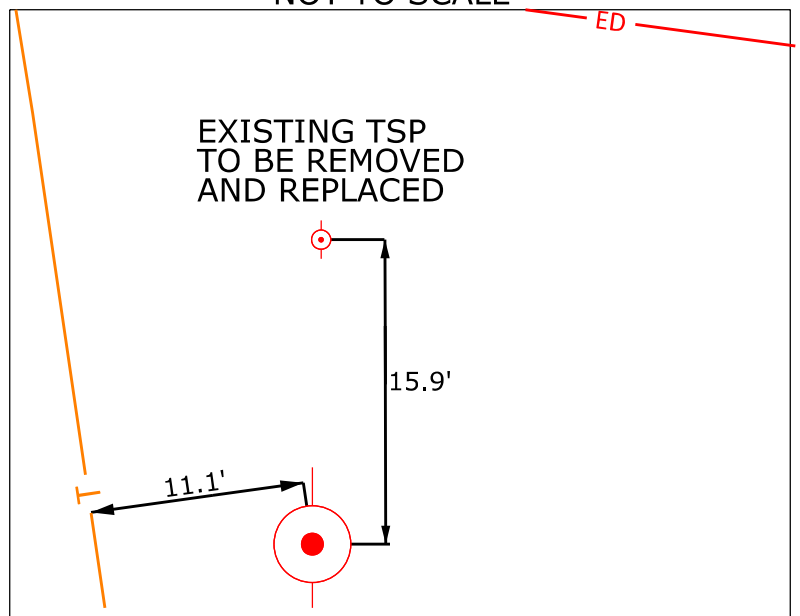

AUTHORIZATION 74000600	
BY	F3
DR	J82I
CH	WDCF
O.K.	PXGE
DATE	JAN 2019

FULTON-FITCH

TOWER PROJECT NUMBER 20



PACIFIC GAS AND ELECTRIC COMPANY
San Francisco California

JCN	NA	
AREA	7	
COUNTY	SONOMA	
SCALE	1"=40'	
SHEET NO.	4	OF 16
DRAWING NUMBER	L-10193	CHANGE 2

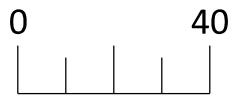

SCALE: 1"=40'



LEGEND

- ED — UNDERGROUND ELECTRICAL LINE
- GT — GAS PIPELINE
- ⊙ TSP
- SD STORM DRAIN INLET
- T — TELEPHONE
- W — WATER LINE
- SS — SANITARY SEWER
- SD — STORM DRAIN
- ⊕ STORM DRAIN MANHOLE
- ⊙ ELECTROLIER POLE

DETAIL A
NOT TO SCALE

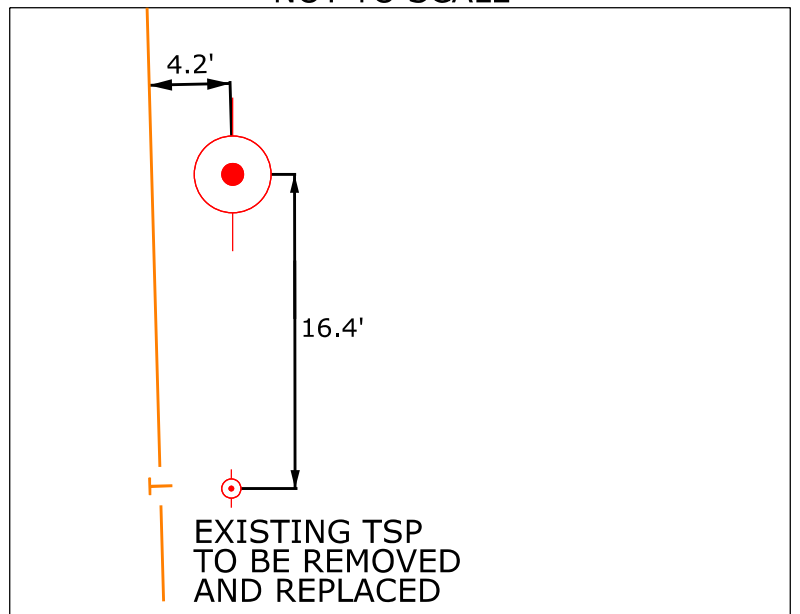

AUTHORIZATION 74000600	
BY	F3
DR	J82I
CH	WDCF
O.K.	PXGE
DATE	JAN 2019

FULTON-FITCH

TOWER PROJECT NUMBER 19

PACIFIC GAS AND ELECTRIC COMPANY
San Francisco California



JCN	NA	
AREA	7	
COUNTY	SONOMA	
SCALE	1"=40'	
SHEET NO.	5	OF 16
DRAWING NUMBER	L-10193	CHANGE 2

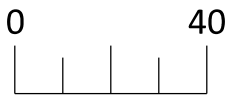

SCALE: 1"=40'



LEGEND

- ED — UNDERGROUND ELECTRICAL LINE
- GT — GAS PIPELINE
- TSP
- STORM DRAIN INLET
- UNK — UNKNOWN UNDERGROUND UTILITY
- W — WATER LINE
- SS — SANITARY SEWER
- SD — STORM DRAIN
- STORM DRAIN MANHOLE
- ELECTROLIER POLE

**DETAIL A
NOT TO SCALE**

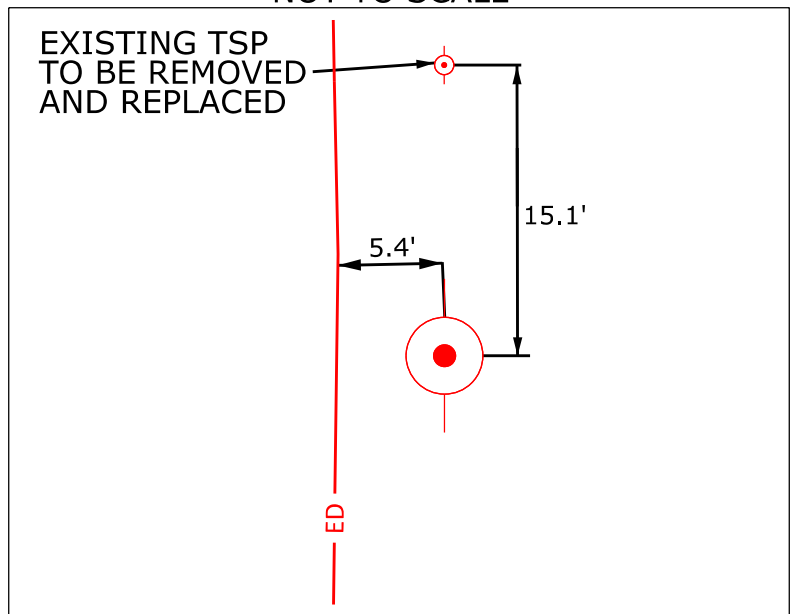

AUTHORIZATION 74000600	
BY	F3
DR	J82I
CH	WDCF
O.K.	PXGE
DATE	JAN 2019

FULTON-FITCH

TOWER PROJECT NUMBER 18



PACIFIC GAS AND ELECTRIC COMPANY
San Francisco California

JCN	NA	
AREA	7	
COUNTY	SONOMA	
SCALE	1"=40'	
SHEET NO.	6	OF 16
DRAWING NUMBER	L-10193	CHANGE
		2

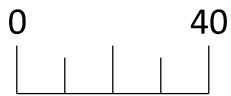

SCALE: 1"=40'



LEGEND

- ED — UNDERGROUND ELECTRICAL LINE
- GT — GAS PIPELINE
- ⊙ TSP
- SD STORM DRAIN INLET
- C — COMMUNICATIONS UNDERGROUND
- W — WATER LINE
- SS — SANITARY SEWER
- SD — STORM DRAIN
- ⊕ STORM DRAIN MANHOLE
- ⊙ ELECTROLIER POLE

DETAIL A
NOT TO SCALE

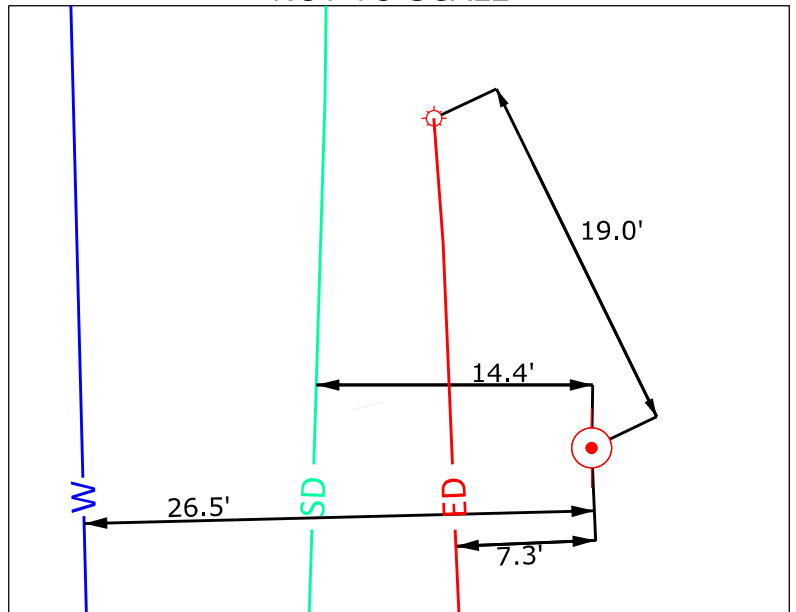

AUTHORIZATION 74000600	
BY	F3
DR	J82I
CH	WDCF
O.K.	PXGE
DATE	JAN 2019

FULTON-FITCH

TOWER PROJECT NUMBER 17



PACIFIC GAS AND ELECTRIC COMPANY
San Francisco California

JCN	NA	
AREA	7	
COUNTY	SONOMA	
SCALE	1"=40'	
SHEET NO.	7	OF 16
DRAWING NUMBER	L-10193	CHANGE
		2

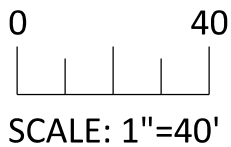

LEGEND

- ED — UNDERGROUND ELECTRICAL LINE
- GT — GAS PIPELINE
- ⊙ TSP
- ⊙ SD — STORM DRAIN
- SD — STORM DRAIN LINE
- SS — SANITARY SEWER
- EXISTING POLE

AUTHORIZATION 74000600	
BY	F3
DR	J82I
CH	WDCF
O.K.	PXGE
DATE	JAN 2019

FULTON-FITCH
TOWER PROJECT NUMBER 16

PACIFIC GAS AND ELECTRIC COMPANY
San Francisco California



JCN	NA	
AREA	7	
COUNTY	SONOMA	
SCALE	1"=40'	
SHEET NO.	8	OF 16
DRAWING NUMBER	L-10193	CHANGE 2

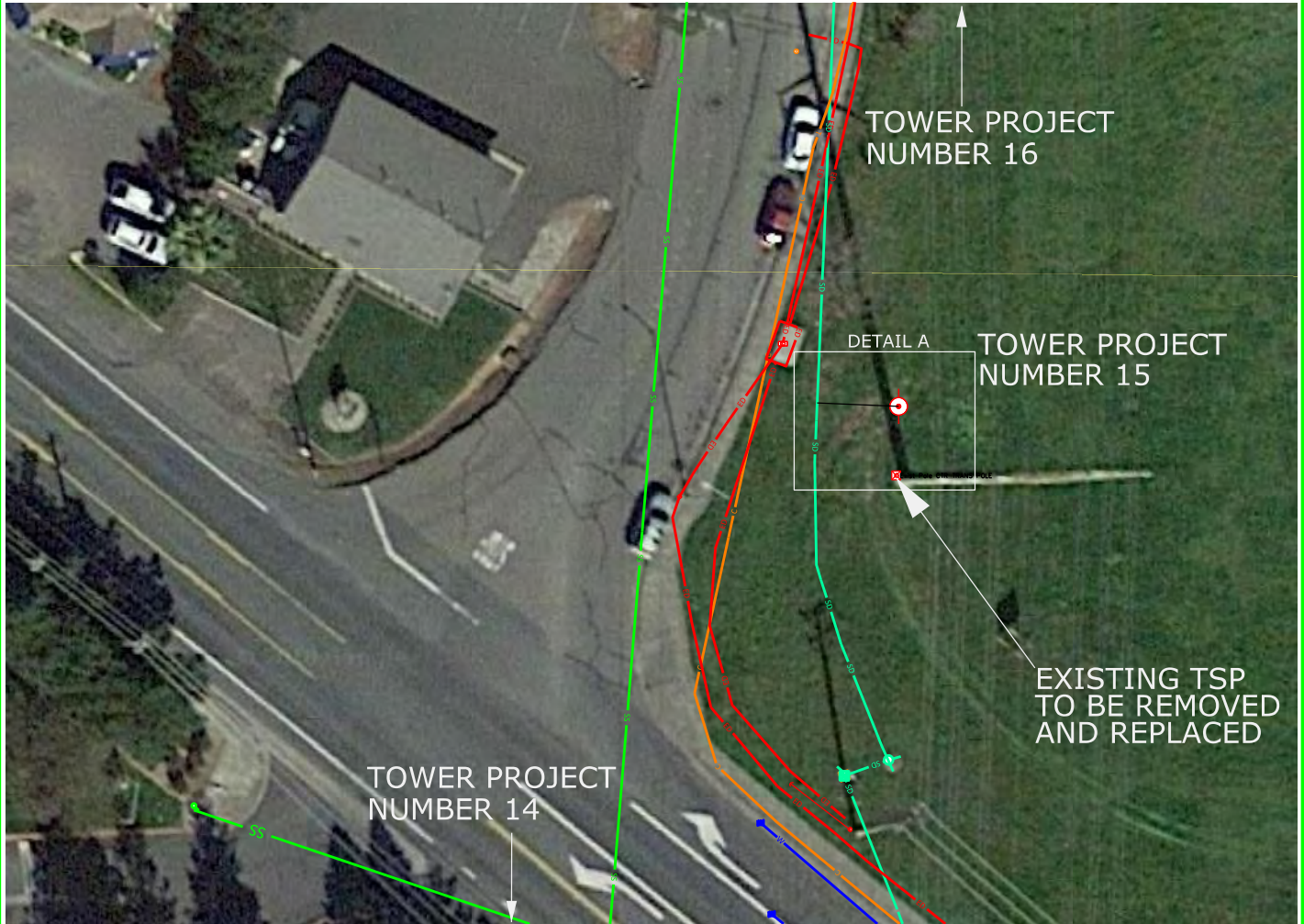

DETAIL A
NOT TO SCALE

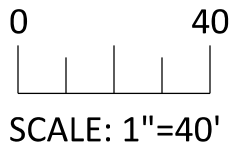

LEGEND

- ED — UNDERGROUND ELECTRICAL LINE
- GT — GAS PIPELINE
- TSP
- SD — STORM DRAIN
- T — TELEPHONE
- W — WATER LINE
- SS — SANITARY SEWER

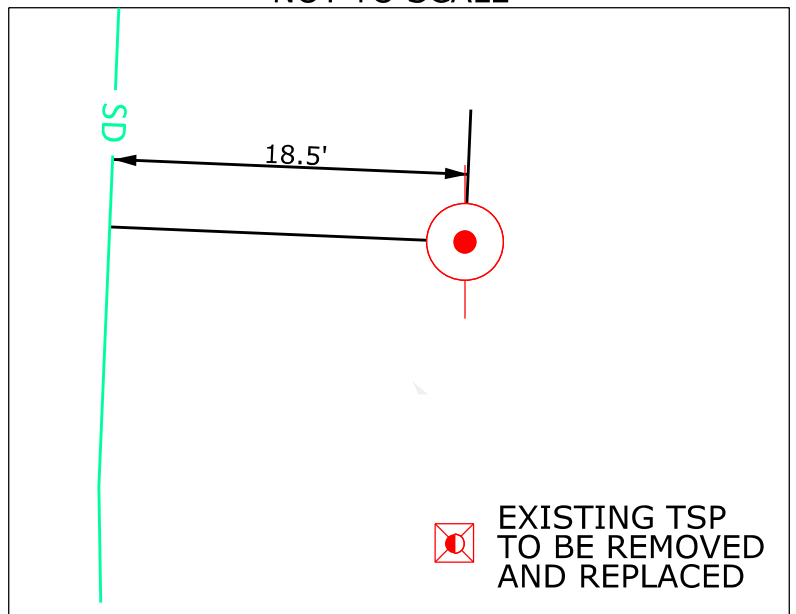

EXISTING TSP TO BE REMOVED AND REPLACED

AUTHORIZATION	
74000600	
BY	F3
DR	J82I
CH	WDCF
O.K.	PXGE
DATE	JAN 2019

FULTON-FITCH

TOWER PROJECT NUMBER 15

PACIFIC GAS AND ELECTRIC COMPANY
San Francisco California

JCN	NA	
AREA	7	
COUNTY	SONOMA	
SCALE	1"=40'	
SHEET NO.	9	OF 16
DRAWING NUMBER	L-10193	CHANGE
		2

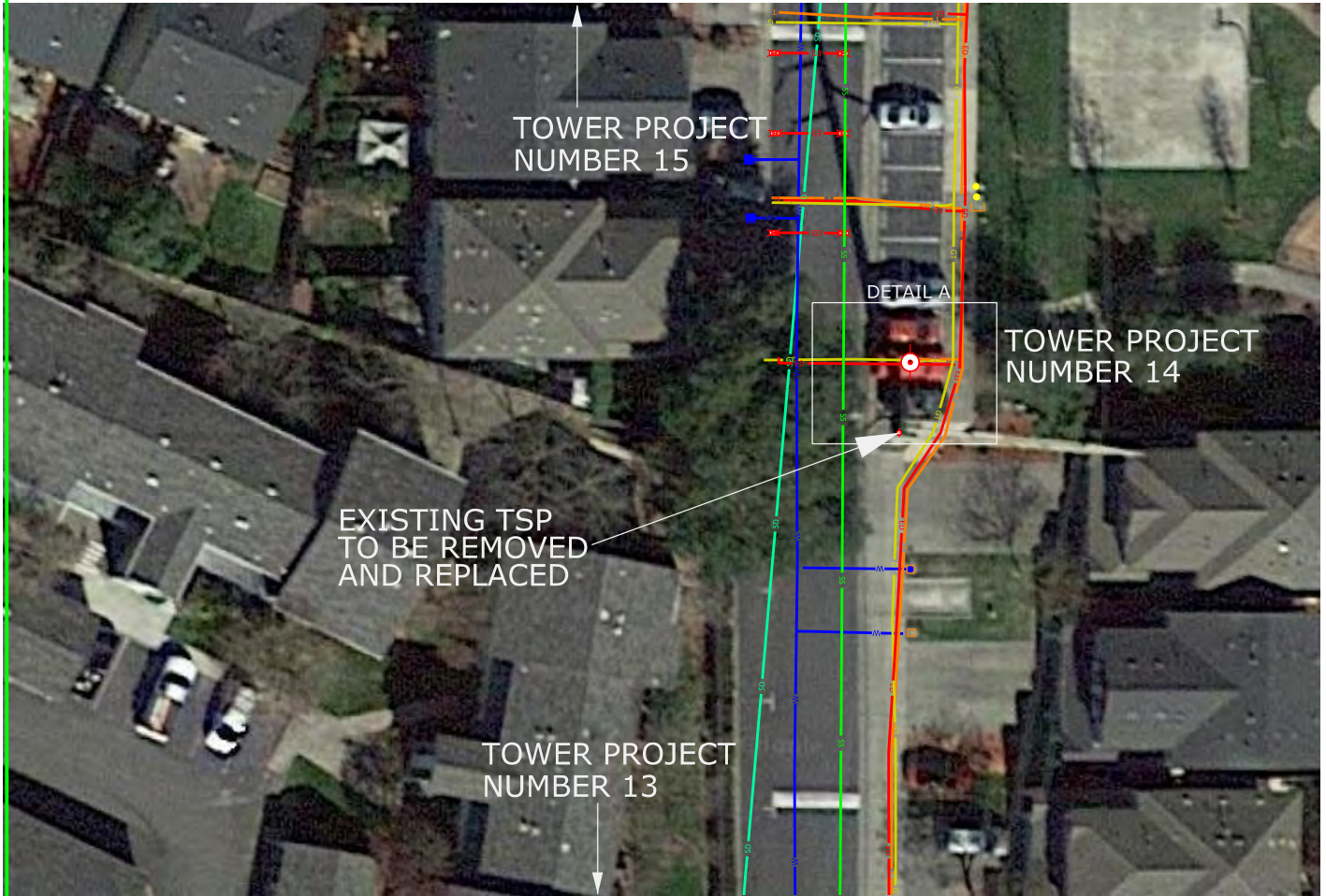

DETAIL A
NOT TO SCALE

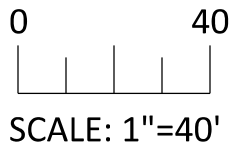

LEGEND

- ED — UNDERGROUND ELECTRICAL LINE
- GT — GAS PIPELINE
- TSP
- STORM DRAIN
- T — TELEPHONE
- W — WATER LINE
- SS — SANITARY SEWER

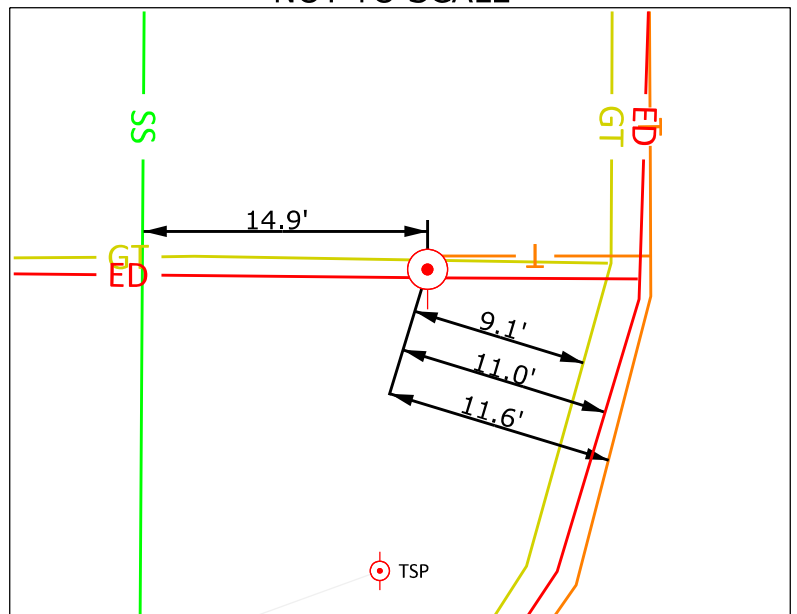

AUTHORIZATION 74000600	
BY	F3
DR	J82I
CH	WDCF
O.K.	PXGE
DATE	JAN 2019

FULTON-FITCH

TOWER PROJECT NUMBER 14



PACIFIC GAS AND ELECTRIC COMPANY
San Francisco California

JCN	NA	
AREA	7	
COUNTY	SONOMA	
SCALE	1"=40'	
SHEET NO.	10	OF 16
DRAWING NUMBER	L-10193	
CHANGE	2	

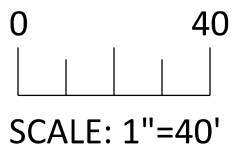

LEGEND

- ED — UNDERGROUND ELECTRICAL LINE
- GT — GAS PIPELINE
- TSP
- STORM DRAIN
- UNK — UNKNOWN UNDERGROUND UTILITY

DETAIL A
NOT TO SCALE

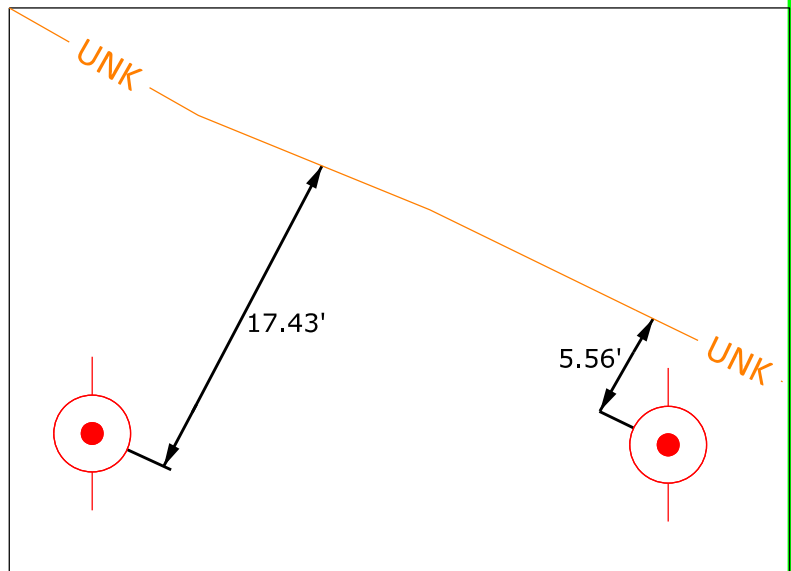

AUTHORIZATION 74000600	
BY	F3
DR	J82I
CH	WDCF
O.K.	PXGE
DATE	JAN 2019

FULTON-FITCH
TOWER PROJECT NUMBER 13



PACIFIC GAS AND ELECTRIC COMPANY
San Francisco California

JCN	NA	
AREA	7	
COUNTY	SONOMA	
SCALE	1"=40'	
SHEET NO.	11	OF 16
DRAWING NUMBER	L-10193	CHANGE
		2

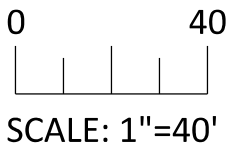

LEGEND

- ED — UNDERGROUND ELECTRICAL LINE
- GT — GAS PIPELINE
- TSP
- STORM DRAIN
- SD — STORM DRAIN LINE

AUTHORIZATION 74000600	
BY	F3
DR	J82I
CH	WDCF
O.K.	PXGE
DATE	JAN 2019

FULTON-FITCH

TOWER PROJECT NUMBER 12

PACIFIC GAS AND ELECTRIC COMPANY
San Francisco California

JCN	NA	
AREA	7	
COUNTY	SONOMA	
SCALE	1"=40'	
SHEET NO.	12	OF 16
DRAWING NUMBER	L-10193	CHANGE 2

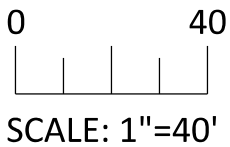

LEGEND

- ED — UNDERGROUND ELECTRICAL LINE
- GT — GAS PIPELINE
- TSP
- SD STORM DRAIN
- SD — STORM DRAIN LINE

AUTHORIZATION 74000600	
BY	F3
DR	J82I
CH	WDCF
O.K.	PXGE
DATE	JAN 2019

FULTON-FITCH

TOWER PROJECT NUMBER 11



PACIFIC GAS AND ELECTRIC COMPANY
San Francisco California

JCN	NA	
AREA	7	
COUNTY	SONOMA	
SCALE	1"=40'	
SHEET NO.	13	OF 16
DRAWING NUMBER	L-10193	CHANGE
		2

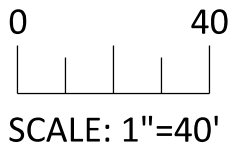

LEGEND

- ED — UNDERGROUND ELECTRICAL LINE
- GT — GAS PIPELINE
- ⊙ TSP
- ⊙ SD STORM DRAIN
- W — WATER LINE

DETAIL A

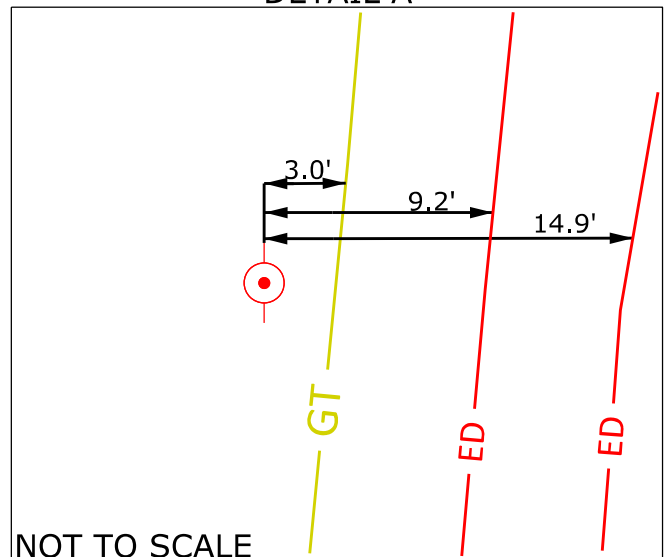

AUTHORIZATION 74000600	
BY	F3
DR	J82I
CH	WDCF
O.K.	PXGE
DATE	JAN 2019

FULTON-FITCH
TOWER PROJECT NUMBER 10

PACIFIC GAS AND ELECTRIC COMPANY
San Francisco California



JCN	NA	
AREA	7	
COUNTY	SONOMA	
SCALE	1"=40'	
SHEET NO.	14	OF 16
DRAWING NUMBER	L-10193	CHANGE 2

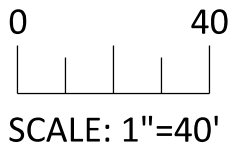

LEGEND

- ED — UNDERGROUND ELECTRICAL LINE
- GT — GAS PIPELINE
- TSP
- STORM DRAIN

DETAIL A

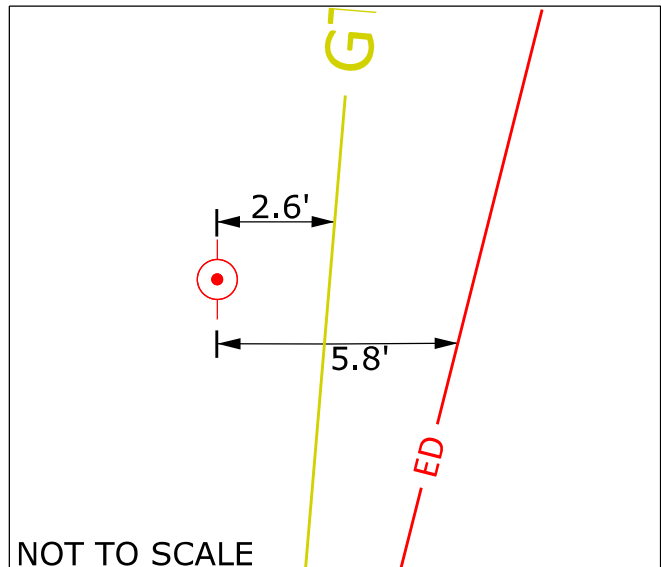

AUTHORIZATION 74000600	
BY	F3
DR	J82I
CH	WDCF
O.K.	PXGE
DATE	JAN 2019

FULTON-FITCH

TOWER PROJECT NUMBER 9

PACIFIC GAS AND ELECTRIC COMPANY
San Francisco California

JCN	NA	
AREA	7	
COUNTY	SONOMA	
SCALE	1"=40'	
SHEET NO.	15	OF 16
DRAWING NUMBER	L-10193	CHANGE
		2

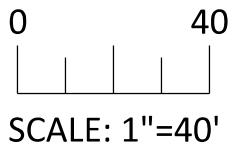
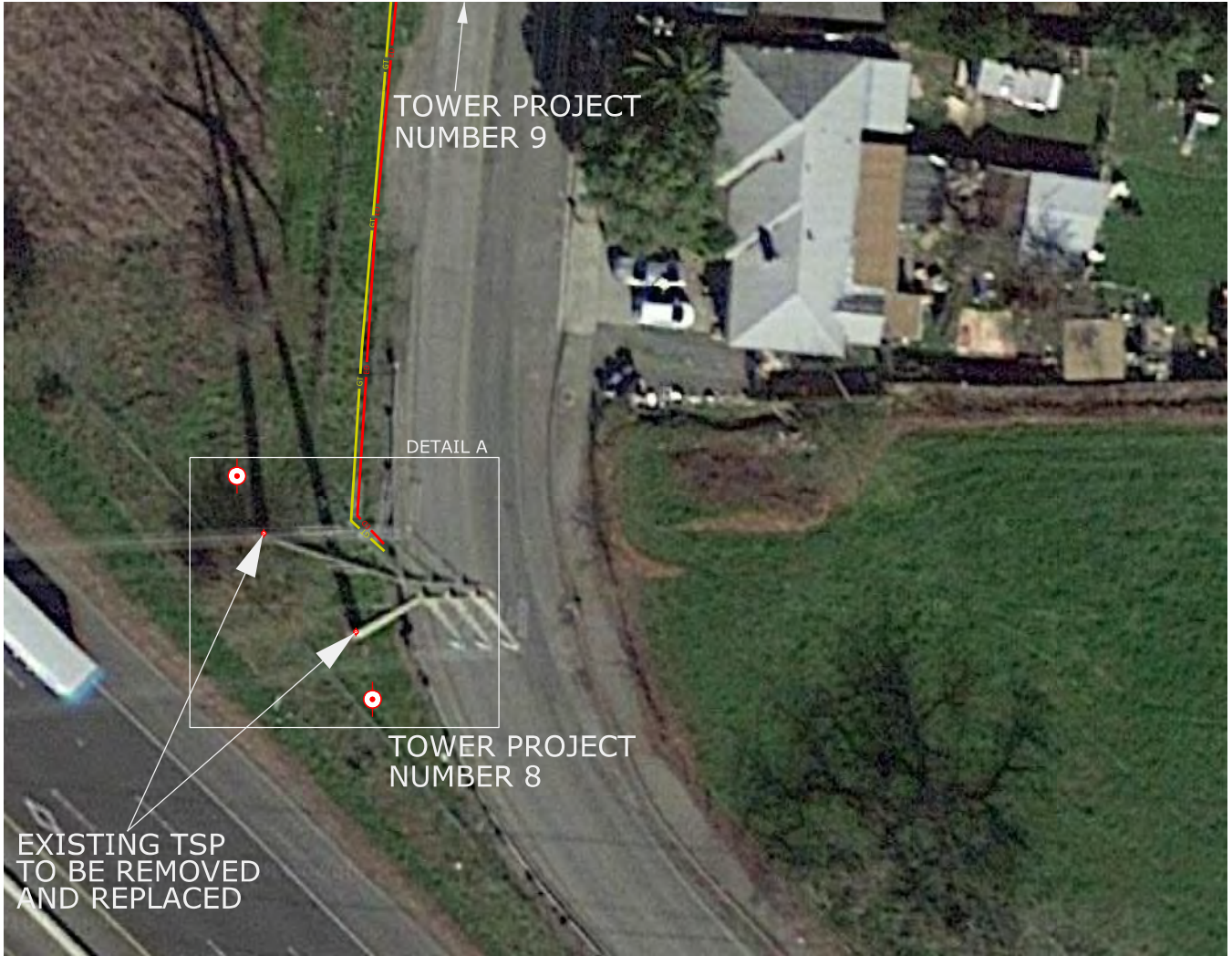

DETAIL A
NOT TO SCALE

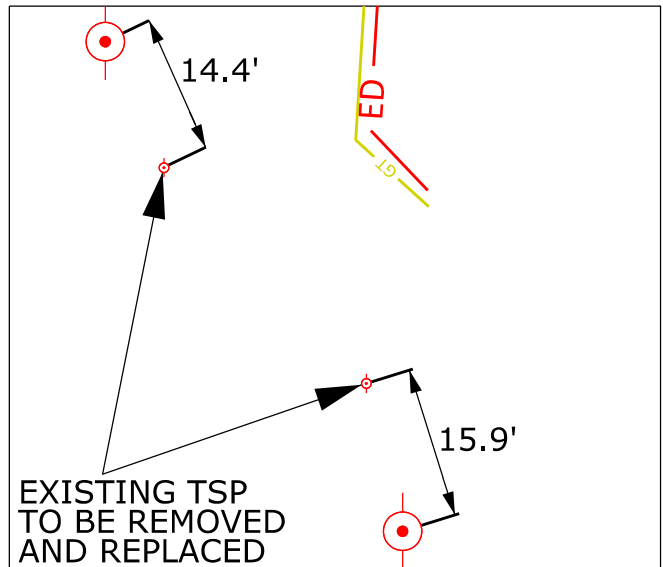

LEGEND

- ED — UNDERGROUND ELECTRICAL LINE
- GT — GAS PIPELINE
- TSP
- SD STORM DRAIN

AUTHORIZATION 74000600	
BY	F3
DR	J82I
CH	WDCF
O.K.	PXGE
DATE	JAN 2019

FULTON-FITCH

TOWER PROJECT NUMBER 8

PACIFIC GAS AND ELECTRIC COMPANY
San Francisco California

JCN	NA	
AREA	7	
COUNTY	SONOMA	
SCALE	1"=40'	
SHEET NO.	16	OF 16
DRAWING NUMBER	L-10193	CHANGE 1