

RECEIVED
JAN 24 2018
CALTRANS

SIGN LEGEND

TABLE 1

SPEED (S)	TAPER LENGTH CRITERIA AND CHANNELIZING DEVICE SPACING							
	MINIMUM TAPER LENGTH * FOR WIDTH OF OFFSET 12 FEET (W)				MAXIMUM CHANNELIZING DEVICE SPACING			
	TANGENT 2L	MERGING L	SHIFTING L/2	SHOULDER L/3	TAPER	TANGENT	CONFLICT	
20	160	80	40	27	20	40	10	
25	250	125	63	42	25	50	12	
30	360	180	90	60	30	60	15	
35	490	245	123	82	35	70	17	
40	640	320	160	107	40	80	20	
45	1080	540	270	180	45	90	22	
50	1200	600	300	200	50	100	25	
55	1320	660	330	220	50	100	25	
60	1440	720	360	240	50	100	25	
65	1560	780	390	260	50	100	25	
70	1680	840	420	280	50	100	25	
75	1800	900	450	300	50	100	25	

* - For other offsets, use the following merging taper length formula for L:
For speed of 40 mph or less, L = WSA/60
For speed of 45 mph or more L = WS
Where: L = Taper length in feet
W = Width of offset in feet
S = Posted speed limit, off-peak 85th-percentile speed prior to work starting or the anticipated operating speed in mph

TABLE 2

SPEED *	Min D **	LONGITUDINAL BUFFER SPACE AND FLAGGER STATION SPACING		
		DOWNGRADE Min D ***		
		-3%	-6%	-9%
20	115	116	120	126
25	155	158	165	173
30	200	205	215	227
35	250	257	271	287
40	305	315	333	354
45	360	378	400	427
50	425	446	474	507
55	495	520	553	593
60	570	598	638	686
65	645	682	728	785
70	730	771	825	891
75	820	866	927	1003

* - Speed is posted speed limit, off-peak 85th-percentile speed prior to work starting, or the anticipated operating speed in mph
** - Longitudinal buffer space or flagger station spacing
*** - Use on sustained downgrade steeper than -3 percent and longer than 1 mile

TABLE 3

ROAD TYPE	ADVANCE WARNING SIGN SPACING		
	DISTANCE BETWEEN SIGNS *		
	A	B	C
URBAN - 25 mph OR LESS	100	100	100
URBAN - MORE THAN 25 mph TO 40 mph	250	250	250
URBAN - MORE THAN 40 mph	350	350	350
RURAL	500	500	500
EXPRESSWAY / FREEWAY	1000	500	2640

* - The distances are approximate, are intended for guidance purposes only, and should be applied with engineering judgment. These distances should be adjusted by the Engineer for field conditions, if necessary, by increasing or decreasing the recommended distances.

LEGEND

- APPROXIMATE TRENCH LOCATION
- SIGN
- TRAFFIC CONES / DELINEATOR
- BARRICADE
- FLAGGER
- FLASHING ARROW SIGN
- WORK ZONE
- ZONEGUARD
- SIGN WITH PORTABLE FLASHING BEACON
- QUADGUARD II CRASH CUSHION
- CALTRANS CRASH ARRAY TU17

APPROVED ENCLOSURE
11-17-0617-0463
JAN 29 2018

PROJECT NAME: TL23071 - Sycamore Canyon Substation To Penasquitos Substation - 230 KV Underground

AIRX SURVEYORS, INC.
Gail McMorran
President
254 EAST EL NORTE PARKWAY SUITE C
ESCONDIDO, CA 92027
PHONE (760) 480-2347
CELL (760) 419-3738

NV5
15092 AVENUE OF SCIENCE, SUITE 200
SAN DIEGO, CA 92128
P: 858 385.0500 WWW.NV5.COM

AIRX JOB#: X160218
MISC/POTHOLE#:
TYPE OF WORK: TRENCHING / CONDUIT

THOMAS GRID#: 1209-F6
DRAWN FOR: CALTRANS



DATE: 1/22/2018
DESIGNED: Clint Jones
CHECKED BY: Mark Webb

SHEET 1 OF 48

PHASE MAP: (NOT TO SCALE)

RECEIVED
JAN 24 2018
CALTRANS-PER...

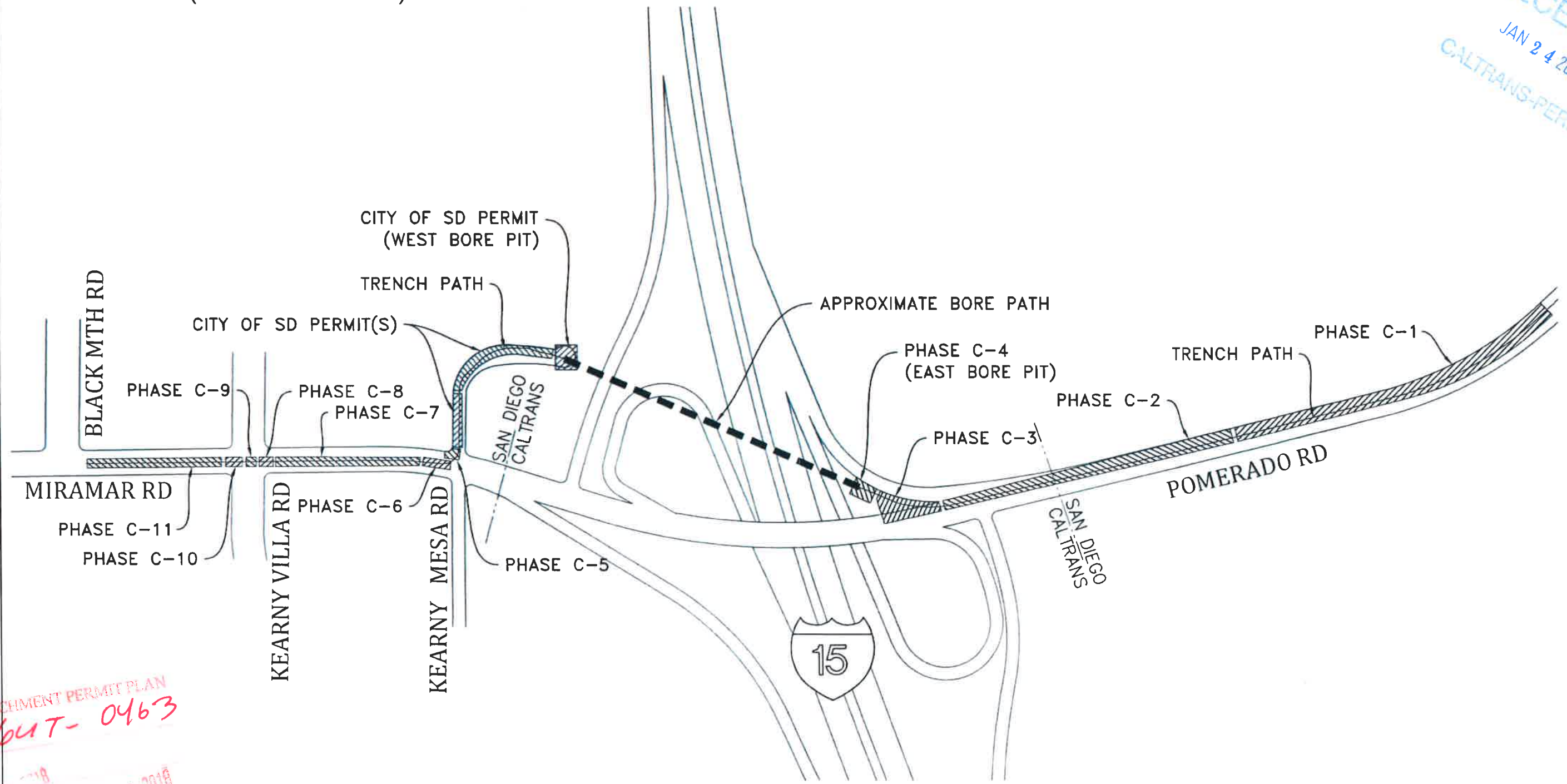

APPROVED ENCROACHMENT PERMIT PLAN
11-17-647-0463
JAN 29 2018

PROJECT NAME: TL23071 - Sycamore Canyon Substation To
Penasquitos Substation - 230 KV Underground

UTILITY SURVEYORS, INC
AIRX
Gail McMorran
President
2534 EAST EL NORTE PARKWAY SUITE C
ESCONDIDO, CA 92027
PHONE (760) 480-2347
CELL (760) 419-3738

NV5
15092 AVENUE OF SCIENCE, SUITE 200
SAN DIEGO, CA 92128
P: 858 385 0500 WWW.NV5.COM

AIRX JOB#: X160218

MISC/POTHOLE#:

TYPE OF WORK: TRENCHING / CONDUIT

THOMAS GRID#: 1209-F6

DRAWN FOR: CALTRANS



DATE: 1/22/2018
DESIGNED: Clint Jones
CHECKED BY: Mark Webb

SHEET 2 OF 48

RECEIVED
JAN 24 2018
CALTRANS-PERMIT

REMOVE & REPLACE EXISTING GLUE-DOWN CHANNELIZERS
PER SEPARATE CITY OF SAN DIEGO PERMIT

APPROXIMATE
TRENCH LOCATION

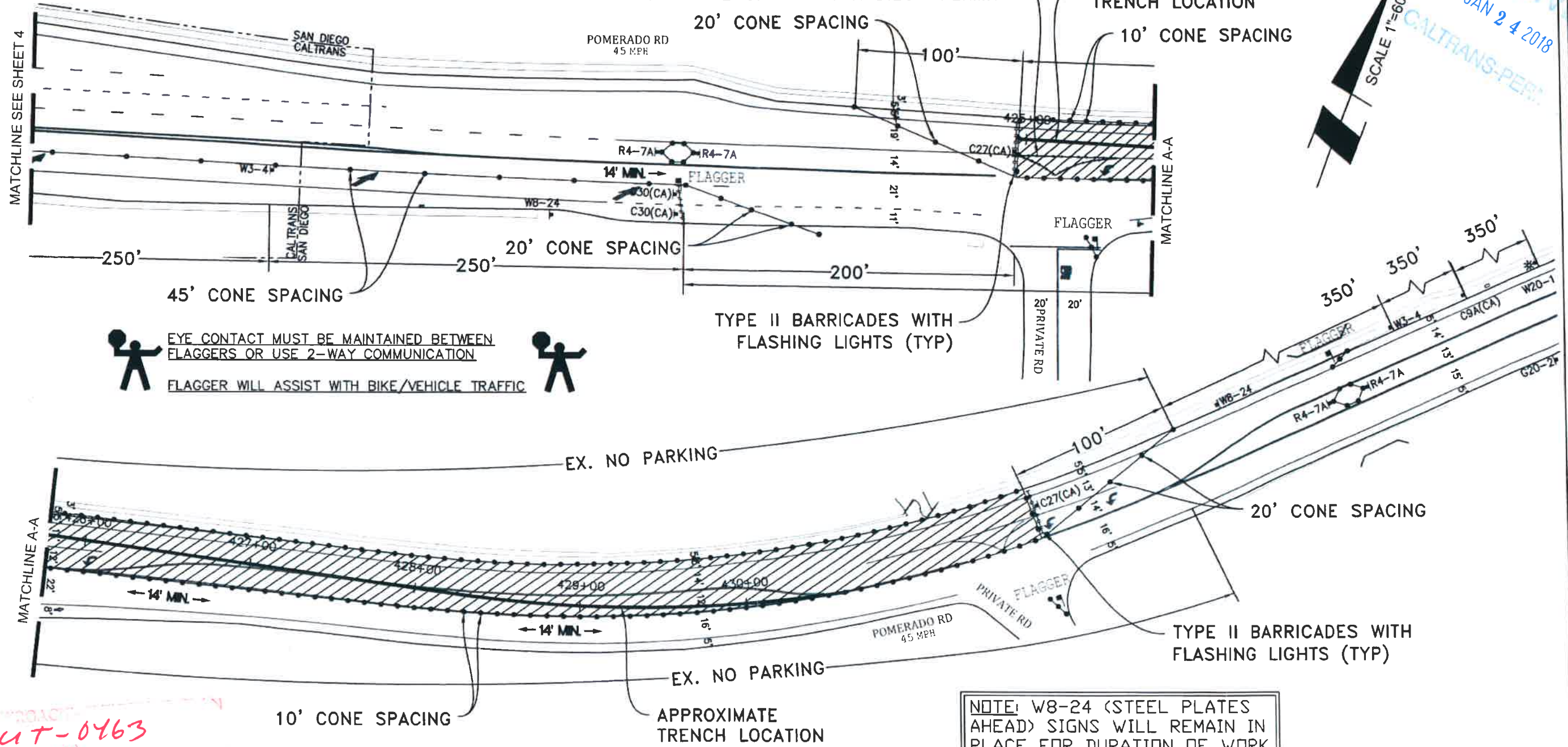

EYE CONTACT MUST BE MAINTAINED BETWEEN
FLAGGERS OR USE 2-WAY COMMUNICATION
FLAGGER WILL ASSIST WITH BIKE/VEHICLE TRAFFIC

NOTE: W8-24 (STEEL PLATES
AHEAD) SIGNS WILL REMAIN IN
PLACE FOR DURATION OF WORK

PHASE C - 1

APPROVED PROJECT
11-17-647-0463
Permit No.

Date: (JAN 29 2018)

PROJECT NAME: TL23071 - Sycamore Canyon Substation To
Penasquitos Substation - 230 KV Underground

DATE: 1/22/2018
DESIGNED: Clint Jones
CHECKED BY: Mark Webb

UTILITY SURVEYORS, INC.
AIRX
Gail McMorran
President
2534 EAST FL NORTE PARKWAY SUITE C
ESCONDIDO, CA 92027
PHONE: (760) 480-2347
CELL: (760) 419-3738

NV5
15092 AVENUE OF SCIENCE, SUITE 200
SAN DIEGO, CA 92128
P: 858 385 0500 WWW.NV5.COM



AIRX JOB#: X160218
MISC/POTHOLE#:
TYPE OF WORK: TRENCHING / CONDUIT

THOMAS GRID#: 1209-F6
DRAWN FOR: CALTRANS

REGISTERED PROFESSIONAL ENGINEER
MARK H. WEBB
No. 46328
CIVIL
STATE OF CALIFORNIA

SHEET 3 OF 48

RECEIVED
 JAN 24 2018
 CALTRANS-PERMIT

 EYE CONTACT MUST BE MAINTAINED BETWEEN FLAGGERS OR USE 2-WAY COMMUNICATION
FLAGGER WILL ASSIST WITH BIKE/VEHICLE TRAFFIC 

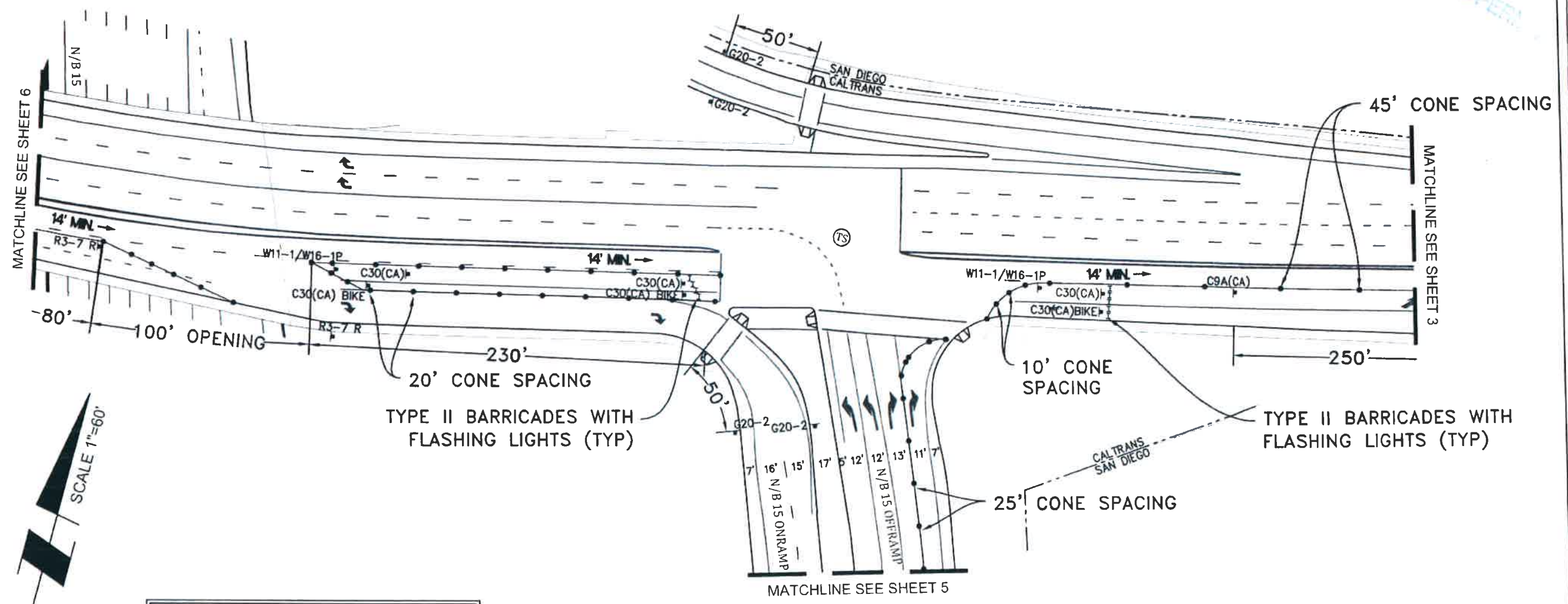

NOTE: W8-24 (STEEL PLATES AHEAD) SIGNS WILL REMAIN IN PLACE FOR DURATION OF WORK

APPROVED ENCROACHMENT PERMIT PL
 11-17-64T-0463
 Permit No.:
 Date: JAN 24 2018

PHASE C - 1

PROJECT NAME: TL23071 - Sycamore Canyon Substation To Penasquitos Substation - 230 KV Underground

DATE: 1/22/2018
 DESIGNED: Clint Jones
 CHECKED BY: Mark Webb

UTILITY SURVEYORS, INC.
AIRX
 Gail McMorrin
 President
 2534 EAST EL NORTE PARKWAY SUITE C
 ESCONDIDO, CA 92027
 PHONE (760) 480-2347
 CELL (760) 419-3738

NV5
 15092 AVENUE OF SCIENCE, SUITE 200
 SAN DIEGO, CA 92128
 P: 858 385 0500 WWW.NV5.COM

AIRX JOB#: X160218
 THOMAS GRID#: 1209-F6
 MISC/POTHOLE#: DRAWN FOR: CALTRANS
 TYPE OF WORK: TRENCHING / CONDUIT



SHEET 4 OF 48

RECEIVED
 JAN 24 2018
 CALTRANS-PER

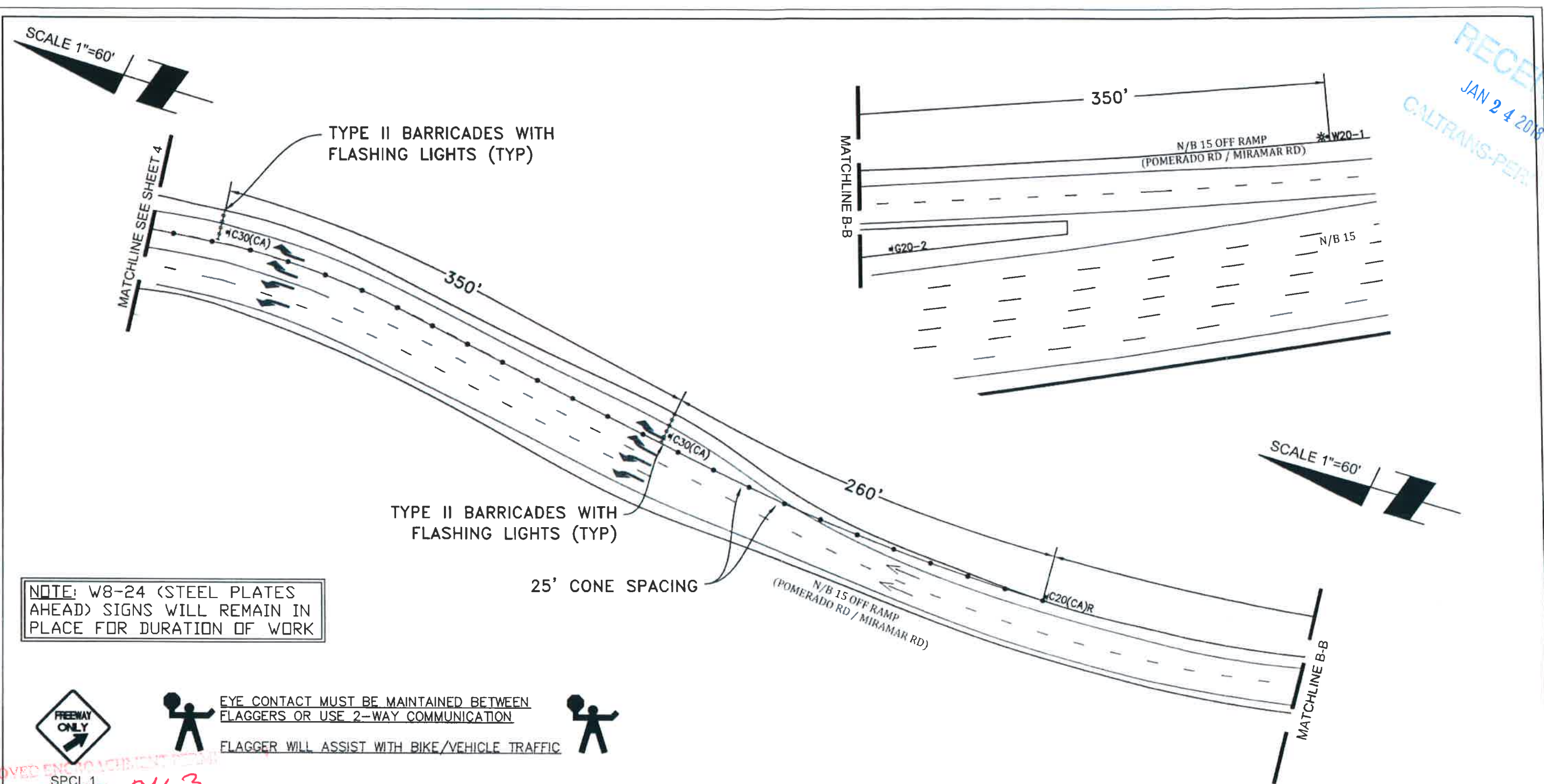

NOTE: W8-24 (STEEL PLATES AHEAD) SIGNS WILL REMAIN IN PLACE FOR DURATION OF WORK



EYE CONTACT MUST BE MAINTAINED BETWEEN FLAGGERS OR USE 2-WAY COMMUNICATION
 FLAGGER WILL ASSIST WITH BIKE/VEHICLE TRAFFIC



APPROVED ENCLOSURE PERMIT
 11-17-6ut-0163
 Permit No.

PHASE C - 1

PROJECT NAME: TL23071 - Sycamore Canyon Substation To Penasquitos Substation - 230 KV Underground

DATE: 1/22/2018
 DESIGNED: Clint Jones
 CHECKED BY: Mark Webb

UTILITY SURVEYORS, INC.
AIRX
 Gail McMorran
 President
 2534 EAST EL NORTE PARKWAY SUITE C
 ESCONDIDO, CA 92027
 PHONE: (760) 480-2347
 CELL: (760) 419-3738

NV5
 15092 AVENUE OF SCIENCE, SUITE 200
 SAN DIEGO, CA 92128
 P: 858 385 0500 WWW.NV5.COM

AIRX JOB#: X160218
 THOMAS GRID#: 1209-F6
 MISC/POTHOLE#:
 TYPE OF WORK: TRENCHING / CONDUIT

DRAWN FOR: CALTRANS



SHEET 5 OF 48

JAN 29 2018

RECEIVED
 JAN 24 2018
 CALTRANS-PER

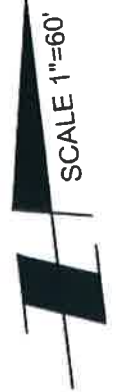

NOTE: W8-24 (STEEL PLATES AHEAD) SIGNS WILL REMAIN IN PLACE FOR DURATION OF WORK

EYE CONTACT MUST BE MAINTAINED BETWEEN FLAGGERS OR USE 2-WAY COMMUNICATION
 FLAGGER WILL ASSIST WITH BIKE/VEHICLE TRAFFIC

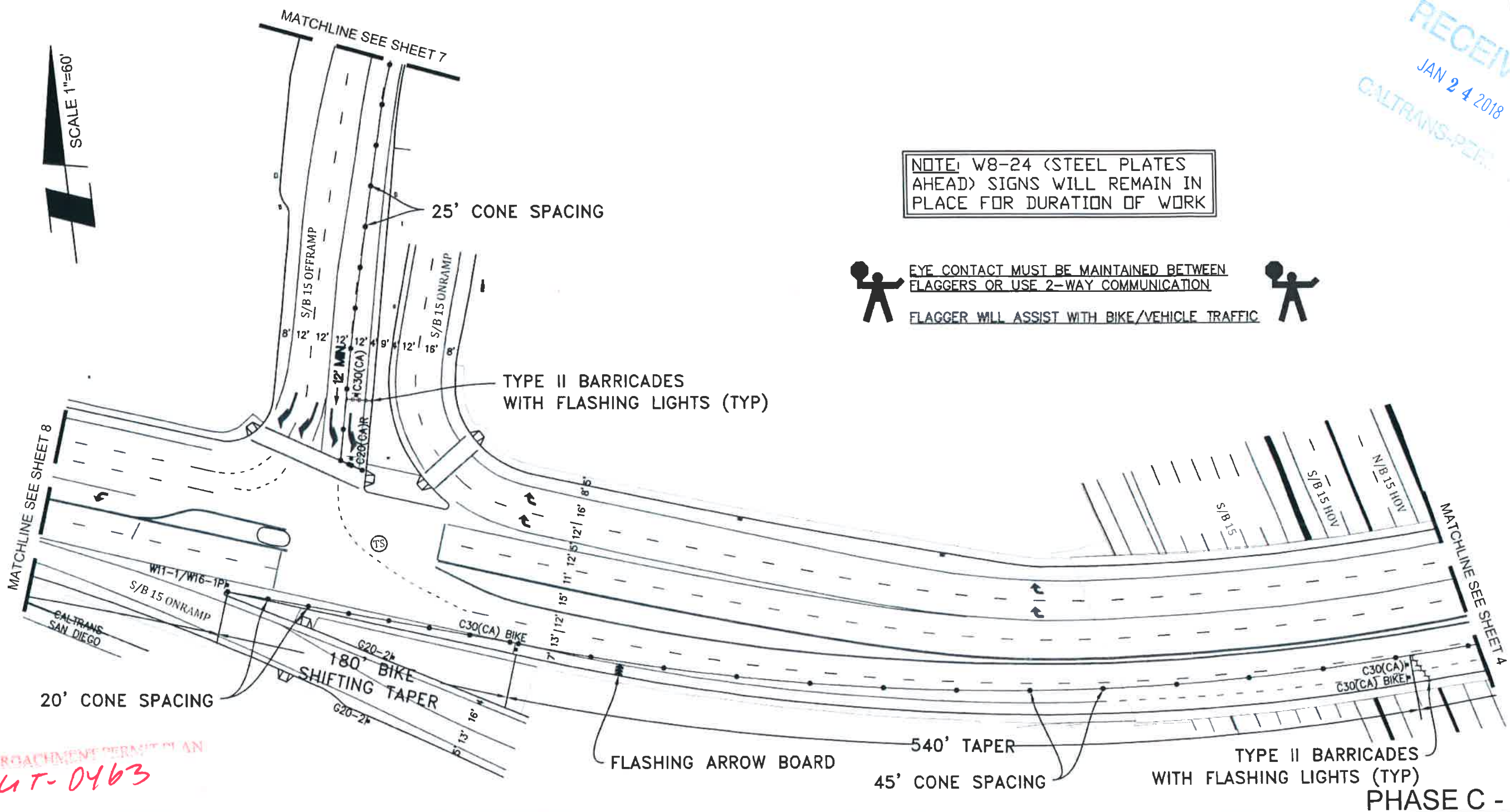

APPROVED ENCROACHMENT PERMIT PLAN
 11-17-647-0463
 Permit No.:

Date: JAN 29 2018

PROJECT NAME: TL23071 - Sycamore Canyon Substation To Penasquitos Substation - 230 KV Underground

DATE: 1/22/2018
 DESIGNED: Clint Jones
 CHECKED BY: Mark Webb

UTILITY SURVEYORS, INC.
AIRX
 Gail McMorran
 President
 2534 EAST EL NORTE PARKWAY SUITE C
 ESCONDIDO, CA 92027
 PHONE: (760) 480-2347
 CELL: (760) 419-3738

NV5
 15092 AVENUE OF SCIENCE, SUITE 200
 SAN DIEGO, CA 92128
 P: 858.385.0500 WWW.NV5.COM

AIRX JOB#: X160218
 THOMAS GRID#: 1209-F6
 MISC/POTHOLE#:
 TYPE OF WORK: TRENCHING / CONDUIT

REGISTERED PROFESSIONAL ENGINEER
 MARK H. WEBB
 No. 46328
 CIVIL
 STATE OF CALIFORNIA

SHEET 6 OF 48

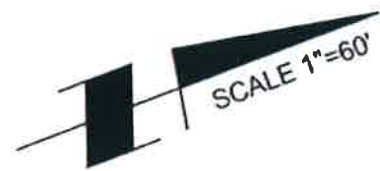

RECEIVED
 JAN 24 2018
 CALTRANS-PEN

NOTE: W8-24 (STEEL PLATES AHEAD) SIGNS WILL REMAIN IN PLACE FOR DURATION OF WORK

EYE CONTACT MUST BE MAINTAINED BETWEEN FLAGGERS OR USE 2-WAY COMMUNICATION
 FLAGGER WILL ASSIST WITH BIKE/VEHICLE TRAFFIC

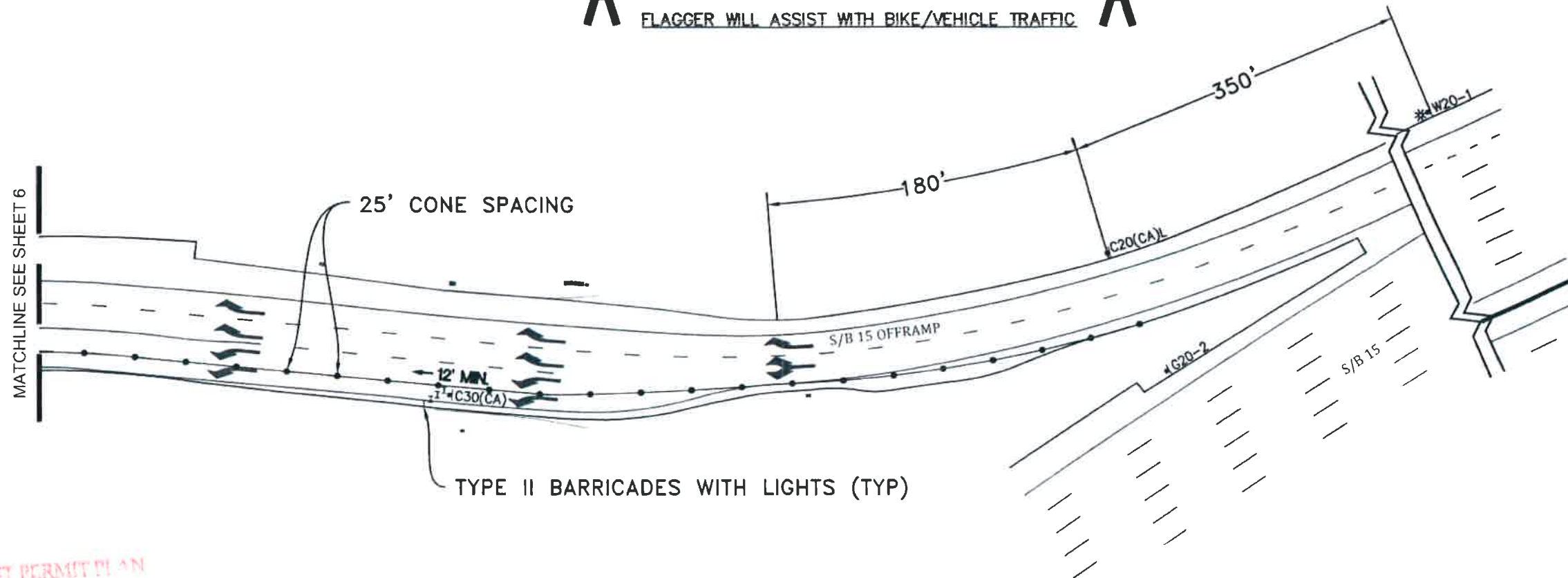

APPROVED ENCROACHMENT PERMIT PLAN
 11-17-64T-0463
 Permit No.:

JAN 29 2018

PHASE C - 1

PROJECT NAME: TL23071 - Sycamore Canyon Substation To Penasquitos Substation - 230 KV Underground

DATE: 1/22/2018
 DESIGNED: Clint Jones
 CHECKED BY: Mark Webb

UTILITY SURVEYORS, INC.
AIRX
 Gail McMorran
 President
 2534 EAST EL NORTE PARKWAY SUITE C
 ESCONDIDO, CA 92027
 PHONE (760) 480-2347
 CELL (760) 419-3738

NV5
 15092 AVENUE OF SCIENCE, SUITE 200
 SAN DIEGO, CA 92128
 P: 858.385.0500 WWW.NV5.COM

AIRX JOB#: X160218
 MISC/POTHOLE#:
 TYPE OF WORK: TRENCHING / CONDUIT

THOMAS GRID#: 1209-F6
 DRAWN FOR: CALTRANS



SHEET 7 OF 48

RECEIVED
 JAN 24 2018
 CALTRANS-PER

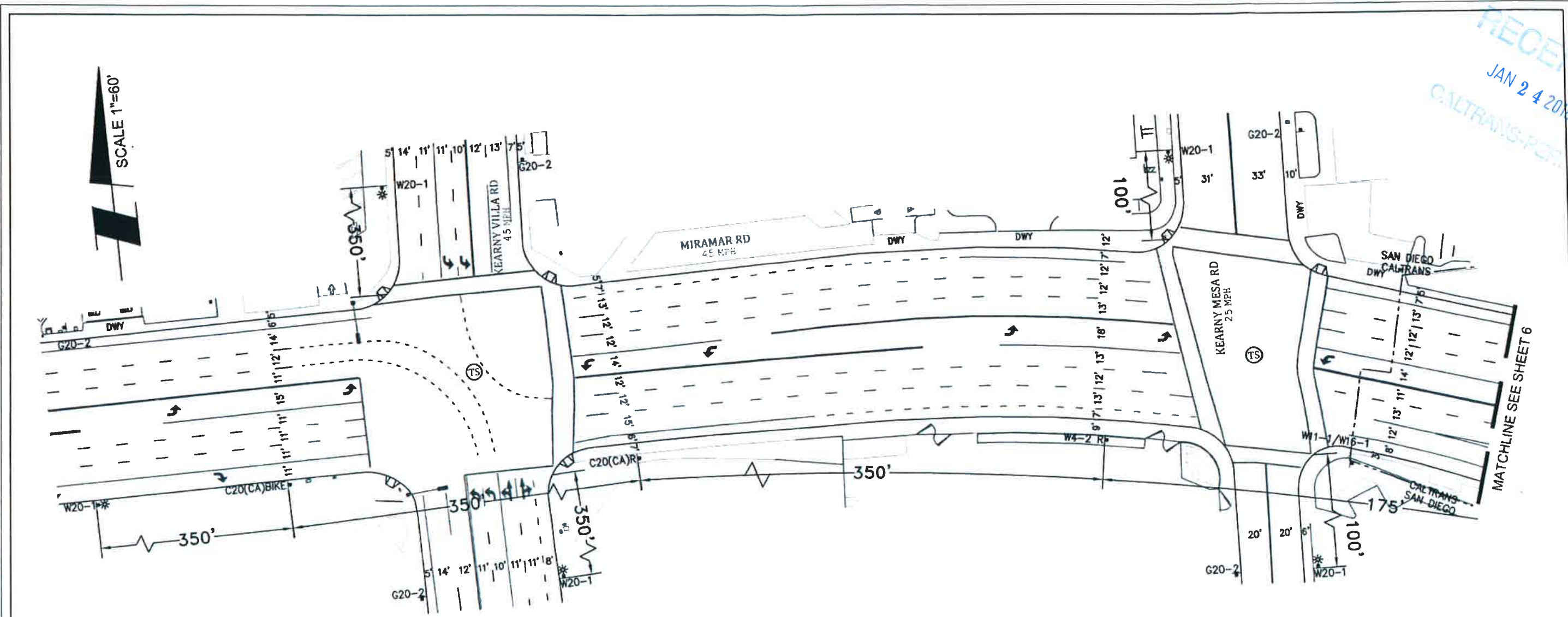

APPROVED ENCROACHMENT PERMIT PLAN
 11-17-6UT-0463
 Permit No.:

Date: _____

 SPCL 1
 JAN 29 2018

EYE CONTACT MUST BE MAINTAINED BETWEEN FLAGGERS OR USE 2-WAY COMMUNICATION
FLAGGER WILL ASSIST WITH BIKE/VEHICLE TRAFFIC

NOTE: W8-24 (STEEL PLATES AHEAD) SIGNS WILL REMAIN IN PLACE FOR DURATION OF WORK

PHASE C - 1

PROJECT NAME: TL23071 - Sycamore Canyon Substation To Penasquitos Substation - 230 KV Underground

DATE: 1/22/2018
 DESIGNED: Clint Jones
 CHECKED BY: Mark Webb

UTILITY SURVEYORS, INC

 Gail McMorrin
 President
 2534 EAST EL NORTE PARKWAY SUITE C
 ESCONDIDO, CA 92027
 PHONE: (760) 480-2347
 CELL: (760) 419-3738

N|V5
 15092 AVENUE OF SCIENCE, SUITE 200
 SAN DIEGO, CA 92128
 P: 858.385.0500 WWW.NV5.COM

AIRX JOB#: X160218
 THOMAS GRID#: 1209-F6
 MISC/POTHOLES#:
 DRAWN FOR: CALTRANS
 TYPE OF WORK: TRENCHING / CONDUIT

REGISTERED PROFESSIONAL ENGINEER
 MARK H. WEBB
 No. 48328

 CIVIL
 STATE OF CALIFORNIA

SHEET 8 OF 48

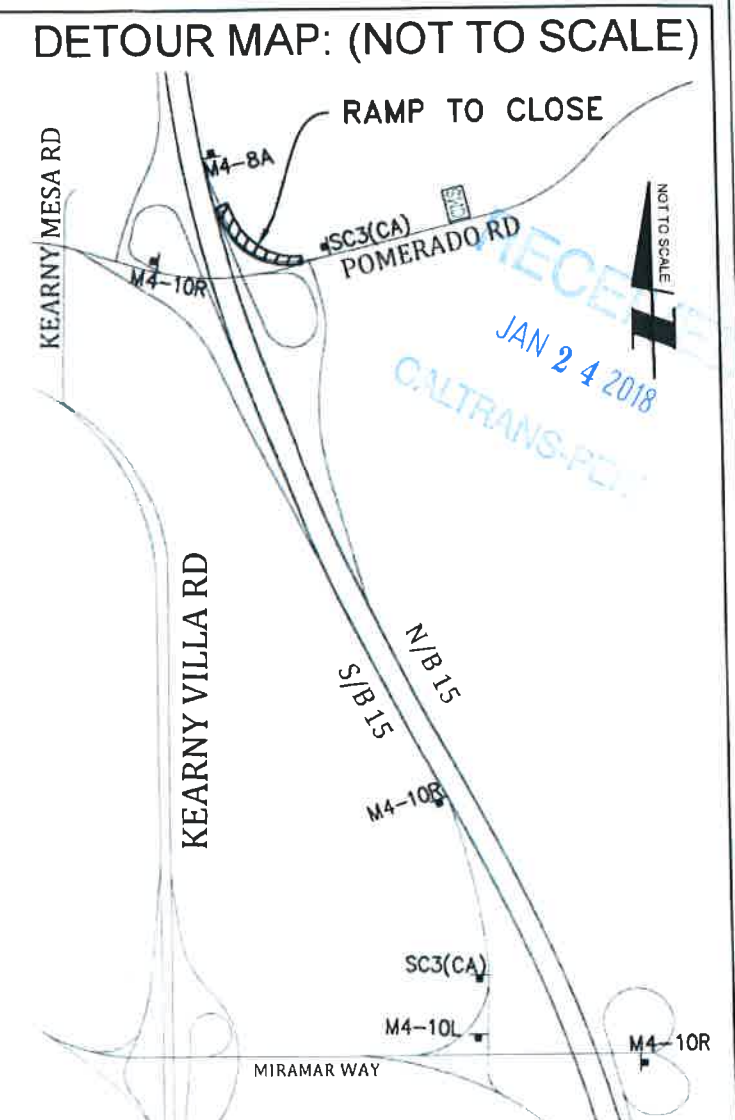
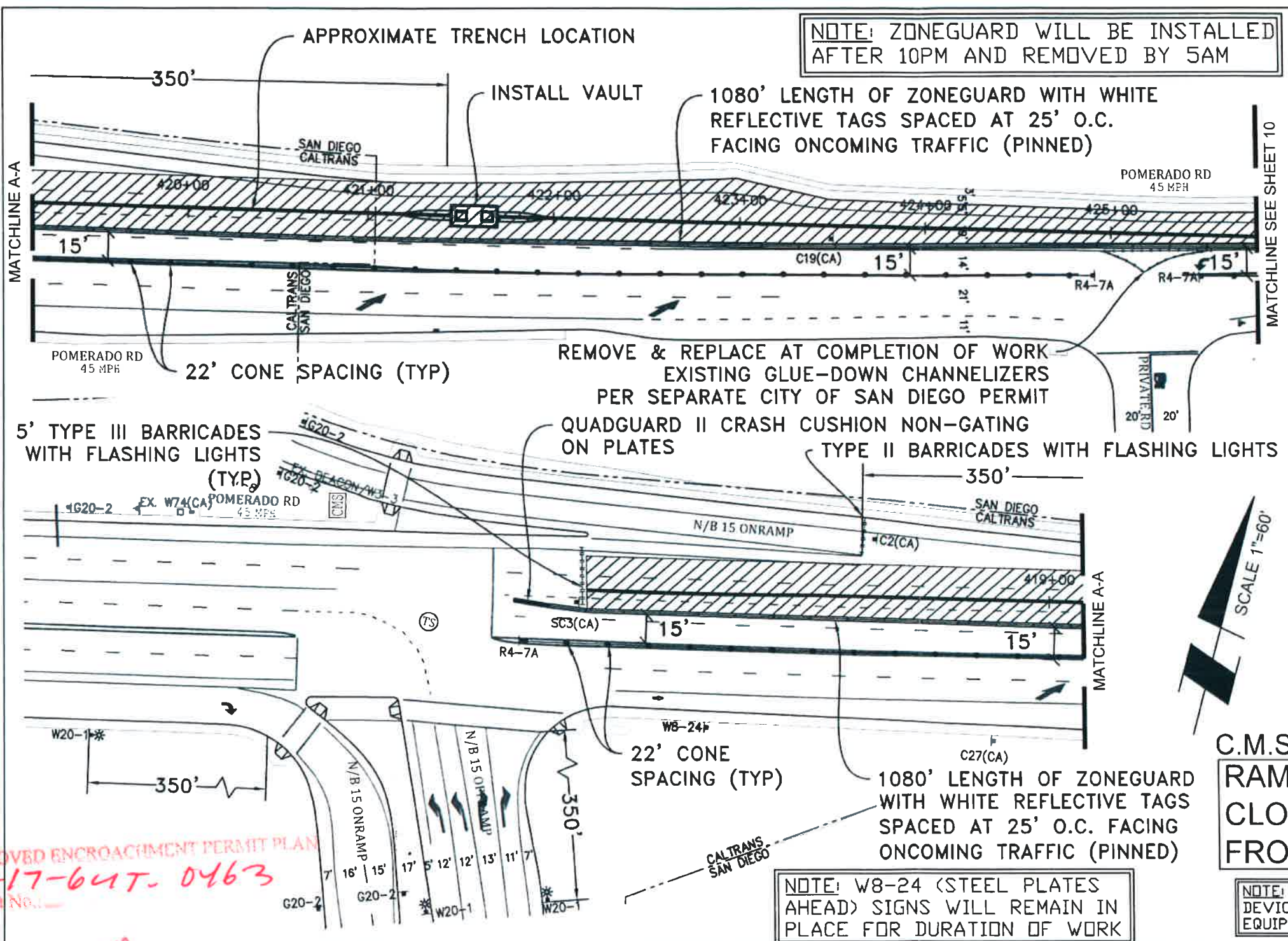

C.M.S. MESSAGE

RAMP CLOSED FROM	DATE TO DATE 10PM-5AM	DETOUR MIRAMAR WAY
------------------	--------------------------	-----------------------

NOTE: ALL CONFLICTING MARKERS AND DEVICES WILL BE REMOVED WHEN EQUIPMENT IS NOT IN USE

PHASE C - 2

APPROVED ENCROACHMENT PERMIT PLAN
11-17-64T-0463
Permit No. 11-17-64T-0463
Date: JAN 29 2018

PROJECT NAME: TL23071 - Sycamore Canyon Substation To Penasquitos Substation - 230 KV Underground

 Gail McMorran President 2534 EAST EL NORTE PARKWAY, SUITE C ESCONDIDO, CA 92027 PHONE: (760) 480-7347 CELL: (760) 419-3738	 15092 AVENUE OF SCIENCE, SUITE 200 SAN DIEGO, CA 92128 P: 858 385 0500 WWW.NV5.COM	AIRX JOB#: X160218	THOMAS GRID#: 1209-F6
		MISC/POTHOLE#:	DRAWN FOR: CALTRANS
TYPE OF WORK: TRENCHING / CONDUIT		 DATE: 1/22/2018 DESIGNED: Clint Jones CHECKED BY: Mark Webb	

SHEET 9 OF 48



NOTE: ZONEGUARD WILL BE INSTALLED AFTER 10PM AND REMOVED BY 5AM

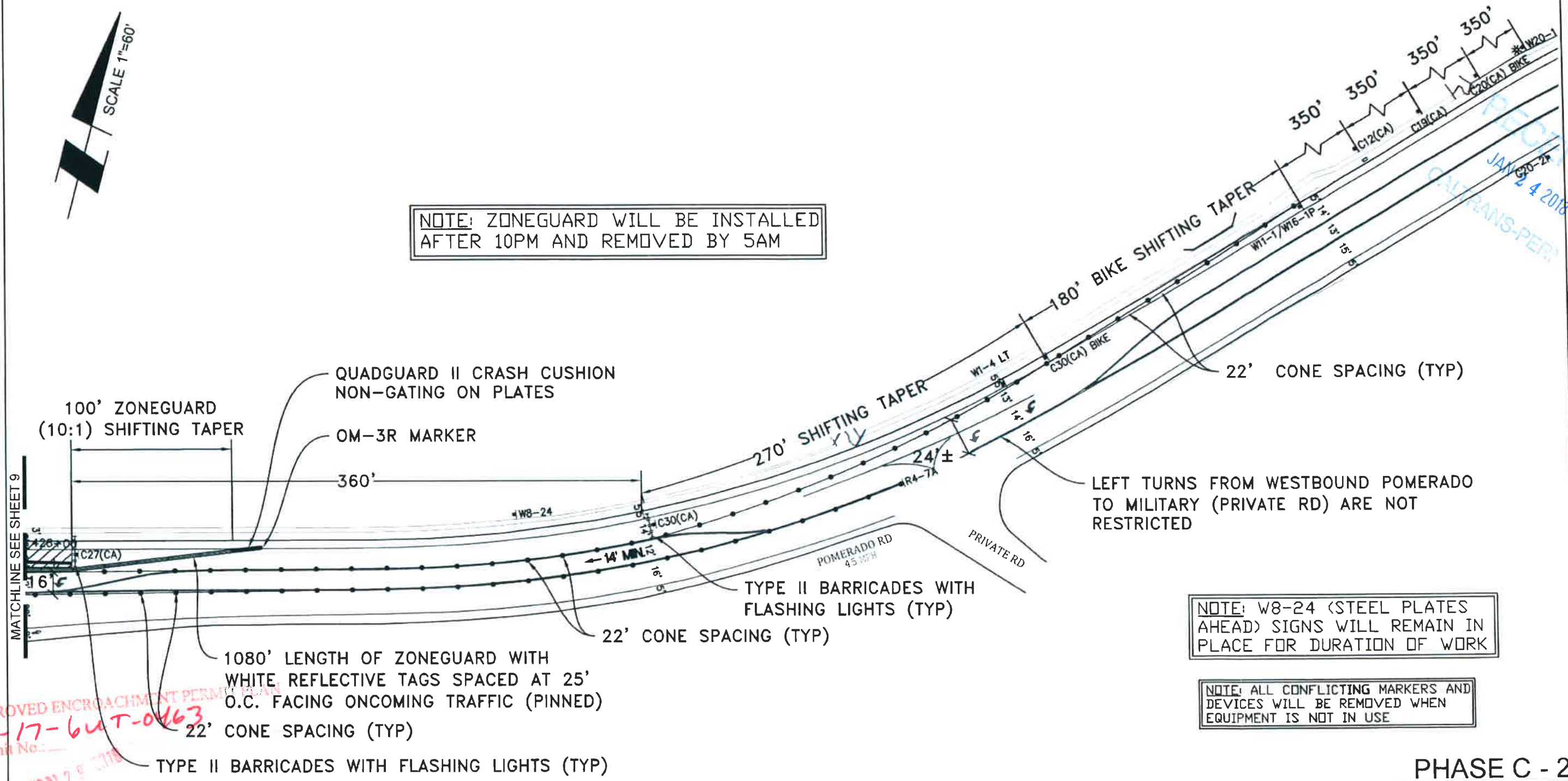

NOTE: W8-24 (STEEL PLATES AHEAD) SIGNS WILL REMAIN IN PLACE FOR DURATION OF WORK

NOTE: ALL CONFLICTING MARKERS AND DEVICES WILL BE REMOVED WHEN EQUIPMENT IS NOT IN USE

PHASE C - 2

PROJECT NAME: TL23071 - Sycamore Canyon Substation To Penasquitos Substation - 230 KV Underground

DATE: 1/22/2018
 DESIGNED: Clint Jones
 CHECKED BY: Mark Webb

AIRX SURVEYORS, INC.
 Gail McMorrin
 President
 2534 EAST EL NORTE PARKWAY SUITE C
 ESCONDIDO, CA 92027
 PHONE: (760) 480-2347
 CELL: (760) 419-3738

NV5
 15092 AVENUE OF SCIENCE, SUITE 200
 SAN DIEGO, CA 92128
 P: 858.385.0500 WWW.NV5.COM

AIRX JOB#: X160218
 MISC/POTHOLES#: _____
 TYPE OF WORK: TRENCHING / CONDUIT

THOMAS GRID#: 1209-F6
 DRAWN FOR: CALTRANS



SHEET 10 OF 48

RAMP DETAIL: (NOT TO SCALE)

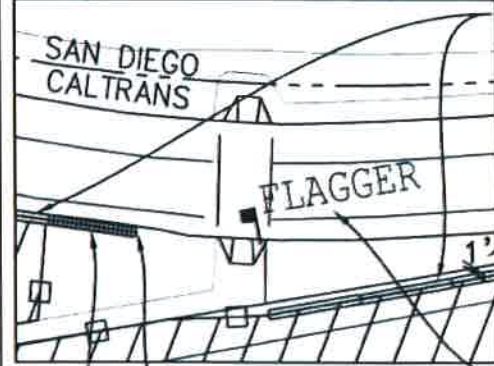

ZONEGUARD WITH YELLOW REFLECTIVE TAGS SPACED AT 25' O.C. FACING ONCOMING TRAFFIC WITH 6' TALL CHAINLINK FENCE WITH GREEN MESH (PINNED)

KEEP ZONEGUARD MINIMUM OF 1' FROM CURB

FLAGGERS AND STEEL PLATES WILL BE USED WHEN WORK ON SIDEWALK IS BEING PERFORMED

QUADGUARD II CRASH CUSHION NON-GATING ON PLATES

FENCE WILL NOT BE PLACED ON SIDEWALK SIDEWALK WILL BE FREE OF DEBRIS AND EQUIPMENT THROUGH WORK AREA

QUADGUARD II CRASH CUSHION NON-GATING ON PLATES

NOTE: ZONEGUARD WILL BE INSTALLED AFTER 10PM AND REMOVED BY 5AM

INSTALL CORRUGATED STEEL PANEL AND GRAVEL PER CALTRANS PLAN T58

6' TALL CHAINLINK FENCE WITH GREEN MESH

BORE PIT

APPROXIMATE TRENCH LOCATION

280' LENGTH OF ZONEGUARD WITH YELLOW REFLECTIVE TAGS SPACED AT 25' O.C. FACING ONCOMING TRAFFIC WITH 6' TALL CHAINLINK FENCE WITH GREEN MESH (PINNED)

SEE RAMP DETAIL

ZONEGUARD INTERSECTION DETAIL: (NOT TO SCALE)

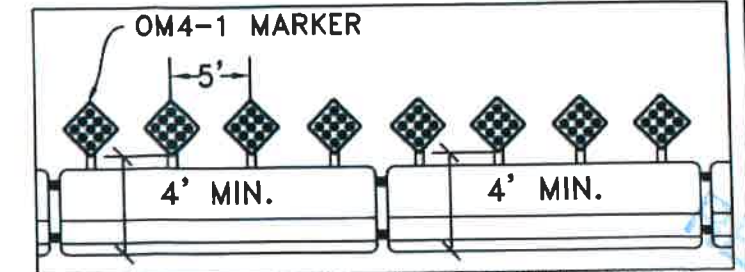

SPACE OM4-1 MARKERS 4' OFF GROUND SPACED AT 5' O.C. FACING ONCOMING TRAFFIC FACING ONCOMING TRAFFIC(TYP) INSIDE INTERSECTION

275' LENGTH OF ZONEGUARD WITH YELLOW REFLECTIVE TAGS SPACED AT 25' O.C. FACING ONCOMING TRAFFIC (PINNED)

180' ZONEGUARD 10:1 SHIFTING TAPER



560' LENGTH OF ZONEGUARD WITH WHITE REFLECTIVE TAGS SPACED AT 25' O.C. FACING ONCOMING TRAFFIC (PINNED)

NOTE: ALL CONFLICTING MARKERS AND DEVICES WILL BE REMOVED WHEN EQUIPMENT IS NOT IN USE

NOTE: W8-24 (STEEL PLATES AHEAD) SIGNS WILL REMAIN IN PLACE FOR DURATION OF WORK

NOTE: WHEN ZONEGUARD IS LESS THAN 2' FROM TRENCH PIN ZONEGUARD PER CALTRANS STANDARD PLANS

FLAGGERS WILL SAFELY GUIDE PEDESTRIANS THROUGH WORK AREA SEE ZONEGUARD INTERSECTION DETAIL

TYPE II BARRICADES WITH FLASHING LIGHTS (TYP)

20' CONE SPACING REMOVE EXISTING DETAIL 40 USE TEMPORARY TABS DURING NON-WORKING HOURS

25' CONE SPACING

PHASE C - 3

APPROVED ENCROACHMENT PERMIT PLAN
11-17-6UT-0463
Permit No.:

Date: JAN 29 2018

PROJECT NAME: TL23071 - Sycamore Canyon Substation To Penasquitos Substation - 230 KV Underground

UTILITY SURVEYORS, INC.
AIRX
Gail McMorran
President
2534 EAST EL NORTE PARKWAY SUITE C
ESCONDIDO, CA 92027
PHONE: (760) 480-2347
CELL: (760) 419-3738

NV5
15092 AVENUE OF SCIENCE, SUITE 200
SAN DIEGO, CA 92128
P: 858 385 0500 WWW.NV5.COM

AIRX JOB#: X160218

MISC/POTHOLE#:

TYPE OF WORK: TRENCHING / CONDUIT

THOMAS GRID#: 1209-F6

DRAWN FOR: CALTRANS



DATE: 1/22/2018
DESIGNED: Clint Jones
CHECKED BY: Mark Webb

SHEET 11 OF 48

RECEIVED
 JAN 24 2018
 CALTRANS-PER
 SCALE 1"=60'

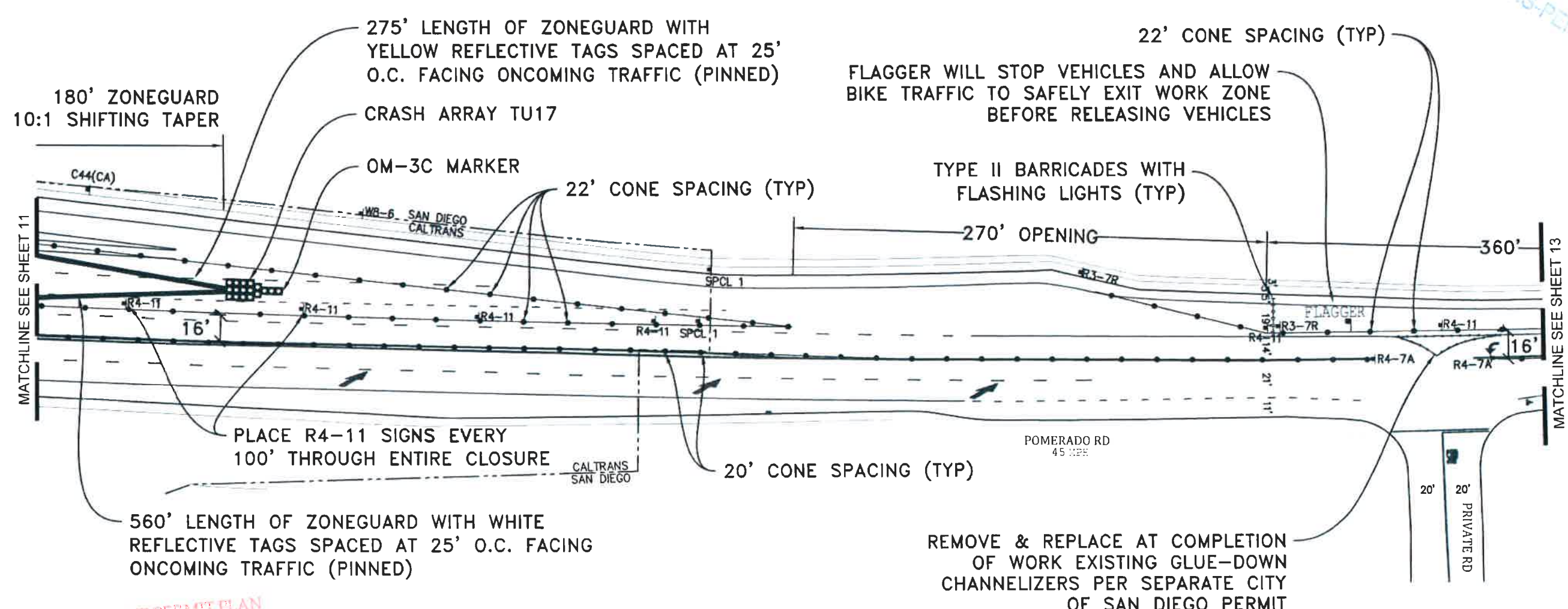

APPROVED ENCROACHMENT PERMIT PLAN
 11-17-647-0963
 Permit No.:
 Date: JAN 29 2018

NOTE: KEEP ZONEGUARD 1' FROM CURB

NOTE: ALL CONFLICTING MARKERS AND DEVICES WILL BE REMOVED WHEN EQUIPMENT IS NOT IN USE

NOTE: WHEN ZONEGUARD IS LESS THAN 2' FROM TRENCH PIN ZONEGUARD PER CALTRANS STANDARD PLANS

NOTE: ZONEGUARD WILL BE INSTALLED AFTER 10PM AND REMOVED BY 5AM



PHASE C - 3

PROJECT NAME: TL23071 - Sycamore Canyon Substation To Penasquitos Substation - 230 KV Underground

DATE: 1/22/2018
 DESIGNED: Clint Jones
 CHECKED BY: Mark Webb

UTILITY SURVEYORS, INC.
AIRX
 Gail McMorrán
 President
 2534 EAST EL NORTE PARKWAY SUITE C
 ESCONDIDO, CA 92027
 PHONE: (760) 480-2347
 CELL: (760) 419-3738

NV5
 15092 AVENUE OF SCIENCE, SUITE 200
 SAN DIEGO, CA 92128
 P: 858 385 0500 WWW.NV5.COM

AIRX JOB#: X160218
 MISC/POTHOLE#:
 TYPE OF WORK: TRENCHING / CONDUIT

THOMAS GRID#: 1209-F6
 DRAWN FOR: CALTRANS



SHEET 12 OF 48

RECEIVED
JAN 24 2018
CALTRANS-PER

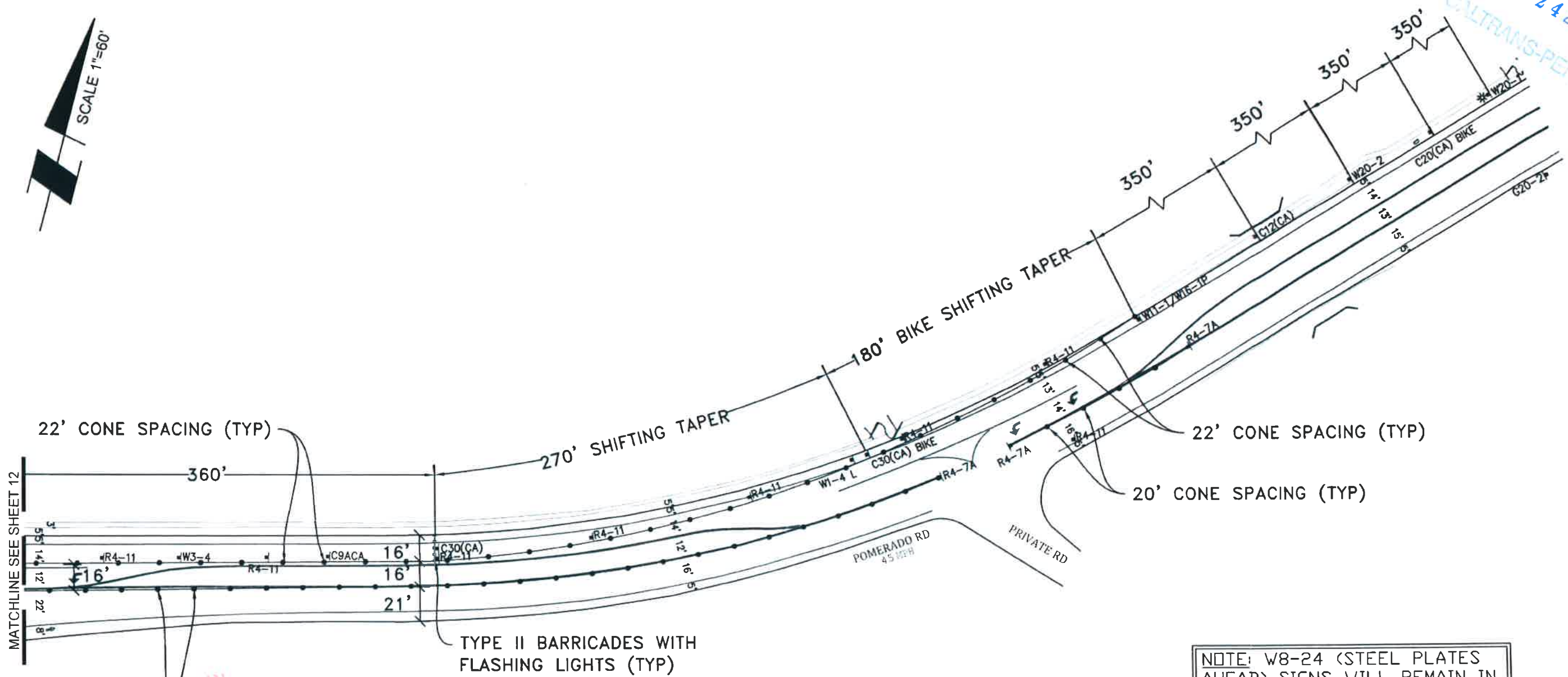

NOTE: W8-24 (STEEL PLATES AHEAD) SIGNS WILL REMAIN IN PLACE FOR DURATION OF WORK

APPROVED ENCROACHMENT PERMIT PLAN
11-17-64T-0463
Permit No.:

Date: JAN 29 2018

PHASE C - 3

PROJECT NAME: TL23071 - Sycamore Canyon Substation To Penasquitos Substation - 230 KV Underground

DATE: 1/22/2018
DESIGNED: Clint Jones
CHECKED BY: Mark Webb

UTILITY SURVEYORS, INC

 2534 EAST EL NORTE PARKWAY SUITE C
 ESCONDIDO, CA 92027
 PHONE (760) 480-2347
 CELL: (760) 418-3738

N|V|5
 15092 AVENUE OF SCIENCE, SUITE 200
 SAN DIEGO, CA 92128
 P: 858 385.0500 WWW.NV5.COM

AIRX JOB#: X160218
 THOMAS GRID#: 1209-F6
 MISC/POTHOLE#: _____
 DRAWN FOR: CALTRANS
 TYPE OF WORK: TRENCHING / CONDUIT



SHEET 13 OF 48

RECEIVED
 JAN 24 2018
 CALTRANS-PER

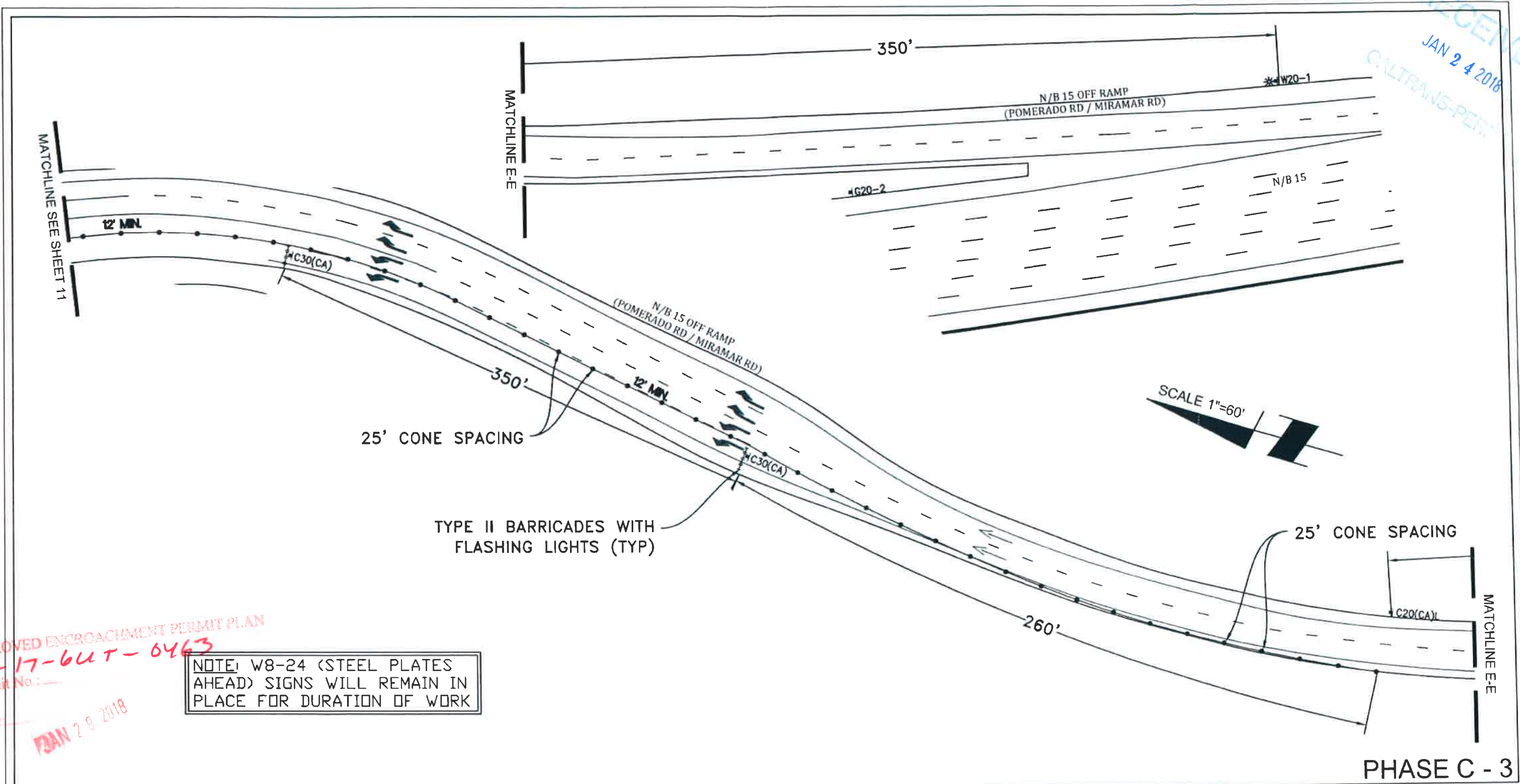

APPROVED ENCROACHMENT PERMIT PLAN
 11-17-64T-0463
 Permit No.:
 Date: JAN 29 2018

NOTE: W8-24 (STEEL PLATES AHEAD) SIGNS WILL REMAIN IN PLACE FOR DURATION OF WORK

PHASE C - 3

PROJECT NAME: TL23071 - Sycamore Canyon Substation To Penasquitos Substation - 230 KV Underground

DATE: 1/22/2018
 DESIGNED: Clint Jones
 CHECKED BY: Mark Webb

UTILITY SURVEYORS, INC.
AIRX
 Gail McMorran
 President
 2534 EAST EL NORTE PARKWAY SUITE C
 ESCONDIDO, CA 92027
 PHONE (760) 480-2347
 CELL: (760) 419-3738

N|V|5
 15092 AVENUE OF SCIENCE, SUITE 200
 SAN DIEGO, CA 92128
 P: 858 385.0500 WWW.NV5.COM

AIRX JOB#: X160218
 MISC/POTHOLES#:
 TYPE OF WORK: TRENCHING / CONDUIT

THOMAS GRID#: 1209-F6
 DRAWN FOR: CALTRANS



SHEET 14 OF 48

RECEIVED
JAN 24 2018

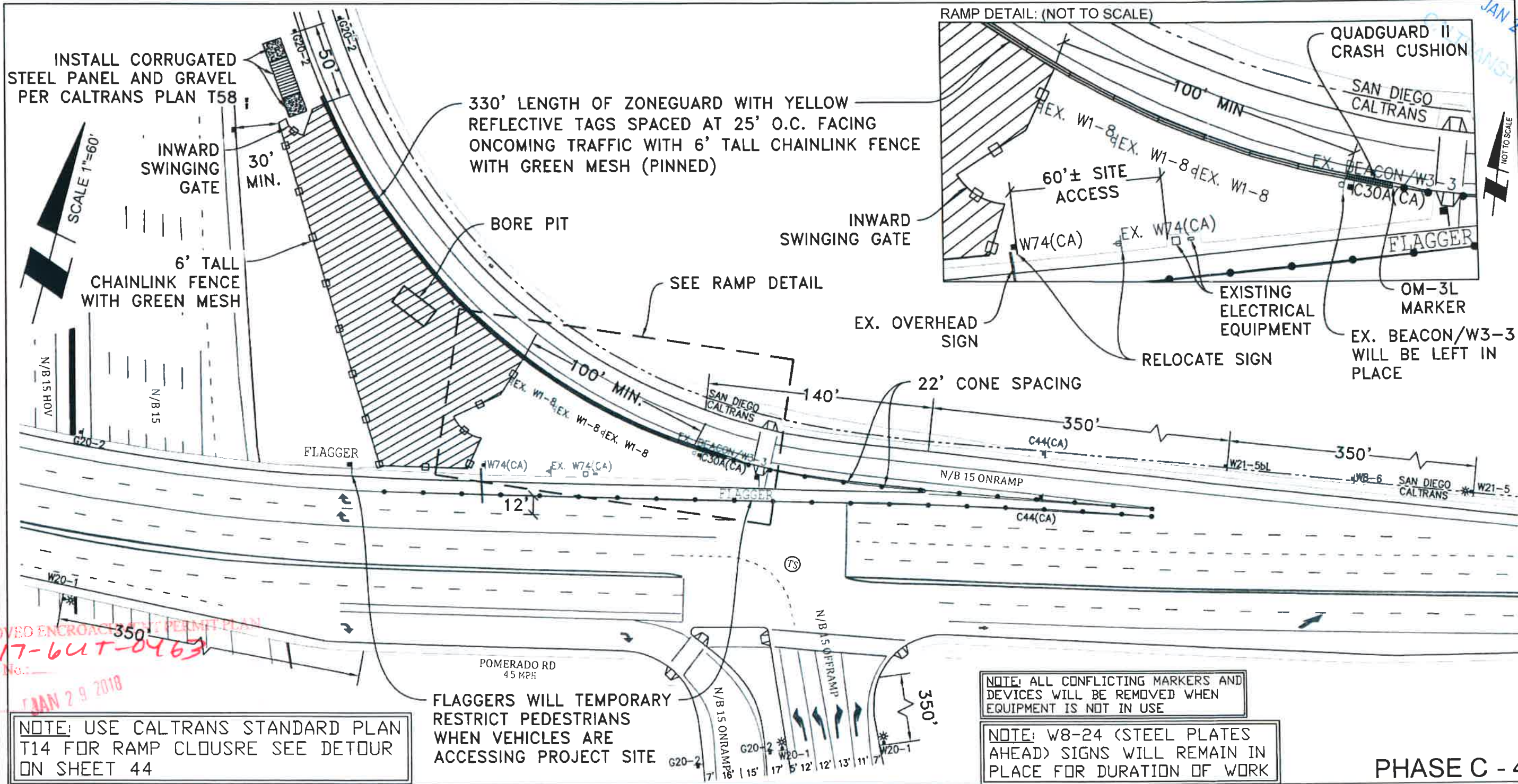

APPROVED ENCROACHMENT PERMIT PLAN
 11-17-641T-0463
 Permit No.:
 Date: JAN 29 2018

NOTE: USE CALTRANS STANDARD PLAN T14 FOR RAMP CLOSURE SEE DETOUR ON SHEET 44

FLAGGERS WILL TEMPORARY RESTRICT PEDESTRIANS WHEN VEHICLES ARE ACCESSING PROJECT SITE

PHASE C - 4

PROJECT NAME: TL23071 - Sycamore Canyon Substation To Penasquitos Substation - 230 KV Underground

DATE: 1/22/2018
 DESIGNED: Clint Jones
 CHECKED BY: Mark Webb

UTILITY SURVEYORS, INC.
AIRX
 Gail McMorran
 President
 2534 EAST EL NORTE PARWAY SUITE C
 ESCONDIDO, CA 92027
 PHONE (760) 480-2347
 CELL (760) 419-3738

N|V 5
 15092 AVENUE OF SCIENCE, SUITE 200
 SAN DIEGO, CA 92128
 P: 858 385.0500 WWW.NV5.COM

AIRX JOB#: X160218
 MISC/POTHOLE#:
 TYPE OF WORK: BORING

THOMAS GRID#: 1209-F6
 DRAWN FOR: CALTRANS



SHEET 15 OF 48

RECEIVED
 JAN 24 2018
 CALTRANS-PER

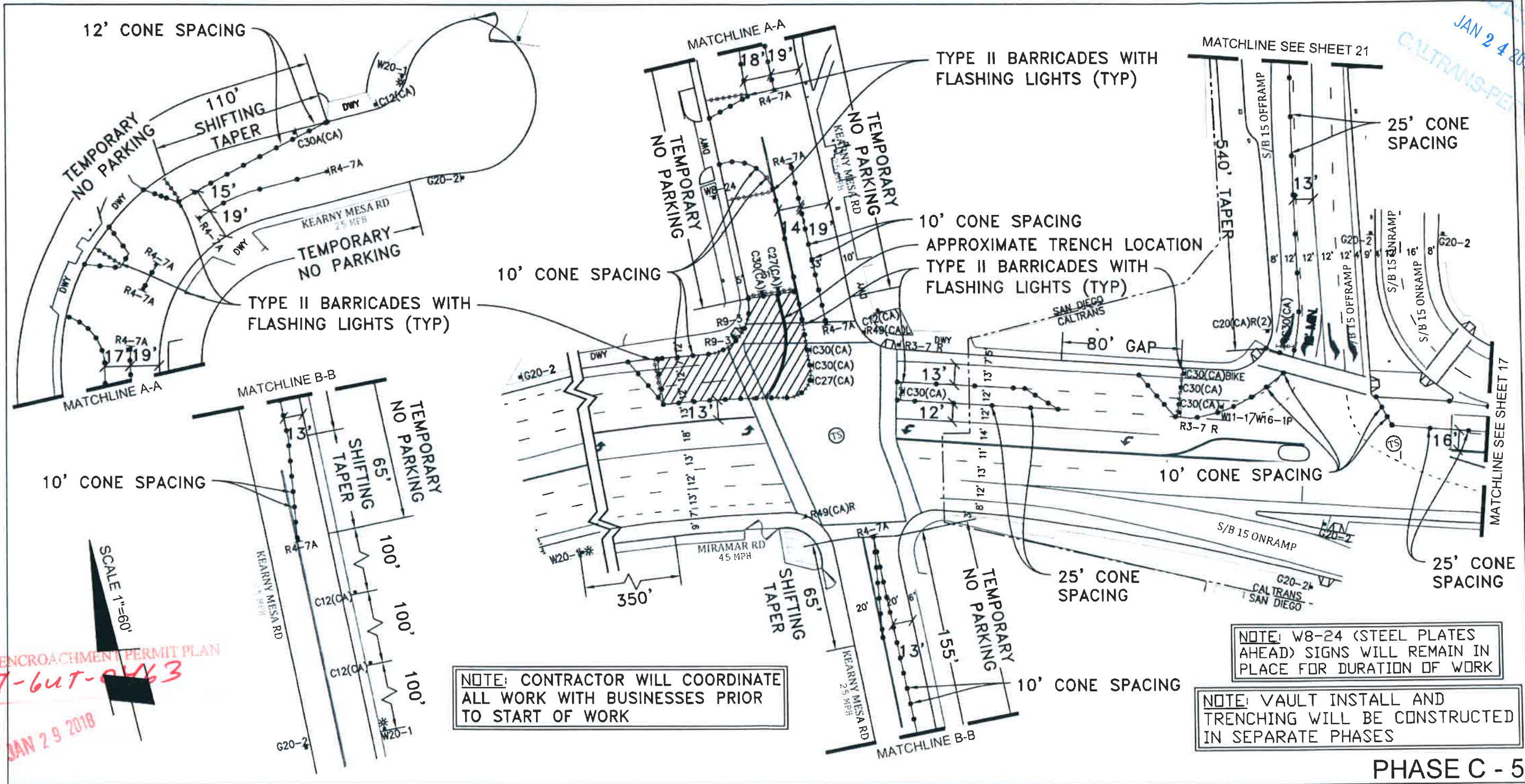

NOTE: W8-24 (STEEL PLATES AHEAD) SIGNS WILL REMAIN IN PLACE FOR DURATION OF WORK

NOTE: VAULT INSTALL AND TRENCHING WILL BE CONSTRUCTED IN SEPARATE PHASES

NOTE: CONTRACTOR WILL COORDINATE ALL WORK WITH BUSINESSES PRIOR TO START OF WORK

PHASE C - 5

APPROVED ENCROACHMENT PERMIT PLAN
 11-17-6UT-0463
 Permit No.:
 Date: JAN 29 2018

PROJECT NAME: TL23071 - Sycamore Canyon Substation To Penasquitos Substation - 230 KV Underground

AIRX SURVEYORS, INC.
 Gail McMorran
 President
 2534 EAST EL NORTE PARKWAY SUITE C
 ESCONDIDO, CA 92027
 PHONE (760) 480-2347
 CELL (760) 419-3738

N|V|5
 15092 AVENUE OF SCIENCE, SUITE 200
 SAN DIEGO, CA 92128
 P: 858.385.0500 WWW.NV5.COM

AIRX JOB#: X160218
 MISC/POTHOLES#:
 TYPE OF WORK: TRENCHING / CONDUIT

THOMAS GRID#: 1209-F6
 DRAWN FOR: SAN DIEGO



DATE: 1/22/2018
 DESIGNED: Clint Jones
 CHECKED BY: Mark Webb

SHEET 16 OF 48

RECEIVED
 JAN 24 2018
 CALTRANS-PET

NOTE: ALL CONFLICTING MARKERS AND DEVICES WILL BE REMOVED WHEN EQUIPMENT IS NOT IN USE

NOTE: W8-24 <STEEL PLATES AHEAD> SIGNS WILL REMAIN IN PLACE FOR DURATION OF WORK

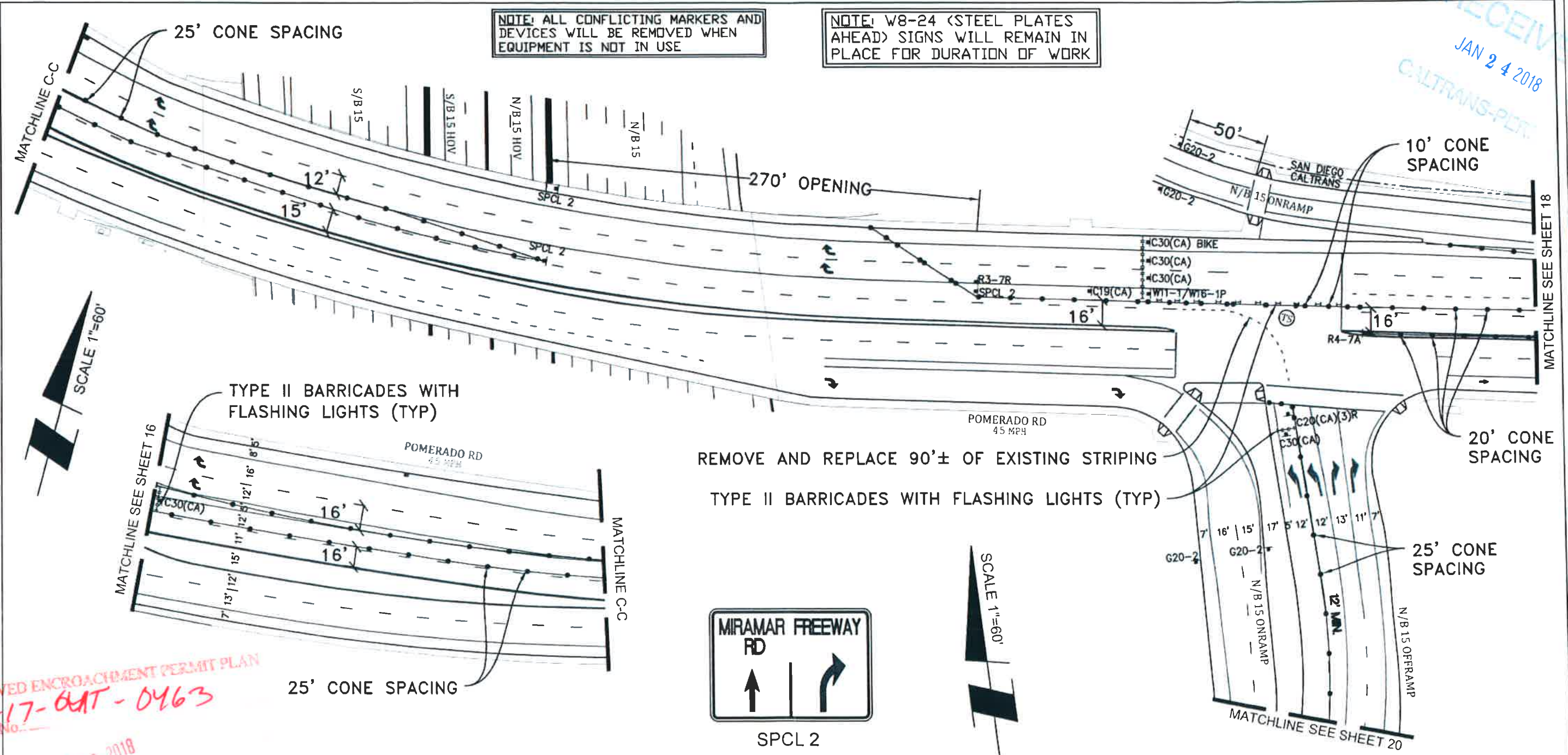

APPROVED ENCROACHMENT PERMIT PLAN
 11-17-04AT-0463
 Permit No. _____
 Date: JAN 29 2018

PHASE C - 5

PROJECT NAME: TL23071 - Sycamore Canyon Substation To Penasquitos Substation - 230 KV Underground

UTILITY SURVEYORS, INC.
AIRX
 Gail McMorran
 President
 2534 EAST EL NORTE PARKWAY SUITE C
 ESCONDIDO, CA 92027
 PHONE (760) 480-2347
 CELL (760) 419-3738

NV5
 15092 AVENUE OF SCIENCE, SUITE 200
 SAN DIEGO, CA 92128
 P: 858.385.0500 WWW.NV5.COM

AIRX JOB#: X160218
 MISC/POTHOLE#: _____
 TYPE OF WORK: TRENCHING / CONDUIT

THOMAS GRID#: 1209-F6
 DRAWN FOR: SAN DIEGO



DATE: 1/22/2018
 DESIGNED: Clint Jones
 CHECKED BY: Mark Webb

SHEET 17 OF 48

RECEIVED
 JAN 24 2018
 CALTRANS-PER
 SCALE 1"=60'

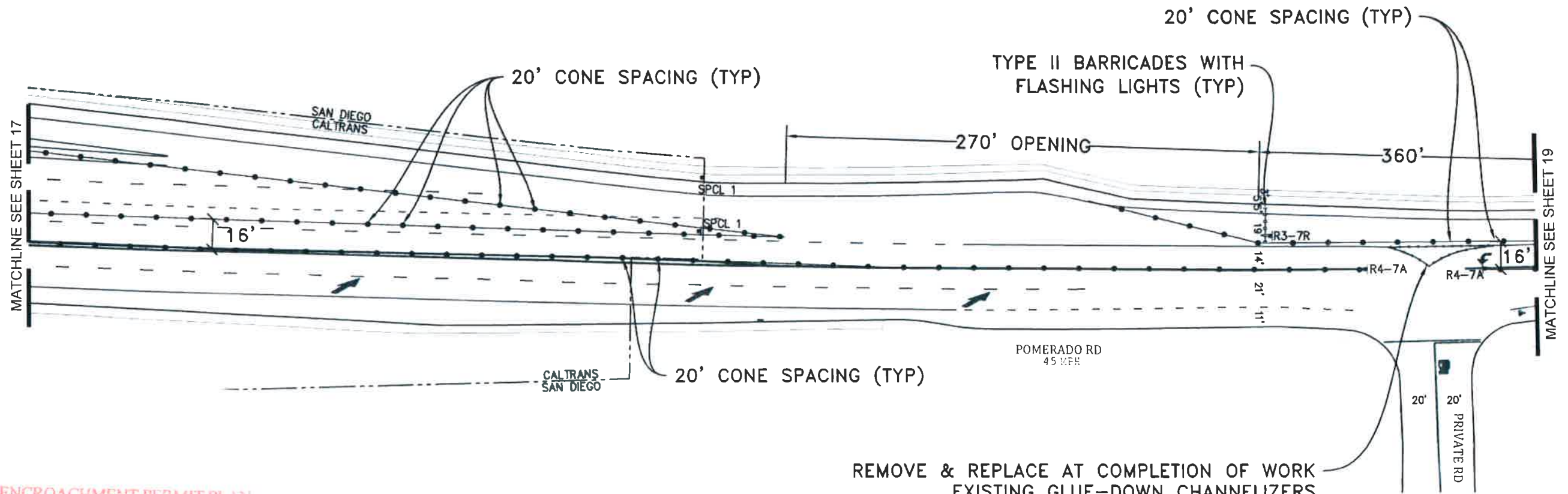

REMOVE & REPLACE AT COMPLETION OF WORK
 EXISTING GLUE-DOWN CHANNELIZERS
 PER SEPARATE CITY OF SAN DIEGO PERMIT

APPROVED ENCROACHMENT PERMIT PLAN
 11-17-647-0463
 Permit No.:

Date: **JAN 29 2018**



SPCL 1

PHASE C - 5

PROJECT NAME: TL23071 - Sycamore Canyon Substation To
 Penasquitos Substation - 230 KV Underground

DATE: 1/22/2018
 DESIGNED: Clint Jones
 CHECKED BY: Mark Webb

UTILITY SURVEYORS, INC.
AIRX
 Gail McMorran
 President
 2534 EAST EL NORTE PARKWAY SUITE C
 ESCONDIDO, CA 92027
 PHONE (760) 480-2347
 CELL (760) 419-3738

NV5
 15092 AVENUE OF SCIENCE, SUITE 200
 SAN DIEGO, CA 92128
 P: 858 385 0500 WWW.NV5.COM

AIRX JOB#: X160218
 THOMAS GRID#: 1209-F6
 MISC/POTHOLE#:
 DRAWN FOR: SAN DIEGO
 TYPE OF WORK: TRENCHING / CONDUIT



SHEET 18 OF 48



RECEIVED
JAN 24 2018
CIVIL ENGINEER

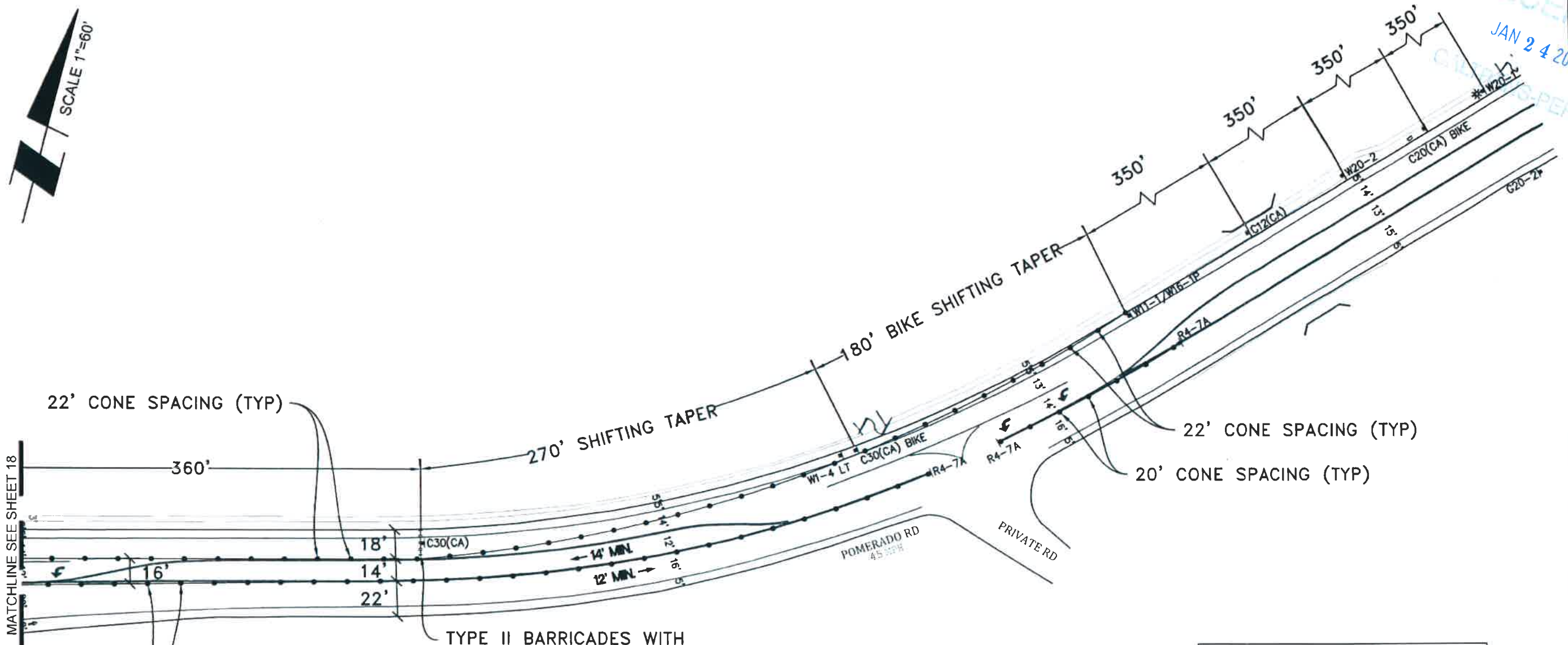

NOTE: W8-24 (STEEL PLATES AHEAD) SIGNS WILL REMAIN IN PLACE FOR DURATION OF WORK

APPROVED ENCROACHMENT PERMIT PLAN
11-17-64T-0463
Permit No.:
Date: JAN 29 2018

PHASE C - 5

PROJECT NAME: TL23071 - Sycamore Canyon Substation To Penasquitos Substation - 230 KV Underground

DATE: 1/22/2018
DESIGNED: Clint Jones
CHECKED BY: Mark Webb

UTILITY SURVEYORS, INC.
AIRX
Gail McMorran
President
2534 EAST EL NORTE PARKWAY SUITE C
ESCONDIDO, CA 92027
PHONE (760) 480-2347
CELL: (760) 419-3738

NV5
15092 AVENUE OF SCIENCE, SUITE 200
SAN DIEGO, CA 92128
P: 858.385.0500 WWW.NV5.COM

AIRX JOB#: X160218
MISC/POTHOLES#:
TYPE OF WORK: TRENCHING / CONDUIT

THOMAS GRID#: 1209-F6
DRAWN FOR: SAN DIEGO



SHEET 19 OF 48

RECEIVED
 JAN 24 2018
 CALTRANS-PERT

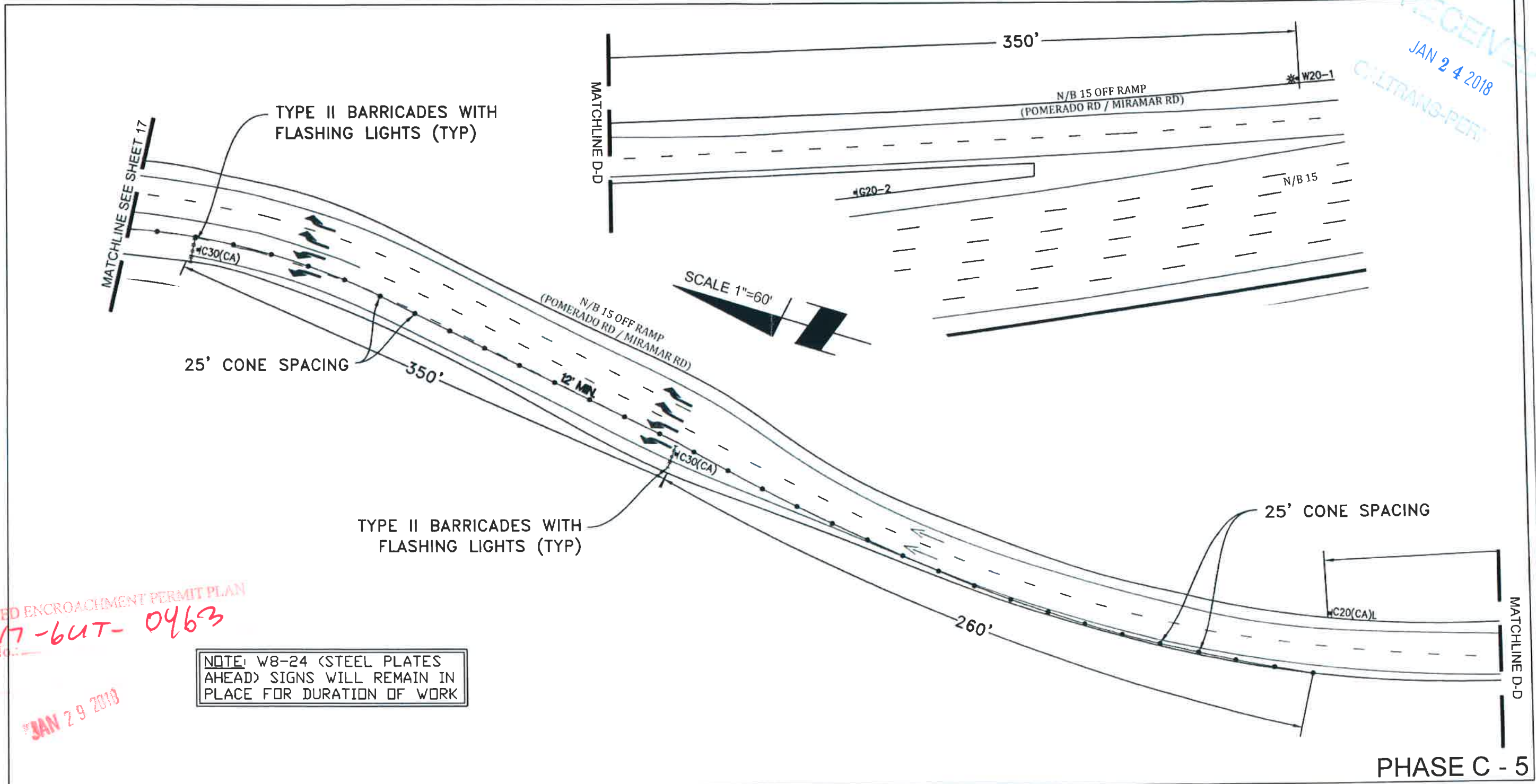

APPROVED ENCROACHMENT PERMIT PLAN
 11-17-64T-0463
 Permit No. _____
 Date: _____
 JAN 29 2018

NOTE: W8-24 (STEEL PLATES AHEAD) SIGNS WILL REMAIN IN PLACE FOR DURATION OF WORK

PHASE C - 5

PROJECT NAME: TL23071 - Sycamore Canyon Substation To Penasquitos Substation - 230 KV Underground

UTILITY SURVEYORS, INC.
AIRX
 2534 EAST EL NORTE PARKWAY, SUITE C
 ESCONDIDO, CA 92027
 PHONE (760) 480-2347
 CELL (760) 419-3738

N|V|5
 15092 AVENUE OF SCIENCE, SUITE 200
 SAN DIEGO, CA 92128
 P: 858.385.0500 WWW.NV5.COM

AIRX JOB#: X160218
 MISC/POTHOLE#: _____
 TYPE OF WORK: TRENCHING / CONDUIT

THOMAS GRID#: 1209-F6
 DRAWN FOR: SAN DIEGO



DATE: 1/22/2018
 DESIGNED: Clint Jones
 CHECKED BY: Mark Webb

SHEET 20 OF 48

RECEIVED
 JAN 24 2018
 TRANS-PE



NOTE: W8-24 (STEEL PLATES AHEAD) SIGNS WILL REMAIN IN PLACE FOR DURATION OF WORK

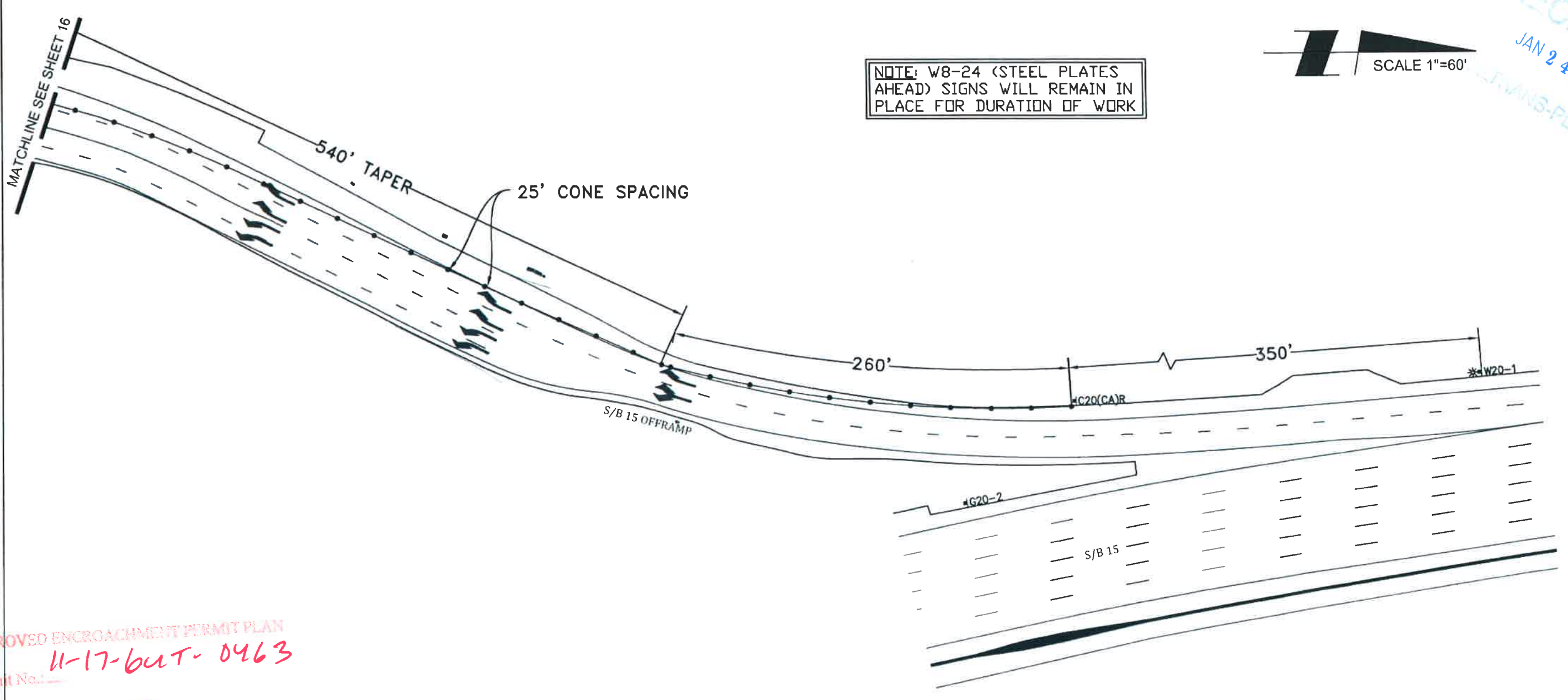

APPROVED ENCROACHMENT PERMIT PLAN
 Permit No. **11-17-but-0463**
 Date **JAN 29 2018**

PHASE C - 5

PROJECT NAME: TL23071 - Sycamore Canyon Substation To Penasquitos Substation - 230 KV Underground

UTILITY SURVEYORS, INC.
AIRX
 2534 EAST EL NORTE PARKWAY SUITE C
 ESCONDIDO, CA 92027
 PHONE (760) 480-2347
 CELL (760) 418-3738

NV5
 15092 AVENUE OF SCIENCE, SUITE 200
 SAN DIEGO, CA 92128
 P: 858.385.0500 WWW.NV5.COM

AIRX JOB#: X160218
 MISC/POTHOLE#:
 TYPE OF WORK: TRENCHING / CONDUIT

THOMAS GRID#: 1209-F6
 DRAWN FOR: SAN DIEGO



DATE: 1/22/2018
 DESIGNED: Clint Jones
 CHECKED BY: Mark Webb

SHEET 21 OF 48

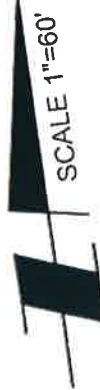

NOTE: W8-24 (STEEL PLATES AHEAD) SIGNS WILL REMAIN IN PLACE FOR DURATION OF WORK

RECEIVED
JAN 24 2018
CALTRANS-PER

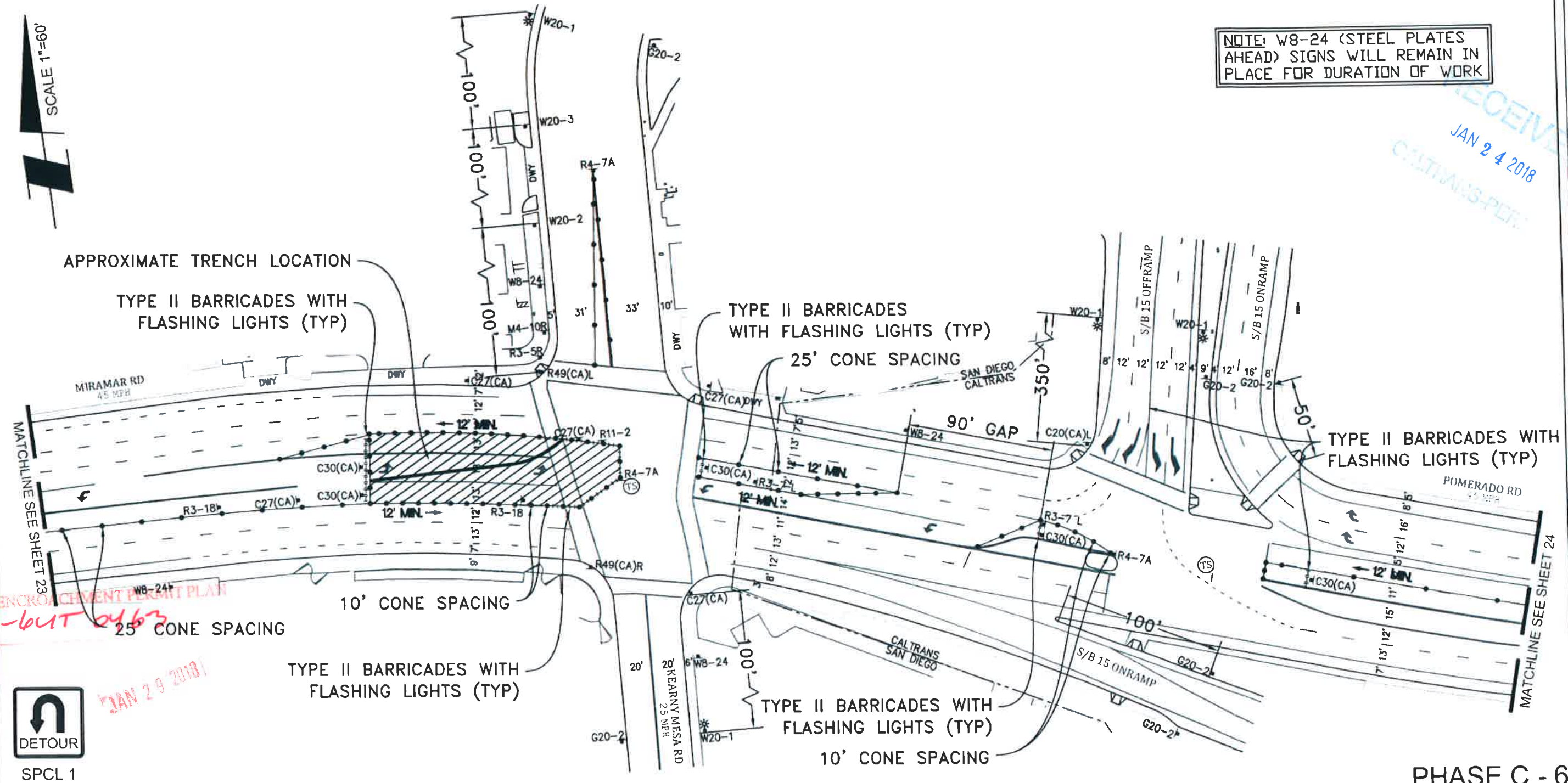

APPROVED ENCROACHMENT PERMIT PLAN
11-17-641T 0463
Permit No.:

Date: JAN 29 2018



SPCL 1

PHASE C - 6

PROJECT NAME: TL23071 - Sycamore Canyon Substation To Penasquitos Substation - 230 KV Underground

DATE: 1/22/2018
DESIGNED: Clint Jones
CHECKED BY: Mark Webb

UTILITY SURVEYORS, INC.

 2534 EAST EL NORTE PARKWAY SUITE C
 ESCONDIDO, CA 92027
 PHONE (760) 480-2347
 CELL (760) 419-3738

15092 AVENUE OF SCIENCE, SUITE 200
 SAN DIEGO, CA 92128
 P: 858 385 0500 WWW.NV5.COM

AIRX JOB#: X160218
 MISC/POTHOLE#: _____
 TYPE OF WORK: TRENCHING / CONDUIT

THOMAS GRID#: 1209-F6
 DRAWN FOR: SAN DIEGO



SHEET 22 OF 48

RECEIVED
 PERMITS-PER
 JAN 24 2018

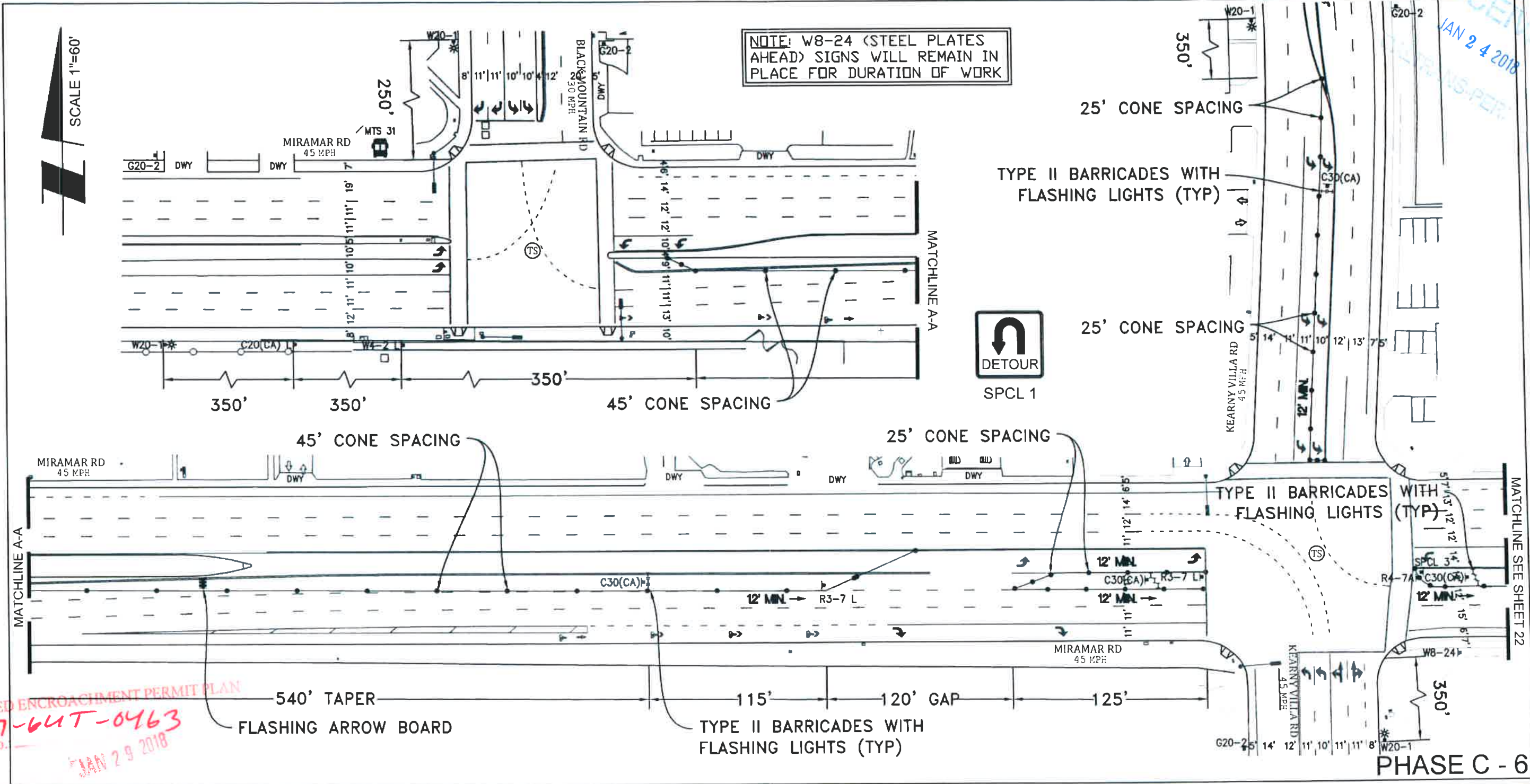

APPROVED ENCROACHMENT PERMIT PLAN
 11-17-641T-0463
 Permit No.
 JAN 29 2018

PROJECT NAME: TL23071 - Sycamore Canyon Substation To Penasquitos Substation - 230 KV Underground



DATE: 1/22/2018
 DESIGNED: Clint Jones
 CHECKED BY: Mark Webb

AIRX SURVEYORS, INC.
 Gail McMorran
 President
 2534 EAST EL NORTE PARKWAY, SUITE C
 ESCONDIDO, CA 92027
 PHONE: (760) 480-2347
 CELL: (760) 419-3738

NV5
 15092 AVENUE OF SCIENCE, SUITE 200
 SAN DIEGO, CA 92128
 P: 858.385.0500 WWW.NV5.COM

AIRX JOB#: X160218
 MISC/POTHoles#: _____
 TYPE OF WORK: TRENCHING / CONDUIT

THOMAS GRID#: 1209-F6
 DRAWN FOR: SAN DIEGO

SHEET 23 OF 48

RECEIVED
JAN 24 2018
CALTRANS-SD

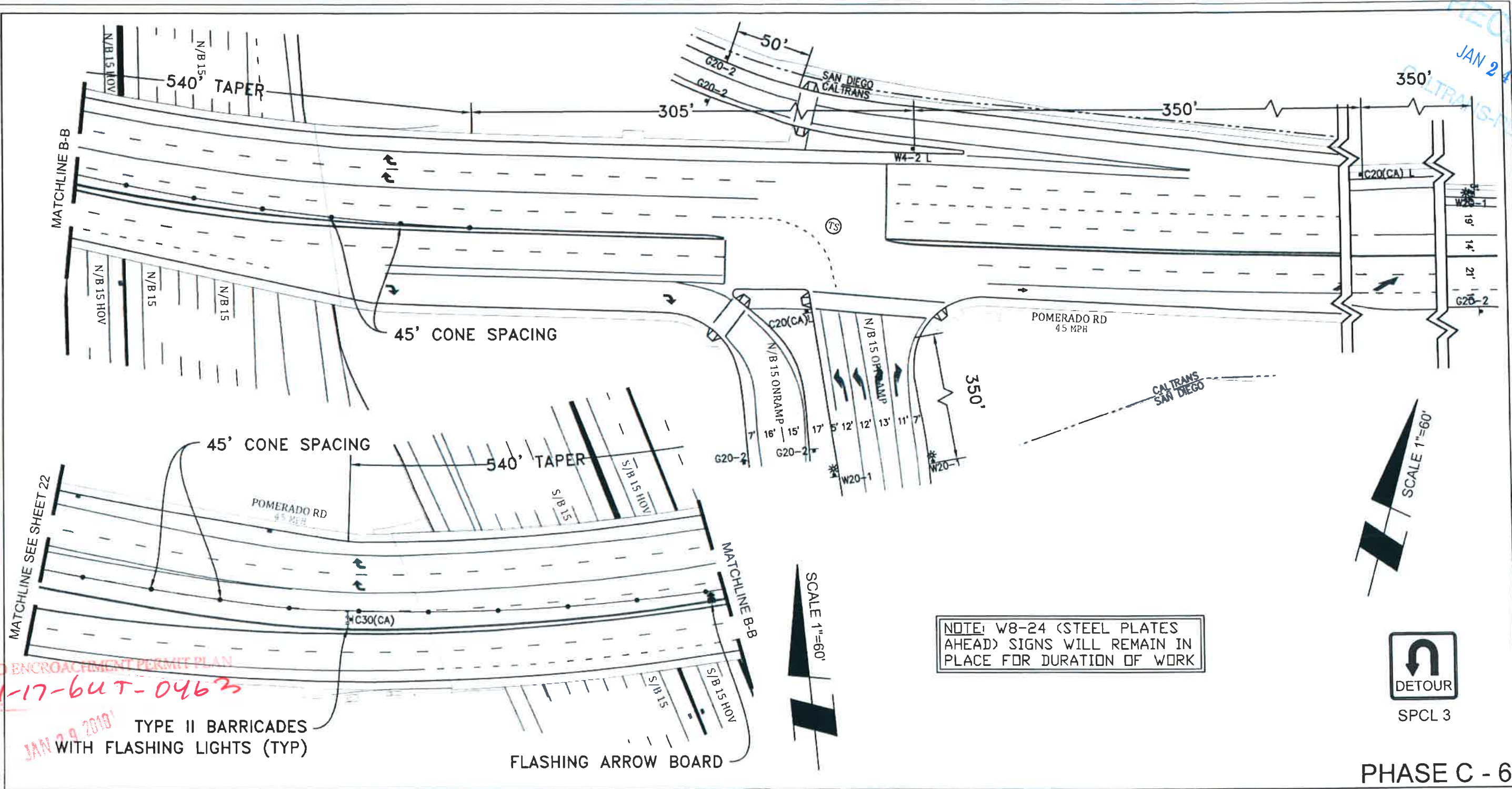

NOTE: W8-24 (STEEL PLATES AHEAD) SIGNS WILL REMAIN IN PLACE FOR DURATION OF WORK



PHASE C - 6

APPROVED ENCROACHMENT PERMIT PLAN
Permit No. 11-17-6UT-0463
Date: JAN 29 2018

PROJECT NAME: TL23071 - Sycamore Canyon Substation To Penasquitos Substation - 230 KV Underground

DATE: 1/22/2018
DESIGNED: Clint Jones
CHECKED BY: Mark Webb

UTILITY SURVEYORS, INC.
AIRX
Gail McMorran
Pres-Ident
2534 EAST EL NORTE PARKWAY SUITE C
ESCONDIDO, CA 92027
PHONE: (760) 480-2347
CELL: (760) 410-3736

N|V|5
15092 AVENUE OF SCIENCE, SUITE 200
SAN DIEGO, CA 92128
P: 858 385 0500 WWW.NV5.COM

AIRX JOB#: X160218
MISC/POTHOLES#:
TYPE OF WORK: TRENCHING / CONDUIT

THOMAS GRID#: 1209-F6
DRAWN FOR: SAN DIEGO



SHEET 24 OF 48

RECEIVED
 JAN 24 2018
 CALTRANS

SCALE 1"=60'

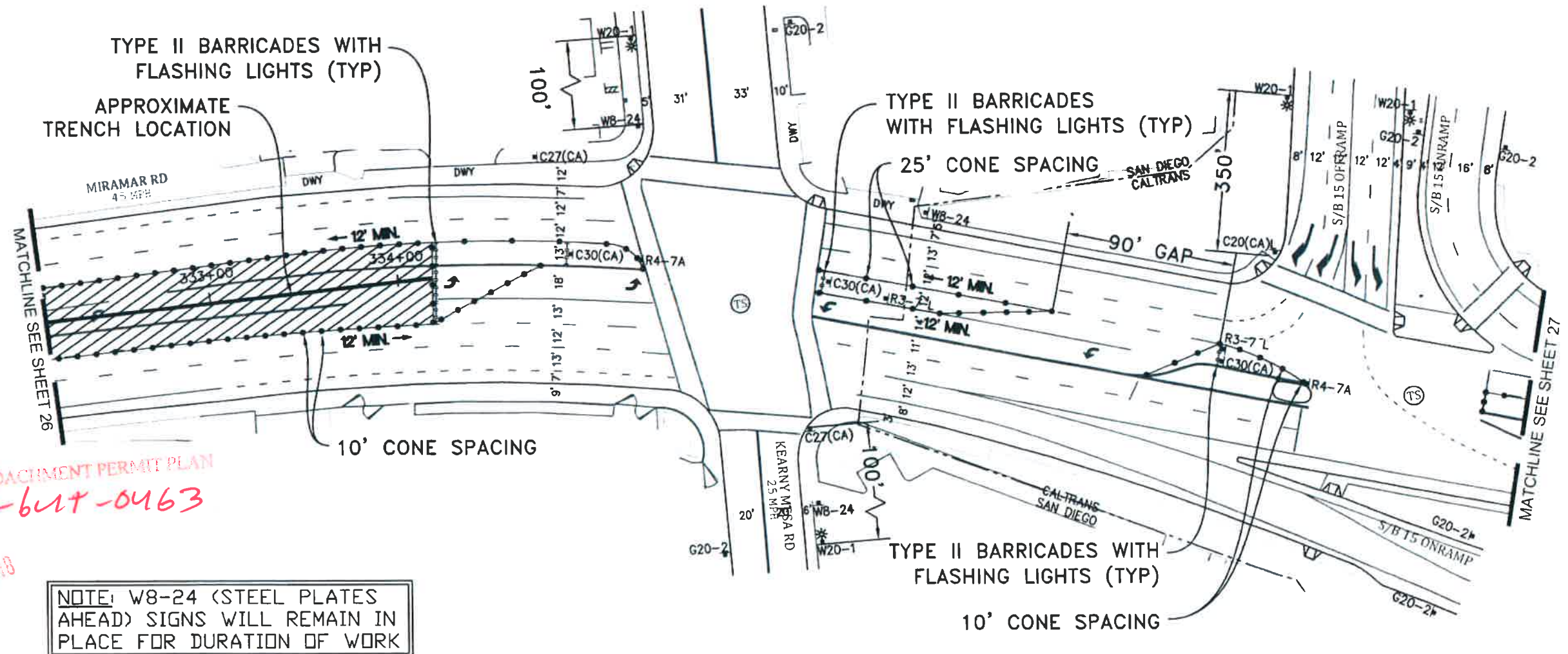

APPROVED ENCROACHMENT PERMIT PLAN
 Permit No.: 11-17-6414-0463
 DATE: JAN 29 2018

NOTE: W8-24 (STEEL PLATES AHEAD) SIGNS WILL REMAIN IN PLACE FOR DURATION OF WORK

PHASE C - 7

PROJECT NAME: TL23071 - Sycamore Canyon Substation To Penasquitos Substation - 230 KV Underground

UTILITY SURVEYORS, INC.
AIRX
 Gail McMorran
 President
 2534 EAST EL NORTE PARKWAY SUITE C
 ESCONDIDO, CA 92027
 PHONE (760) 460-2347
 CELL (760) 419-3738

NV5
 15092 AVENUE OF SCIENCE, SUITE 200
 SAN DIEGO, CA 92128
 P: 858 385 0500 WWW.NV5.COM

AIRX JOB#: X160218
 MISC/POTHOLE#:
 TYPE OF WORK: TRENCHING / CONDUIT

THOMAS GRID#: 1209-F6
 DRAWN FOR: CALTRANS



DATE: 1/22/2018
 DESIGNED: Clint Jones
 CHECKED BY: Mark Webb

SHEET 25 OF 48

SCALE 1"=60'

NOTE: W8-24 (STEEL PLATES AHEAD) SIGNS WILL REMAIN IN PLACE FOR DURATION OF WORK

RECEIVED
JAN 24 2018
CALTRANS-PET

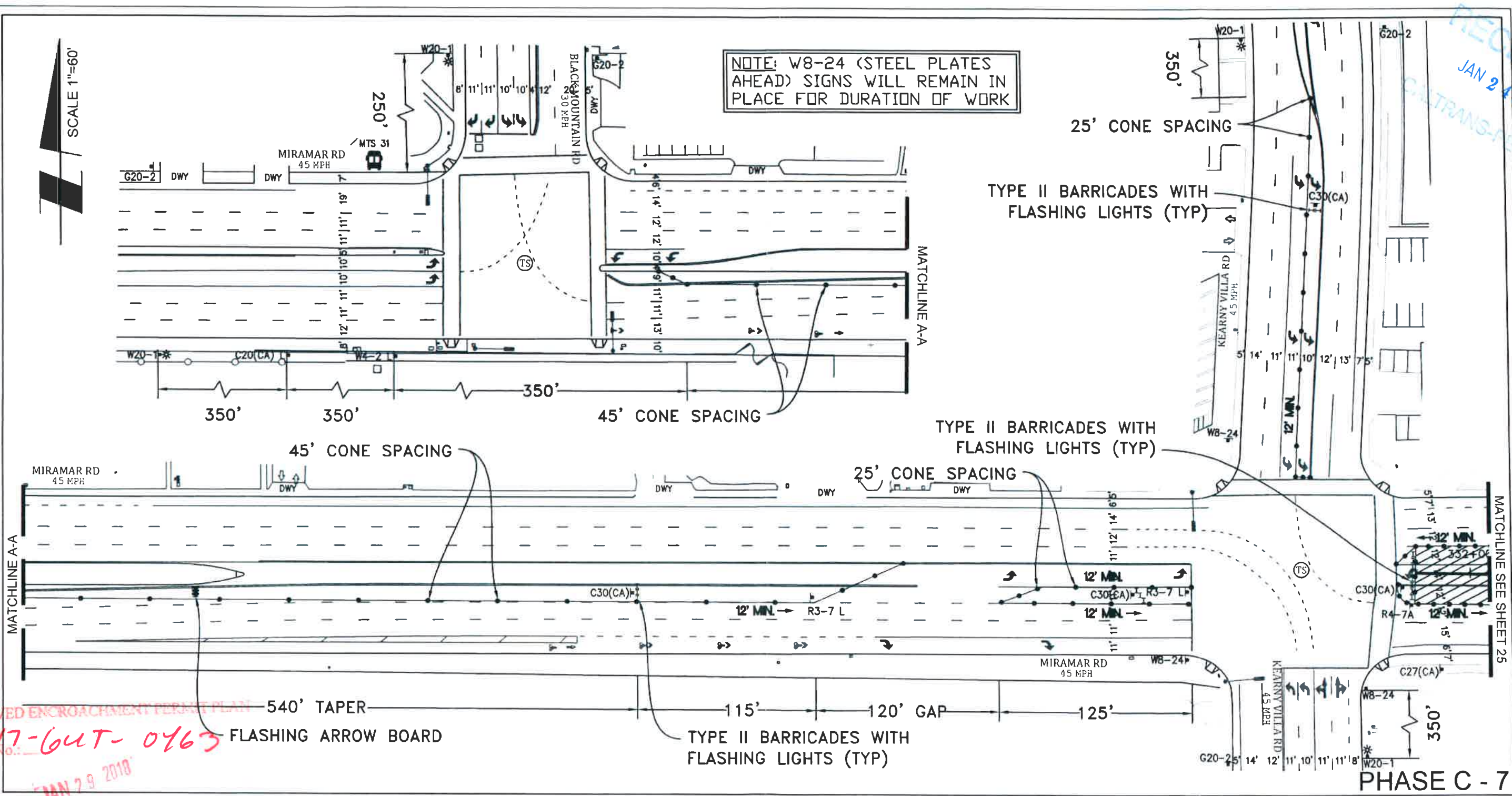

APPROVED ENCROACHMENT PERMIT PLAN
11-17-64T-0463
Permit No.:
Date: JAN 29 2018

PHASE C - 7

PROJECT NAME: TL23071 - Sycamore Canyon Substation To Penasquitos Substation - 230 KV Underground

UTILITY SURVEYORS, INC.
AIRX
Gail McMorran
President
2534 EAST EL NORTE PARKWAY SUITE C
ESCONDIDO, CA 92027
PHONE: (760) 480-2347
CELL: (760) 419-3738

NV5
15092 AVENUE OF SCIENCE, SUITE 200
SAN DIEGO, CA 92128
P: 858 385 0500 WWW.NV5.COM

AIRX JOB#: X160218
MISC/POTHOLE#: _____
TYPE OF WORK: TRENCHING / CONDUIT

THOMAS GRID#: 1209-F
DRAWN FOR: CALTRANS



DATE: 1/22/2018
DESIGNED: Clint Jones
CHECKED BY: Mark Webb

SHEET 26 OF 48

RECEIVED
JAN 24 2018
CALTRANS-PER

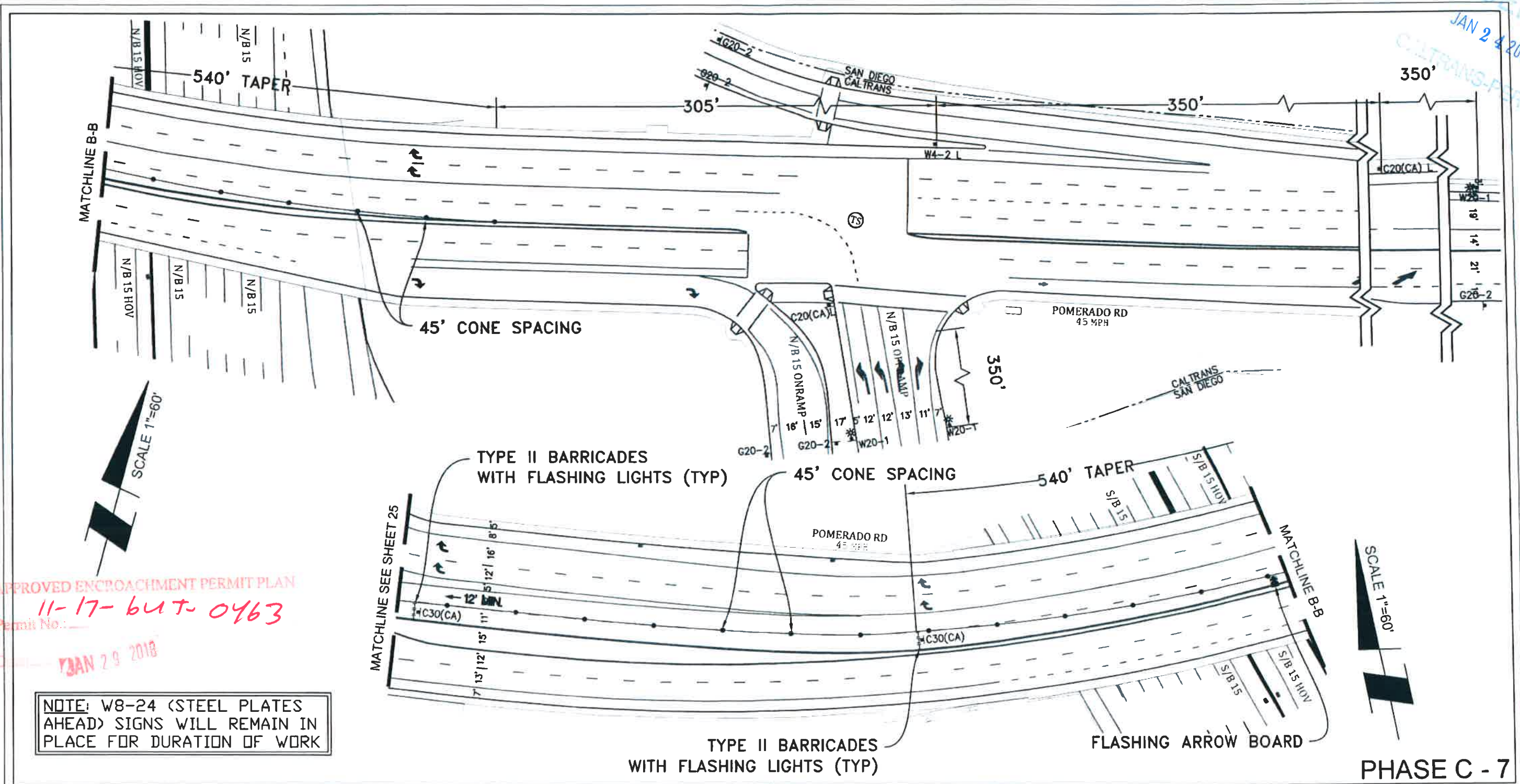

APPROVED ENCROACHMENT PERMIT PLAN
Permit No.: 11-17-but-0463
JAN 29 2018

NOTE: W8-24 (STEEL PLATES AHEAD) SIGNS WILL REMAIN IN PLACE FOR DURATION OF WORK

PHASE C - 7

PROJECT NAME: TL23071 - Sycamore Canyon Substation To Penasquitos Substation - 230 KV Underground

UTILITY SURVEYORS, INC.
AIRX
Gail McMorran
President
2534 EAST EL NORTE PARKWAY SUITE C
ESCONDIDO, CA 92027
PHONE: (760) 480-2347
CELL: (760) 419-3738

NV5
15092 AVENUE OF SCIENCE, SUITE 200
SAN DIEGO, CA 92128
P: 858.385.0500 WWW.NV5.COM

AIRX JOB#: X160218
MISC/POTHOLES#:
TYPE OF WORK: TRENCHING / CONDUIT

THOMAS GRID#: 1209-F6
DRAWN FOR: CALTRANS



DATE: 1/22/2018
DESIGNED: Clint Jones
CHECKED BY: Mark Webb

SHEET 27 OF 48

RECEIVED
JAN 24 2018
CALTRANS

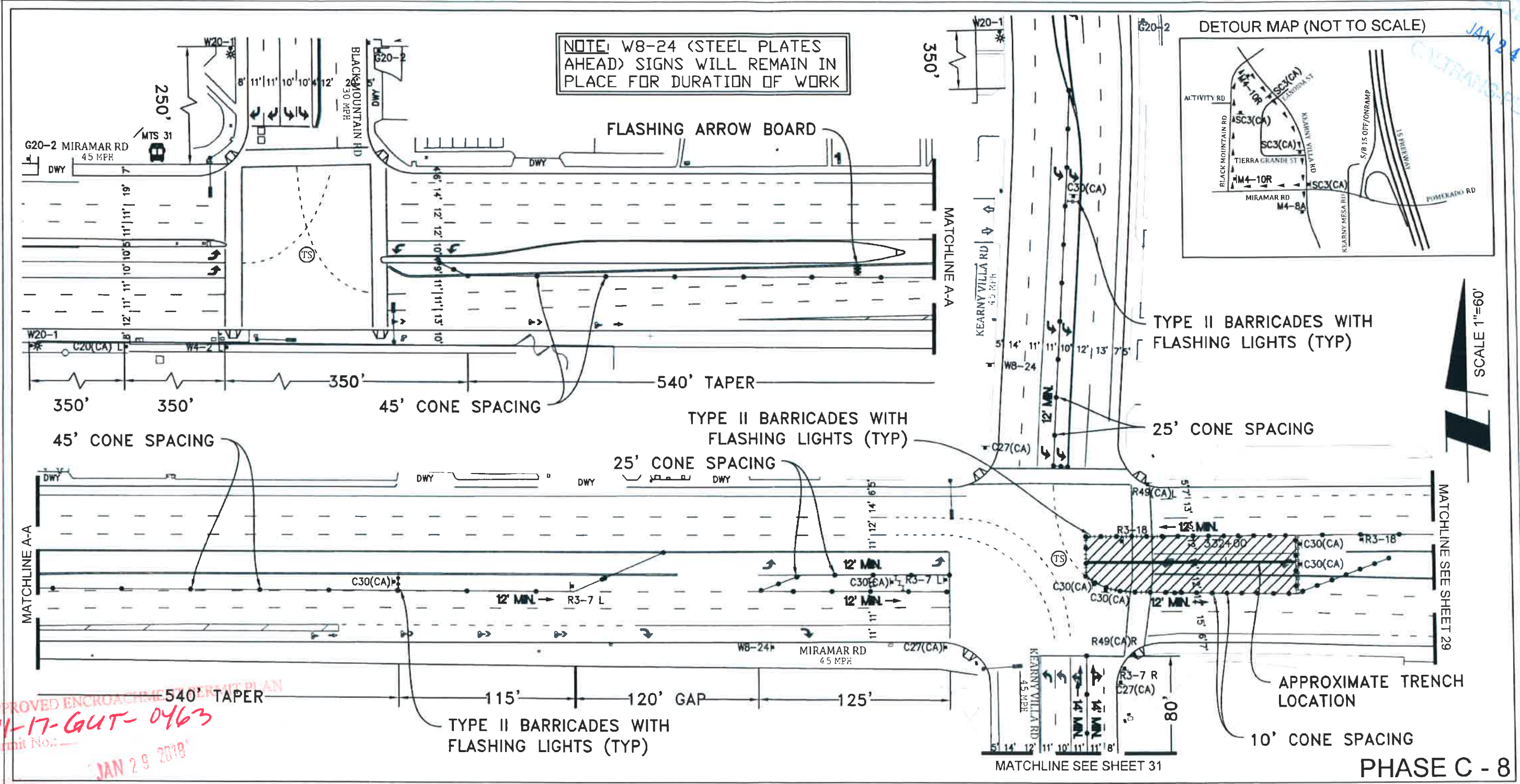

APPROVED ENCROACHMENT PERMIT PLAN
11-17-GUT-0463
Permit No.:
JAN 29 2018

PROJECT NAME: TL23071 – Sycamore Canyon Substation To Penasquitos Substation – 230 KV Underground

DATE: 1/22/2018
DESIGNED: Clint Jones
CHECKED BY: Mark Webb

UTILITY SURVEYORS, INC.
AIRX
Gail McMorrان
President
2534 EAST EL NORTE PARKWAY SUITE C
ESCONDIDO, CA 92027
PHONE: (760) 480-2347
CELL: (760) 419-3738

N|V|5
15092 AVENUE OF SCIENCE, SUITE 200
SAN DIEGO, CA 92128
P: 858.385.0500 WWW.NV5.COM

AIRX JOB#: X160218
MISC/POTHOLE#: _____
THOMAS GRID#: 1209-F6
DRAWN FOR: CALTRANS
TYPE OF WORK: TRENCHING / CONDUIT



SHEET 28 OF 48

RECEIVED
 JAN 24 2018
 CALTRANS-PERMIT

SCALE 1"=60'

TYPE II BARRICADES WITH FLASHING LIGHTS (TYP)
 25' CONE SPACING

TYPE II BARRICADES WITH FLASHING LIGHTS (TYP)
 25' CONE SPACING

TYPE II BARRICADES WITH FLASHING LIGHTS (TYP)
 10' CONE SPACING

NOTE: W8-24 (STEEL PLATES AHEAD) SIGNS WILL REMAIN IN PLACE FOR DURATION OF WORK

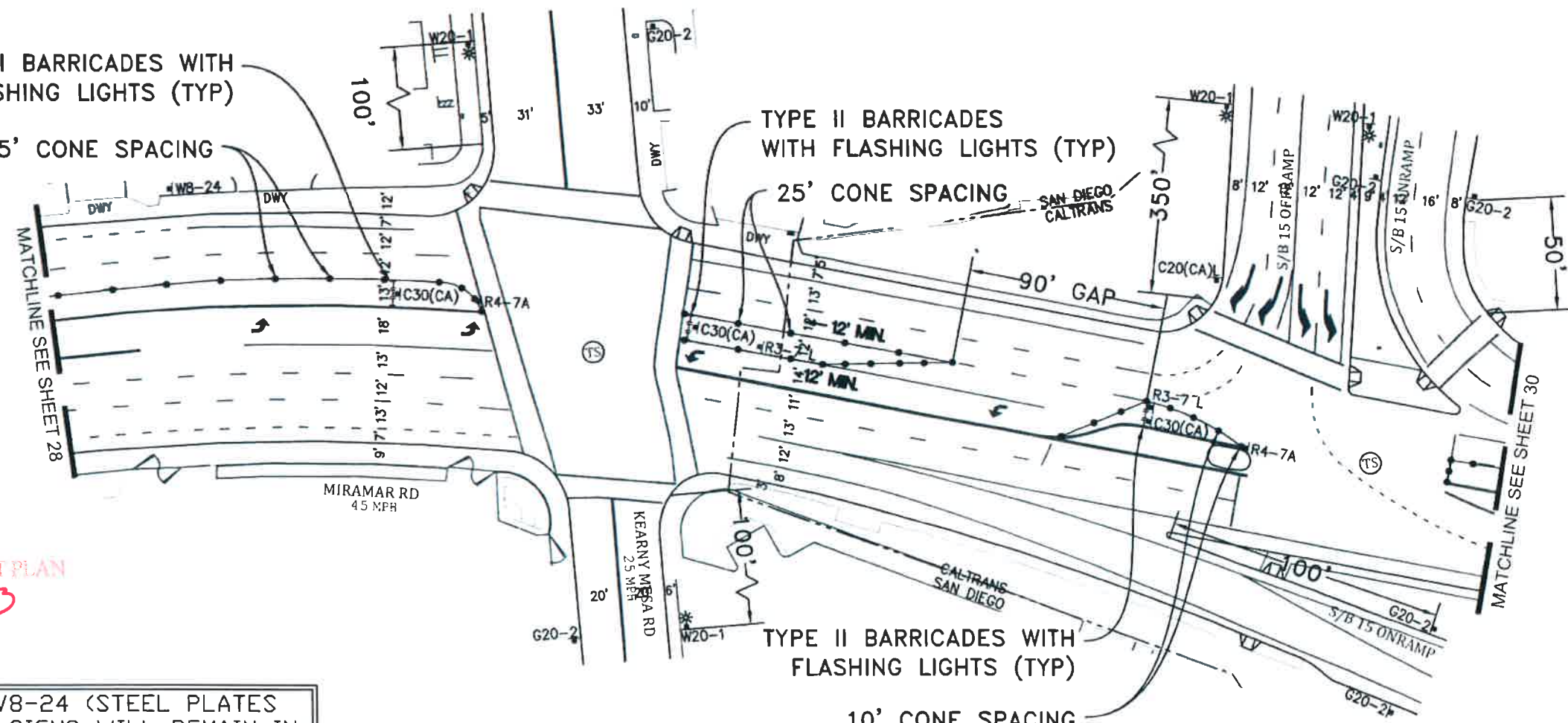

APPROVED ENCROACHMENT PERMIT PLAN
 11-17-647-0163
 Permit No.:
 Date: JAN 29 2018

PHASE C - 8

PROJECT NAME: TL23071 - Sycamore Canyon Substation To Penasquitos Substation - 230 KV Underground

DATE: 1/22/2018
 DESIGNED: Clint Jones
 CHECKED BY: Mark Webb

UTILITY SURVEYORS, INC
AIRX
 Gail McMorran
 President
 2534 EAST EL NORTE PARKWAY SUITE C
 ESCONDIDO, CA 92027
 PHONE (760) 480-2347
 CELL (760) 419-3738

N|V|5
 15092 AVENUE OF SCIENCE, SUITE 200
 SAN DIEGO, CA 92128
 P: 858.385.0500 WWW.NV5.COM

AIRX JOB#: X160218
 THOMAS GRID#: 1209-F6
 MISC/POTHOLE#: DRAWN FOR: CALTRANS
 TYPE OF WORK: TRENCHING / CONDUIT

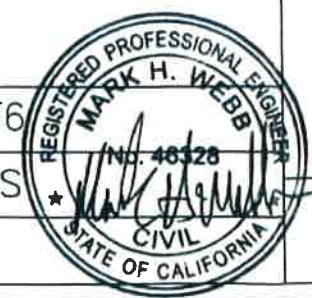

SHEET 29 OF 48

RECEIVED
 JAN 24 2018
 CALTRANS-PER

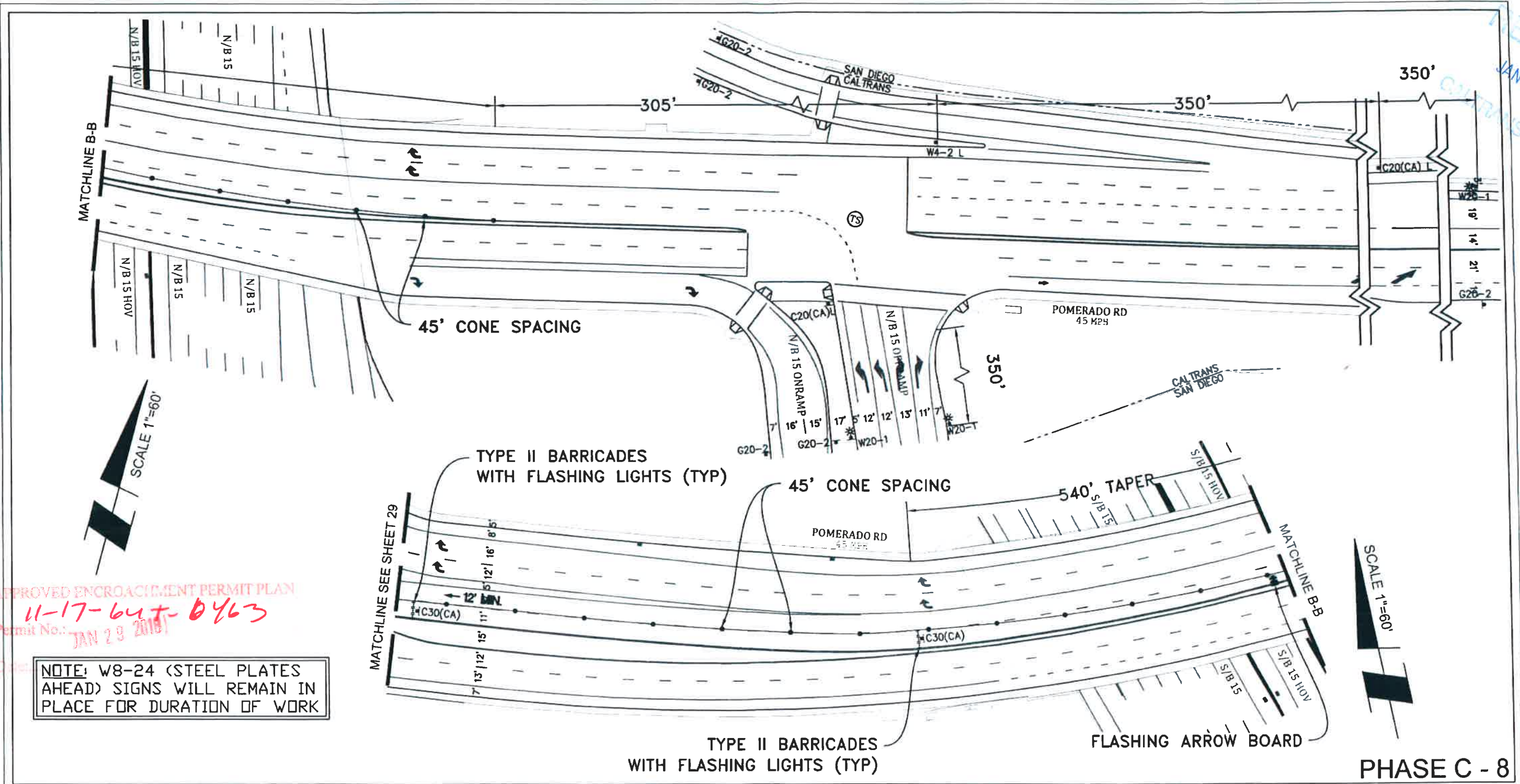

APPROVED ENCROACHMENT PERMIT PLAN
 11-17-647-0463
 Permit No.: JAN 23 2018

NOTE: W8-24 (STEEL PLATES AHEAD) SIGNS WILL REMAIN IN PLACE FOR DURATION OF WORK

PHASE C - 8

PROJECT NAME: TL23071 - Sycamore Canyon Substation To Penasquitos Substation - 230 KV Underground

UTILITY SURVEYORS, INC.
AIRX
 Gail McMorran
 President
 7534 EAST EL NORTE PARKWAY SUITE C
 ESCONDIDO, CA 92027
 PHONE (760) 480-2347
 CELL (760) 419-3738

N|V|5
 15092 AVENUE OF SCIENCE, SUITE 200
 SAN DIEGO, CA 92128
 P: 858.385.0500 WWW.NV5.COM

AIRX JOB#: X160218
 MISC/POTHOLE#:
 TYPE OF WORK: TRENCHING / CONDUIT

THOMAS GRID#: 1209-F
 DRAWN FOR: CALTRANS



DATE: 1/22/2018
 DESIGNED: Clint Jones
 CHECKED BY: Mark Webb

SHEET 30 OF 48

RECEIVED
 JAN 24 2018
 CALTRANS-PER

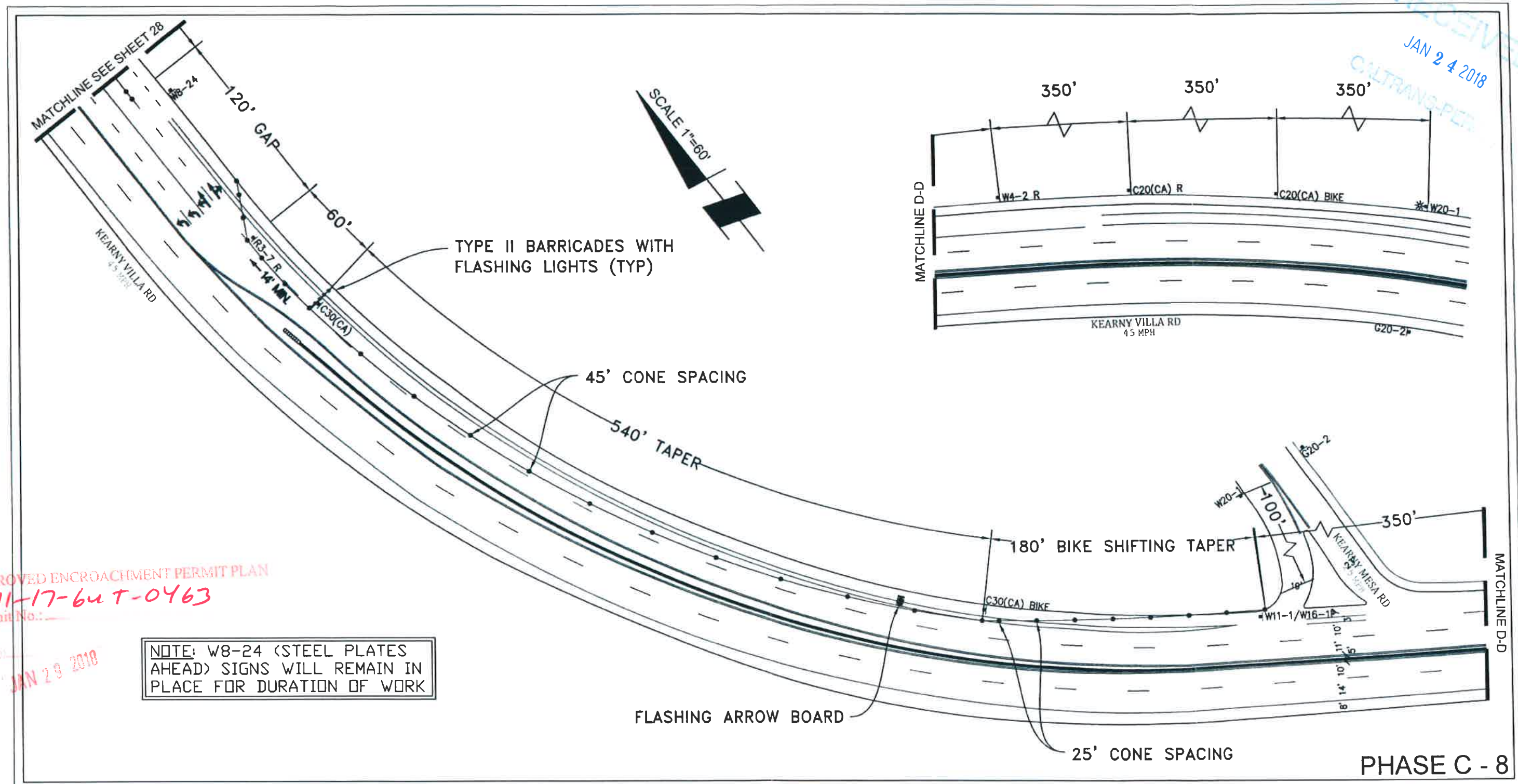

APPROVED ENCROACHMENT PERMIT PLAN
 11-17-64 T-0463
 Permit No.:

Date: JAN 29 2018

NOTE: W8-24 (STEEL PLATES AHEAD) SIGNS WILL REMAIN IN PLACE FOR DURATION OF WORK

PROJECT NAME: TL23071 - Sycamore Canyon Substation To Penasquitos Substation - 230 KV Underground

UTILITY SURVEYORS, INC.
AIRX
 Gail McMorran
 President
 2534 EAST EL NORTE PARKWAY SUITE C
 ESCONDIDO, CA 92027
 PHONE (760) 480-2347
 CELL (760) 419-3738

NV5
 15092 AVENUE OF SCIENCE, SUITE 200
 SAN DIEGO, CA 92128
 P: 858 385.0500 WWW.NV5.COM

AIRX JOB#: X160218
 MISC/POTHOLE#:
 TYPE OF WORK: TRENCHING / CONDUIT

THOMAS GRID#: 1209-F6
 DRAWN FOR: CALTRANS



DATE: 1/22/2018
 DESIGNED: Clint Jones
 CHECKED BY: Mark Webb

SHEET 31 OF 48

RECEIVED
CALTRANS-PE
JAN 24 2018

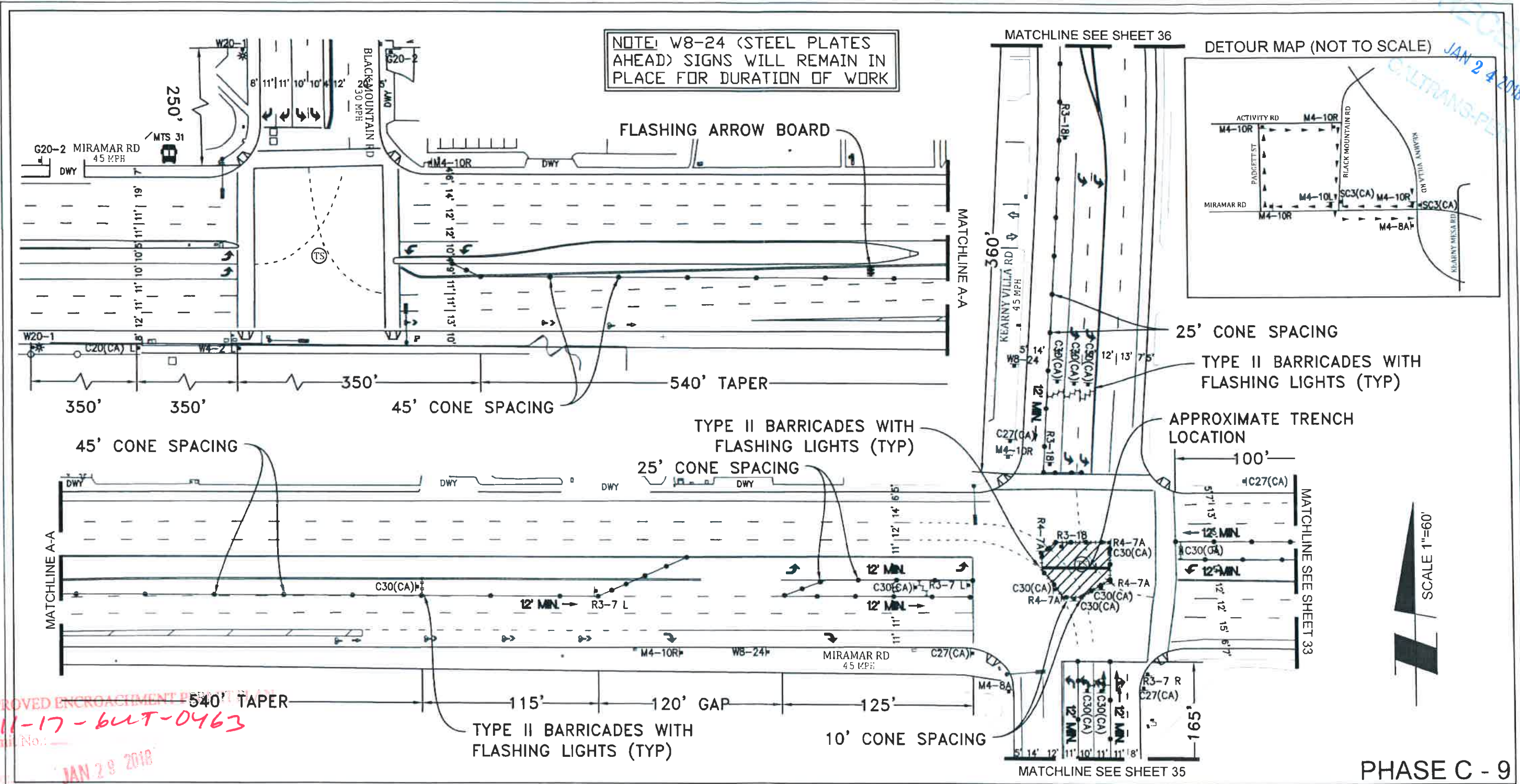

NOTE: W8-24 (STEEL PLATES AHEAD) SIGNS WILL REMAIN IN PLACE FOR DURATION OF WORK

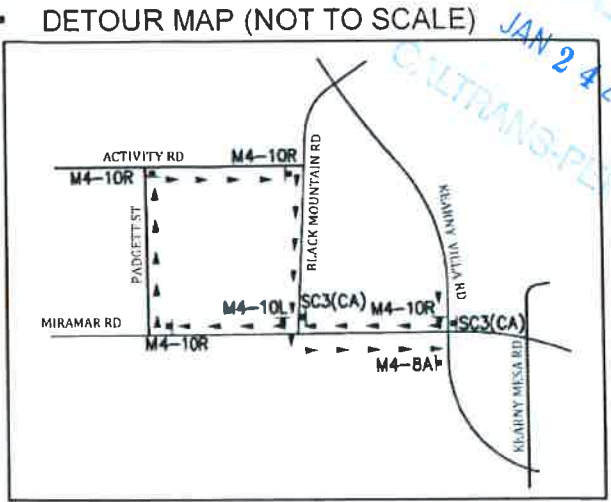

APPROVED ENCROACHMENT PERMIT
11-17-64T-0463
Permit No.:
Date: JAN 29 2018

PROJECT NAME: TL23071 - Sycamore Canyon Substation To Penasquitos Substation - 230 KV Underground

DATE: 1/22/2018
DESIGNED: Clint Jones
CHECKED BY: Mark Webb

UTILITY SURVEYORS, INC.
AIRX
Gail McMorran
President
2534 EAST EL NORTE PARKWAY SUITE C
ESCONDIDO, CA 92027
PHONE (760) 480-2347
CELL (760) 419-3738

N|V|5
15092 AVENUE OF SCIENCE, SUITE 200
SAN DIEGO, CA 92128
P: 858 385 0500 WWW.NV5.COM

AIRX JOB#: X160218
MISC/POTHoles#:
TYPE OF WORK: TRENCHING / CONDUIT

THOMAS GRID#: 1209-F6
DRAWN FOR: CALTRANS

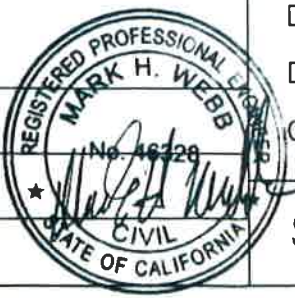

SHEET 32 OF 48

PHASE C - 9

RECEIVED
 JAN 24 2018
 CALTRANS-PER

SCALE 1"=60'

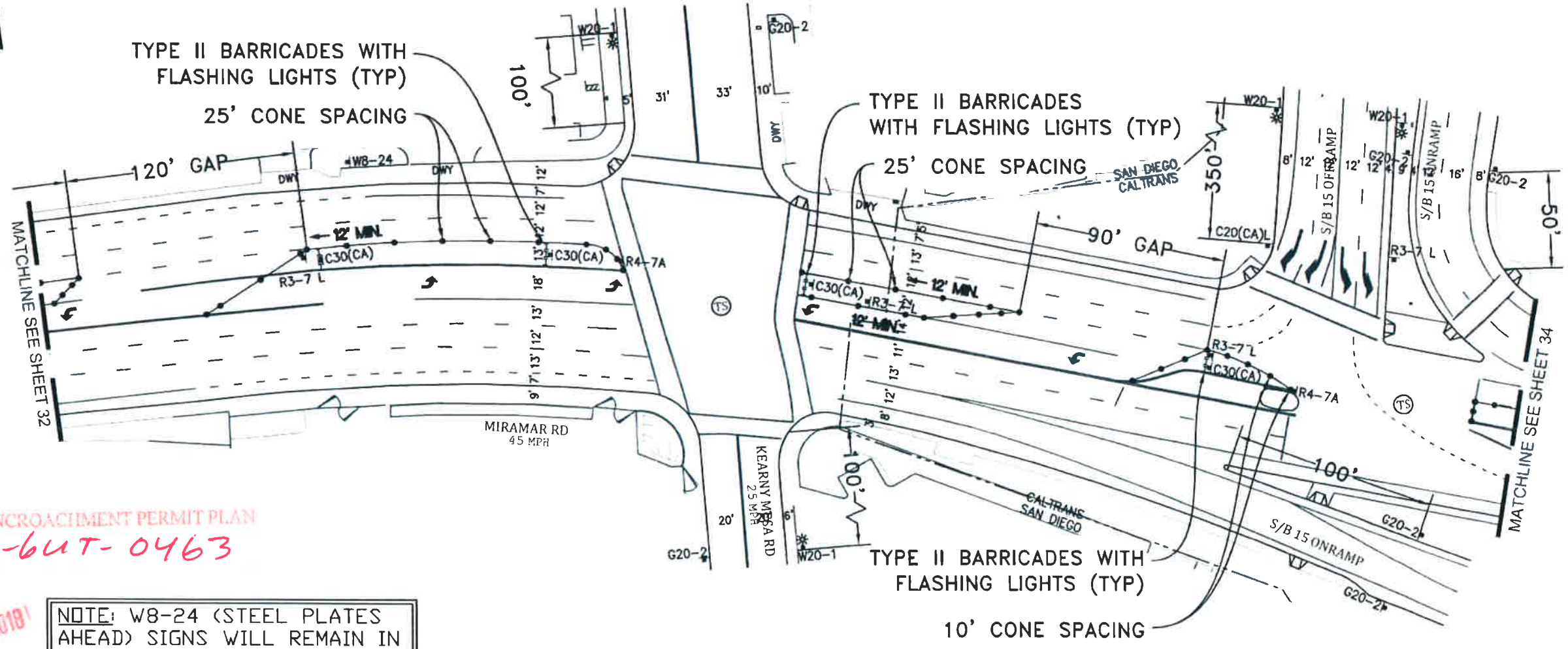

APPROVED ENCROACHMENT PERMIT PLAN
 11-17-6UT-0463
 Permit No.:

Date: JAN 29 2018

NOTE: W8-24 (STEEL PLATES AHEAD) SIGNS WILL REMAIN IN PLACE FOR DURATION OF WORK

PHASE C - 9

PROJECT NAME: TL23071 - Sycamore Canyon Substation To Penasquitos Substation - 230 KV Underground

DATE: 1/22/2018
 DESIGNED: Clint Jones
 CHECKED BY: Mark Webb

UTILITY SURVEYORS, INC.
AIRX
 Gail McMorran
 President
 2534 EAST EL NORTE PARKWAY SUITE C
 ESCONDIDO, CA 92027
 PHONE: (760) 480-2347
 CELL: (760) 419-3738

N|V|5
 15092 AVENUE OF SCIENCE, SUITE 200
 SAN DIEGO, CA 92128
 P: 858.385.0500 WWW.NV5.COM

AIRX JOB#: X160218
 MISC/POTHOLE#:
 TYPE OF WORK: TRENCHING / CONDUIT

THOMAS GRID#: 1209-F6
 DRAWN FOR: CALTRANS



SHEET 33 OF 48

RECEIVED
 JAN 24 2018
 CALTRANS-PERMIT

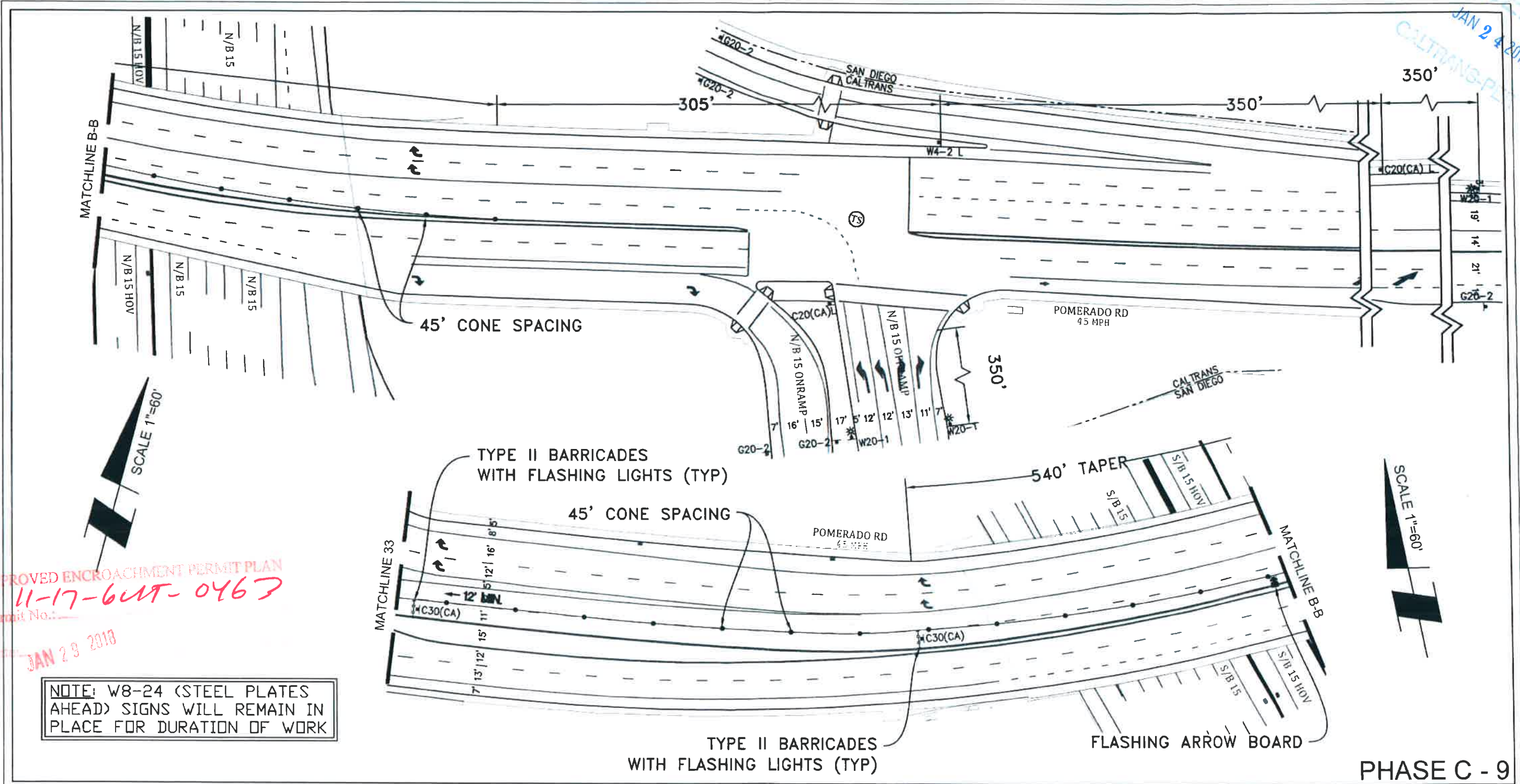

APPROVED ENCROACHMENT PERMIT PLAN
 11-17-644T-0463
 Permit No.:
 Date: JAN 29 2018

NOTE: W8-24 (STEEL PLATES AHEAD) SIGNS WILL REMAIN IN PLACE FOR DURATION OF WORK

PHASE C - 9

PROJECT NAME: TL23071 - Sycamore Canyon Substation To Penasquitos Substation - 230 KV Underground

DATE: 1/22/2018
 DESIGNED: Clint Jones
 CHECKED BY: Mark Webb

UTILITY SURVEYORS, INC.
AIRX
 Gail McMorran
 President
 2534 EAST EL NORTE PARKWAY, SUITE C
 ESCONDIDO, CA 92027
 PHONE: (760) 480-2347
 CELL: (760) 419-3738

N|V|5
 15092 AVENUE OF SCIENCE, SUITE 200
 SAN DIEGO, CA 92128
 P: 858.385.0500 WWW.NV5.COM

AIRX JOB#: X160218	THOMAS GRID#: 1209-F6
MISC/POTHOLE#:	DRAWN FOR: CALTRANS
TYPE OF WORK: TRENCHING / CONDUIT	



SHEET 34 OF 48

RECEIVED
 JAN 24 2018
 CALTRANS-P&T

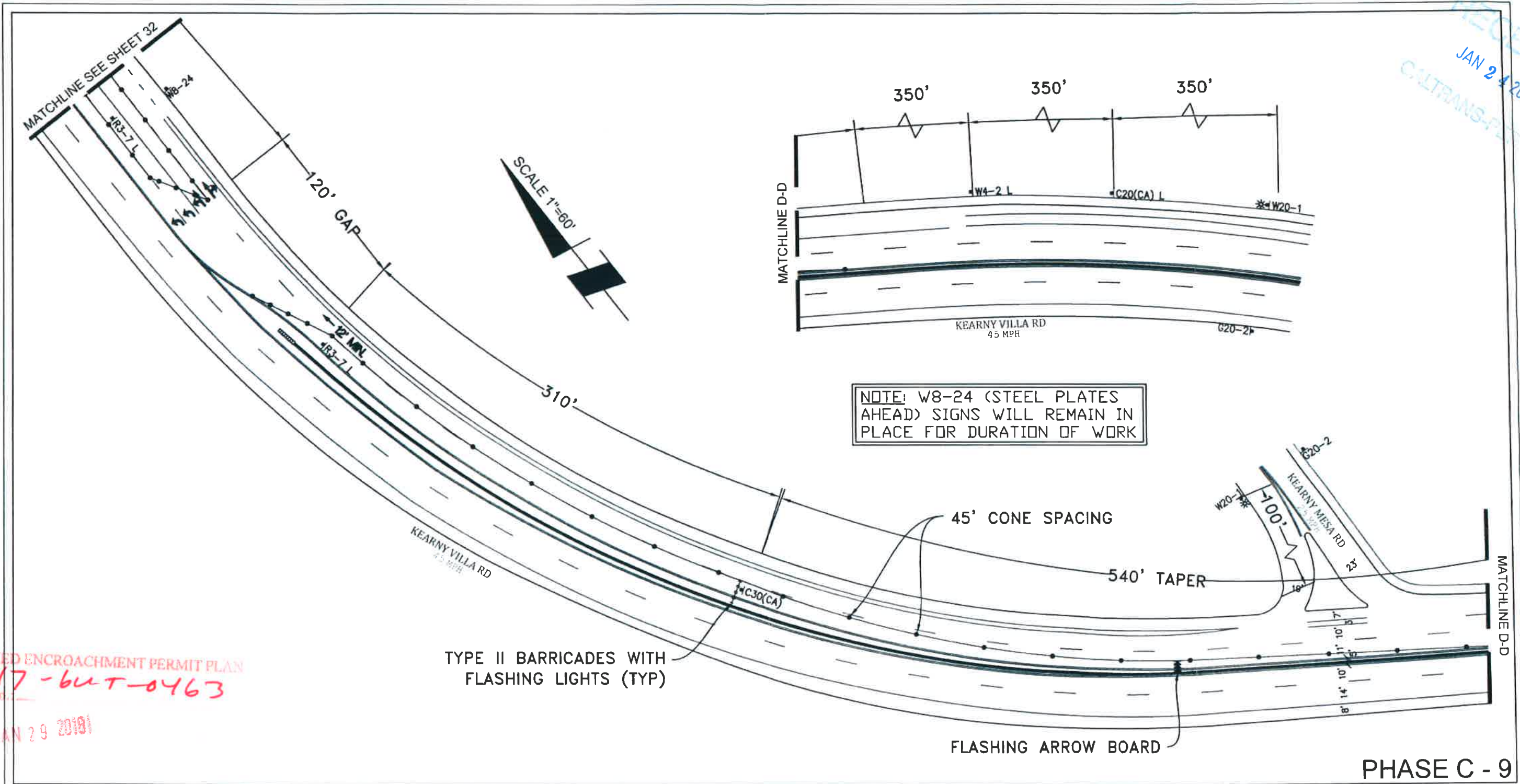

APPROVED ENCROACHMENT PERMIT PLAN
 11-17-BUT-0463
 Permit No. _____
 Date: JAN 29 2018

PHASE C - 9

PROJECT NAME: TL23071 - Sycamore Canyon Substation To
 Penasquitos Substation - 230 KV Underground

UTILITY SURVEYORS, INC.
AIRX
 Gail McMorran
 President
 2534 EAST EL NORTE PARKWAY SUITE C
 ESCONDIDO, CA 92027
 PHONE: (760) 480-2347
 CELL: (760) 419-3738

N|V|5
 15092 AVENUE OF SCIENCE, SUITE 200
 SAN DIEGO, CA 92128
 P: 858.385.0500 WWW.NV5.COM

AIRX JOB#: X160218
 MISC/POTHOLES#:
 TYPE OF WORK: TRENCHING / CONDUIT

THOMAS GRID#: 1209-F6
 DRAWN FOR: CALTRANS



DATE: 1/22/2018
 DESIGNED: Clint Jones
 CHECKED BY: Mark Webb

SHEET 35 OF 48

RECEIVED
 JAN 24 2018
 CALTRANS-PER

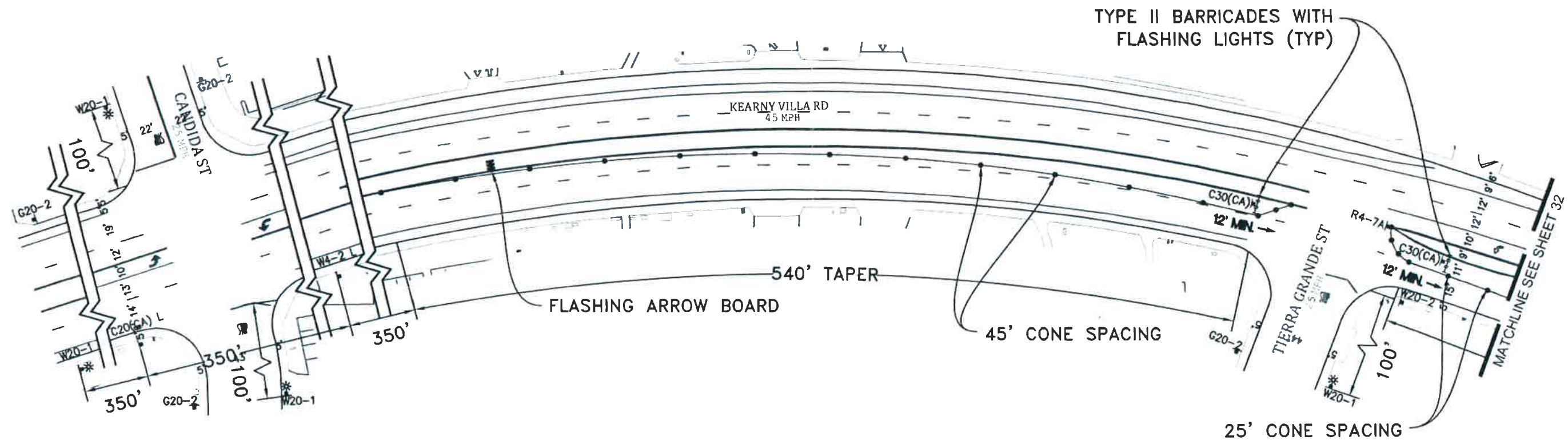
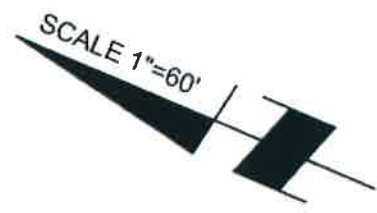

NOTE: W8-24 (STEEL PLATES AHEAD) SIGNS WILL REMAIN IN PLACE FOR DURATION OF WORK

APPROVED ENCROACHMENT PERMIT PLAN
 11-17-64T-0463
 Permit No.:
 JAN 29 2018

PHASE C - 9

PROJECT NAME: TL23071 - Sycamore Canyon Substation To Penasquitos Substation - 230 KV Underground

DATE: 1/22/2018
 DESIGNED: Clint Jones
 CHECKED BY: Mark Webb

UTILITY SURVEYORS, INC.
AIRX
 Gail McMorran
 President
 2534 EAST EL NORTE PARKWAY SUITE C
 ESCONDIDO CA 92027
 PHONE (760) 480-2347
 CELL (760) 419-3738

N|V5
 15092 AVENUE OF SCIENCE, SUITE 200
 SAN DIEGO, CA 92128
 P: 858.385.0500 WWW.NV5.COM

AIRX JOB#: X160218
 THOMAS GRID#: 1209-F6
 MISC/POTHOLE#: DRAWN FOR: CALTRANS
 TYPE OF WORK: TRENCHING / CONDUIT



SHEET 36 OF 48

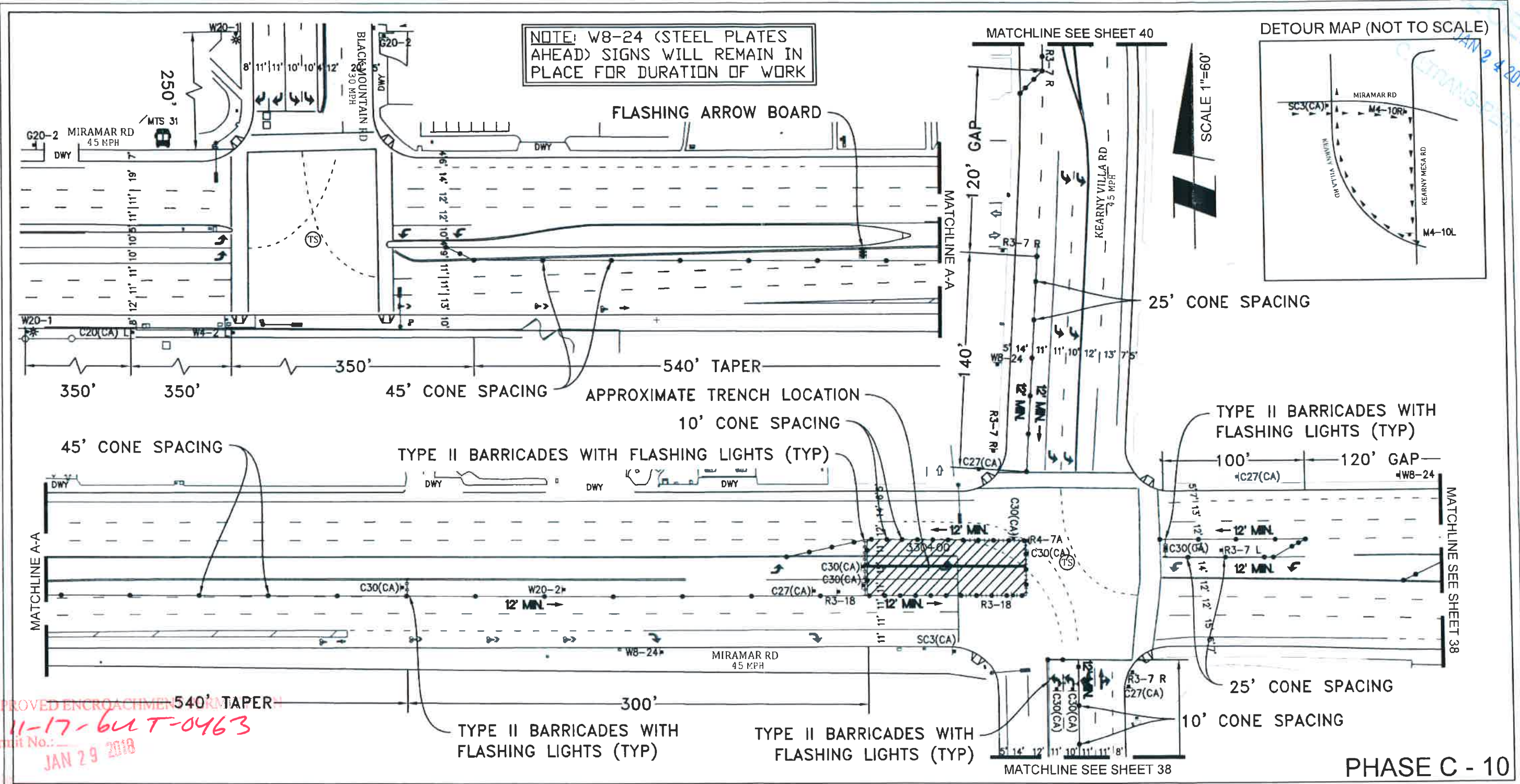

APPROVED ENCROACHMENT PERMIT
 11-17-64 T-0463
 Permit No.:
 JAN 29 2018

PROJECT NAME: TL23071 – Sycamore Canyon Substation To Penasquitos Substation – 230 KV Underground

DATE: 1/22/2018
 DESIGNED: Clint Jones
 CHECKED BY: Mark Webb

UTILITY SURVEYORS, INC.
AIRX
 Gail McMorran
 President
 2534 EAST EL NORTE PARKWAY SUITE C
 ESCONDIDO, CA 92027
 PHONE: (760) 480-2347
 CELL: (760) 419-3738

NV5
 15092 AVENUE OF SCIENCE, SUITE 200
 SAN DIEGO, CA 92128
 P: 858 385 0500 WWW.NV5.COM

AIRX JOB#: X160218
 MISC/POTHOLES#:
 TYPE OF WORK: TRENCHING / CONDUIT

THOMAS GRID#: 1209-F6
 DRAWN FOR: CALTRANS



SHEET 37 OF 48

PHASE C - 10

RECEIVED
JAN 24 2018
CALTRANS-PE

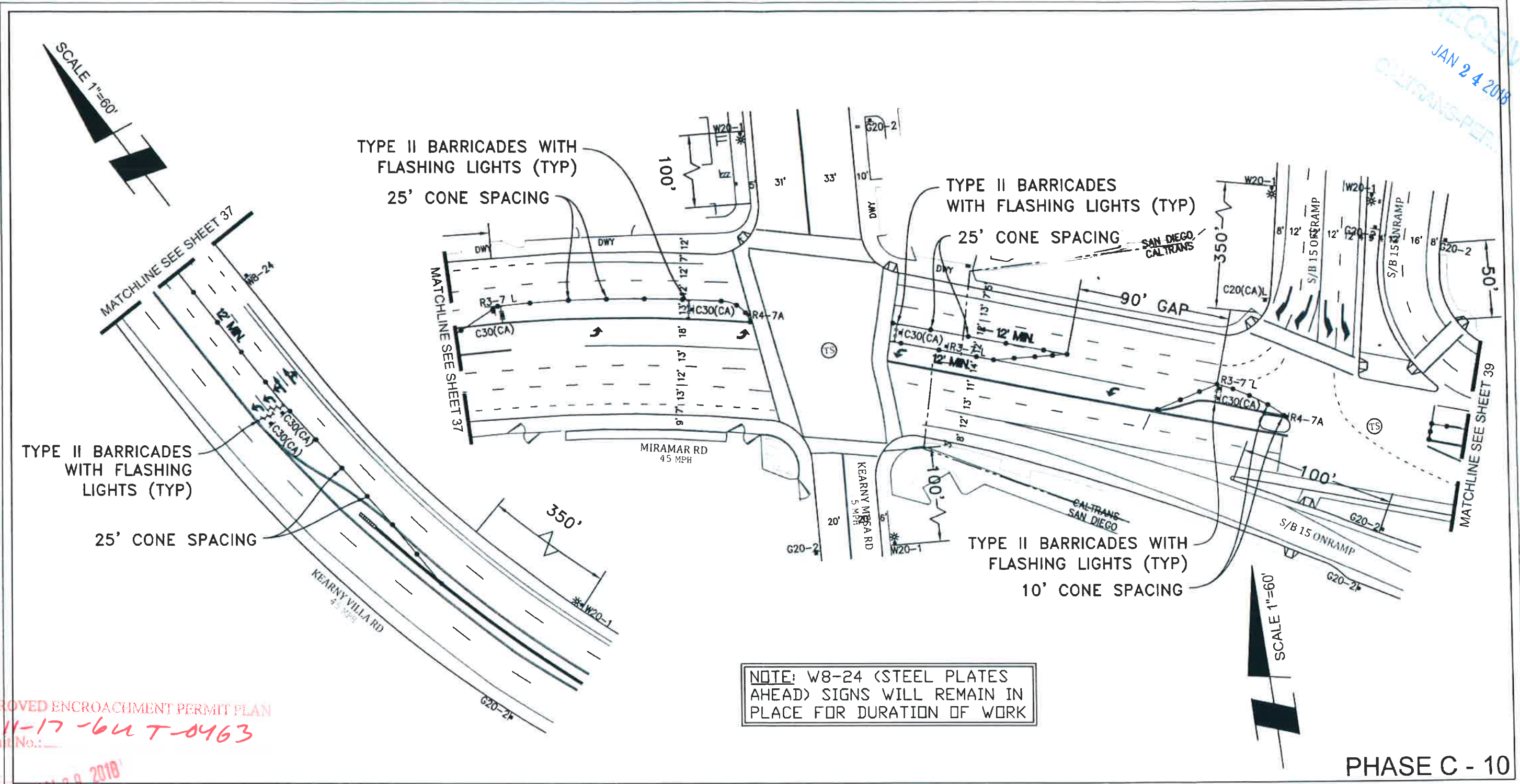

APPROVED ENCROACHMENT PERMIT PLAN
11-17-64 T-0463
Permit No.:
JAN 29 2018

PHASE C - 10

PROJECT NAME: TL23071 – Sycamore Canyon Substation To
Penasquitos Substation – 230 KV Underground

DATE: 1/22/2018
DESIGNED: Clint Jones
CHECKED BY: Mark Webb

UTILITY SURVEYORS, INC.
AIRX
Gail McMorran
President
25M EAST EL NORTE PARKWAY SUITE C
ESCONDIDO, CA 92027
PHONE (760) 480-2347
CELL: (760) 419-3738

NV5
15092 AVENUE OF SCIENCE, SUITE 200
SAN DIEGO, CA 92128
P: 858.385.0500 WWW.NV5.COM

AIRX JOB#: X160218
MISC/POTHOLES#:
TYPE OF WORK: TRENCHING / CONDUIT

THOMAS GRID#: 1209-F6
DRAWN FOR: CALTRANS



SHEET 38 OF 48

RECEIVED
 JAN 24 2018
 CALTRANS

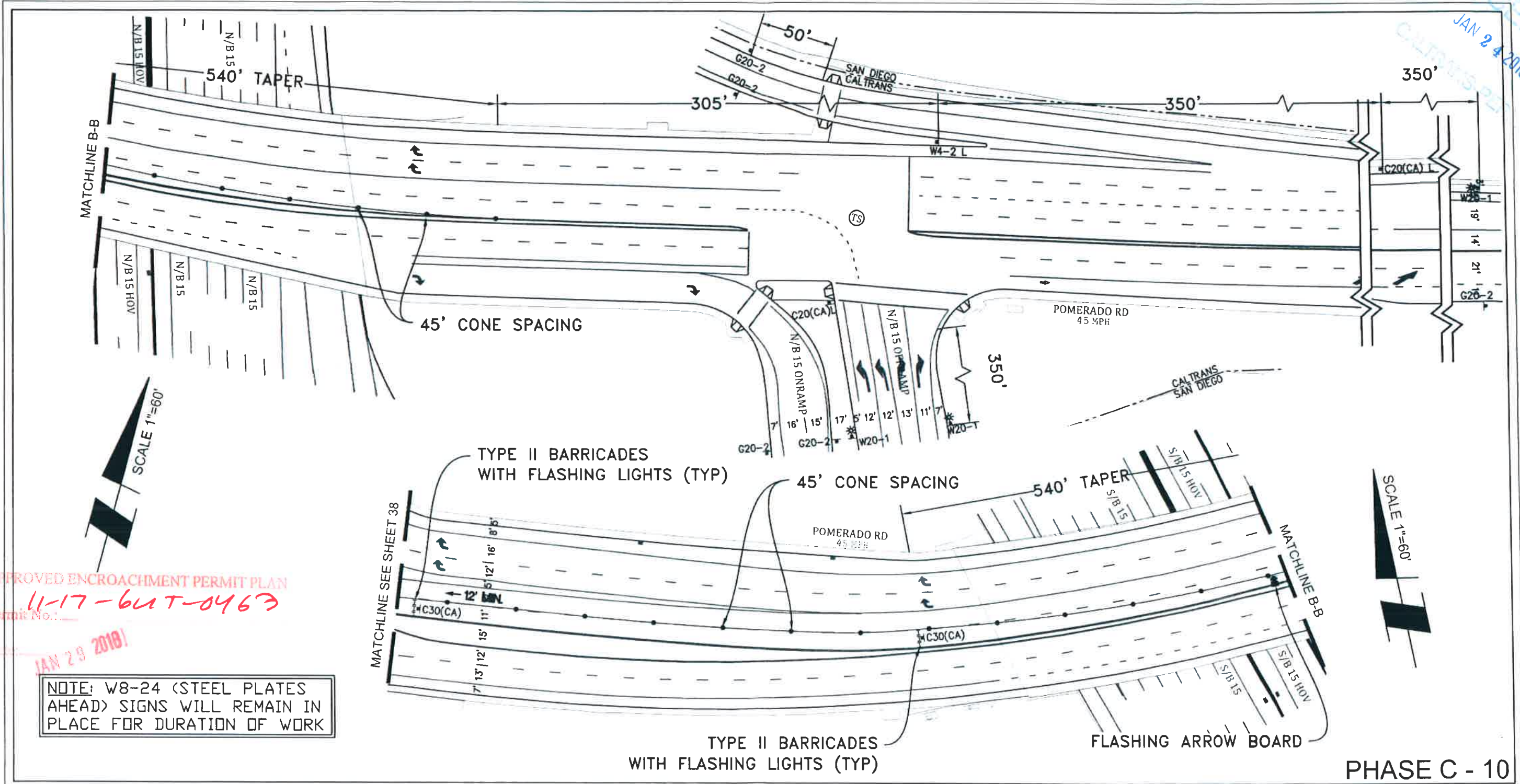

APPROVED ENCROACHMENT PERMIT PLAN
 Permit No. 11-17-641T-0463
 JAN 29 2018

NOTE: W8-24 (STEEL PLATES AHEAD) SIGNS WILL REMAIN IN PLACE FOR DURATION OF WORK

PHASE C - 10

PROJECT NAME: TL23071 - Sycamore Canyon Substation To Penasquitos Substation - 230 KV Underground

DATE: 1/22/2018
 DESIGNED: Clint Jones
 CHECKED BY: Mark Webb

UTILITY SURVEYORS, INC.
AIRX
 Gail McMorran
 President
 2534 EAST EL NORTE PARKWAY SUITE C
 ESCONCIDO, CA 92027
 PHONE: (760) 480-2347
 CELL: (760) 419-3738

NV5
 15092 AVENUE OF SCIENCE, SUITE 200
 SAN DIEGO, CA 92128
 P: 858 385.0500 WWW.NV5.COM

AIRX JOB#: X160218
 MISC/POTHOLE#:
 TYPE OF WORK: TRENCHING / CONDUIT

THOMAS GRID#: 1209-F6
 DRAWN FOR: CALTRANS



SHEET 39 OF 48

RECEIVED
 CALTRANS-PE
 JAN 24 2018
 SCALE 1"=60'

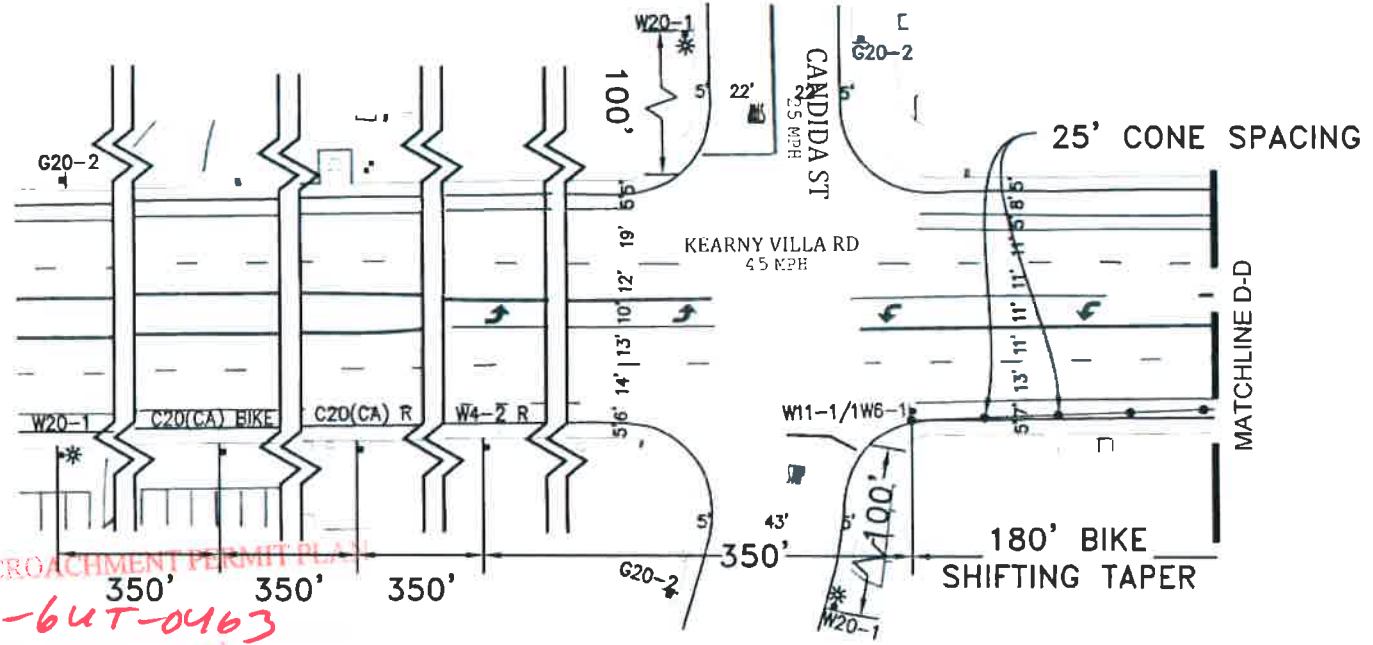
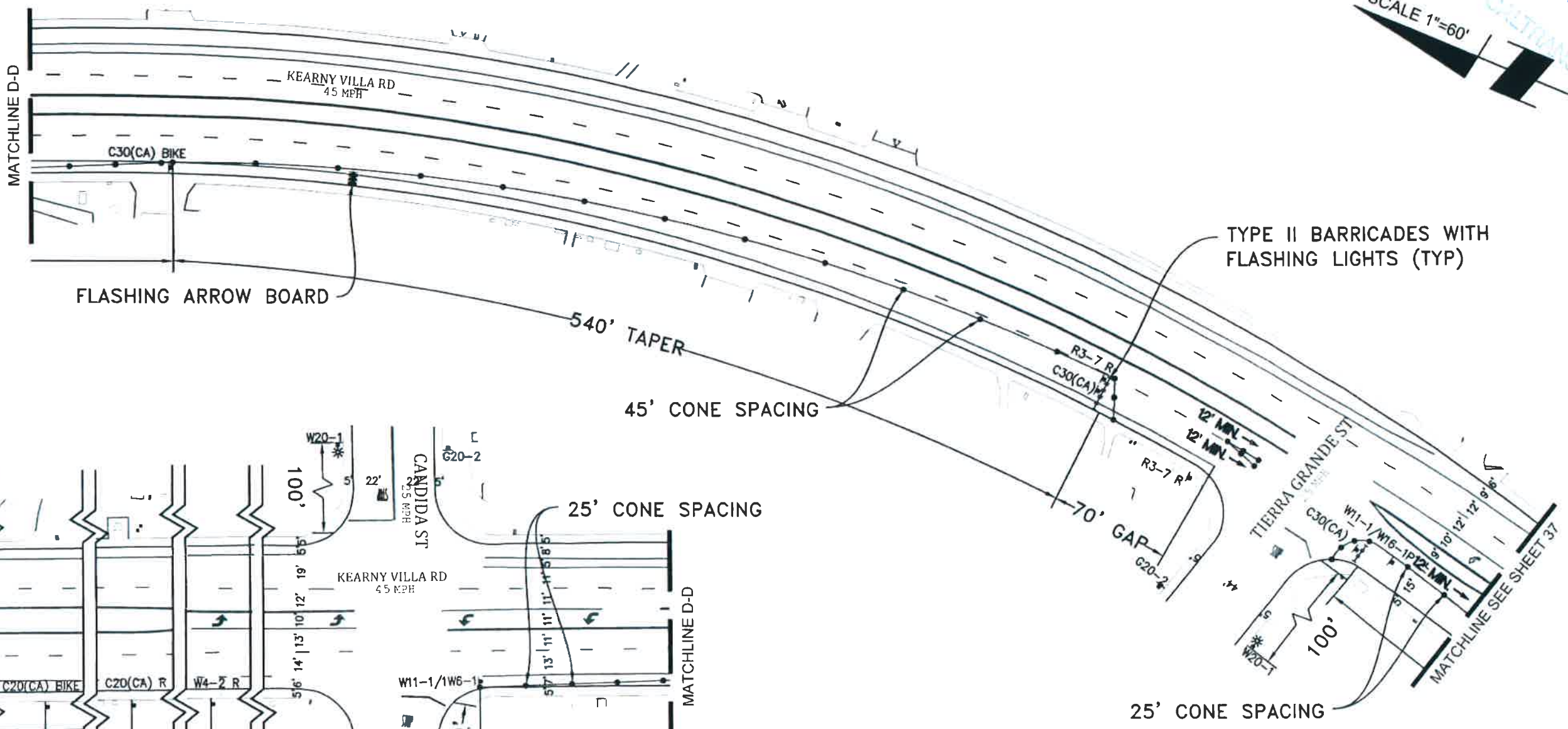

NOTE: W8-24 (STEEL PLATES AHEAD) SIGNS WILL REMAIN IN PLACE FOR DURATION OF WORK

APPROVED ENCROACHMENT PERMIT PLAN
 Permit No.: 11-17-64T-0463
 Date: 1/19/2018
 JAN 29 2018

PHASE C - 10

PROJECT NAME: TL23071 - Sycamore Canyon Substation To Penasquitos Substation - 230 KV Underground

DATE: 1/22/2018
 DESIGNED: Clint Jones
 CHECKED BY: Mark Webb

AIRX SURVEYORS, INC.
 Gail McMorran
 President
 2514 EAST EL NORTE PARKWAY, SUITE C
 ESCONDIDO, CA 92027
 PHONE: (760) 480-2347
 CELL: (760) 419-3738

NV5
 15092 AVENUE OF SCIENCE, SUITE 200
 SAN DIEGO, CA 92128
 P: 858.385.0500 WWW.NV5.COM

AIRX JOB#: X160218
 THOMAS GRID#: 1209-F6
 MISC/POTHOLE#: _____
 DRAWN FOR: CALTRANS
 TYPE OF WORK: TRENCHING / CONDUIT



SHEET 40 OF 48

RECEIVED
 CALTRANS-PE
 JAN 24 2018

NOTE: W8-24 (STEEL PLATES AHEAD) SIGNS WILL REMAIN IN PLACE FOR DURATION OF WORK

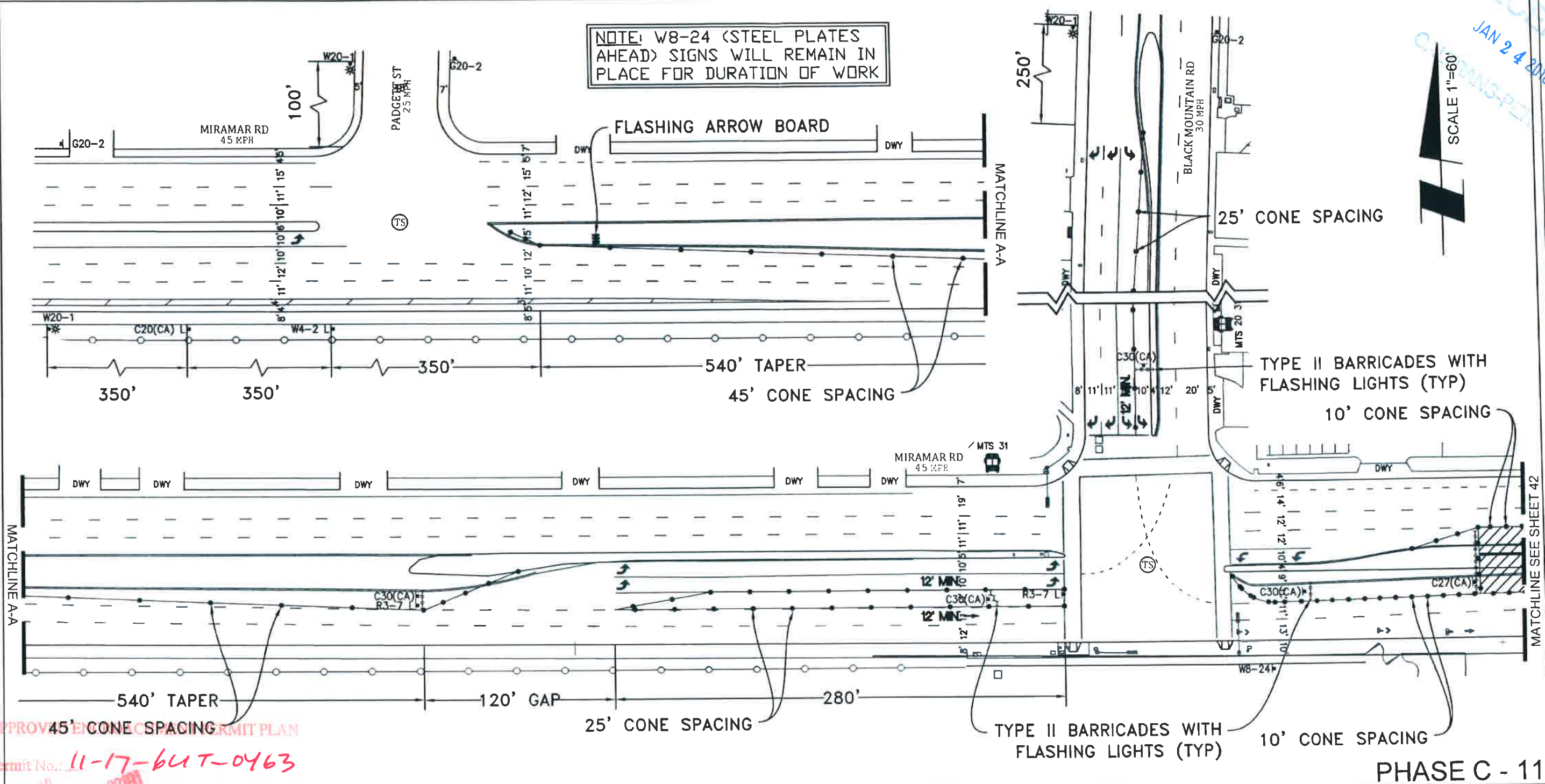

APPROVED PERMIT PLAN
 Permit No. 11-17-647-0463

PHASE C - 11

PROJECT NAME: TL23071 - Sycamore Canyon Substation To Penasquitos Substation - 230 KV Underground

AIRX SURVEYORS, INC.
 Gail McMorran
 President
 2534 EAST EL NORTE PARKWAY, SUITE C
 ESCONDIDO, CA 92027
 PHONE: (760) 480-2347
 CELL: (760) 419-3738

NV5
 15092 AVENUE OF SCIENCE, SUITE 200
 SAN DIEGO, CA 92128
 P: 858 385 0500 WWW.NV5.COM

AIRX JOB#: X160218
 MISC/POTHOLE#: _____
 TYPE OF WORK: TRENCHING / CONDUIT

THOMAS GRID#: 1209-F6
 DRAWN FOR: CALTRANS

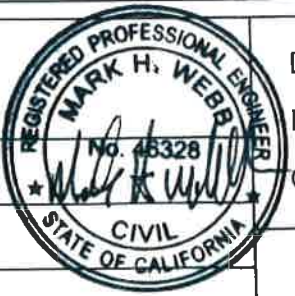

DATE: 1/22/2018
 DESIGNED: Clint Jones
 CHECKED BY: Mark Webb

SHEET 41 OF 48

RECEIVED
JAN 24 2018
CALTRANS PERMITS

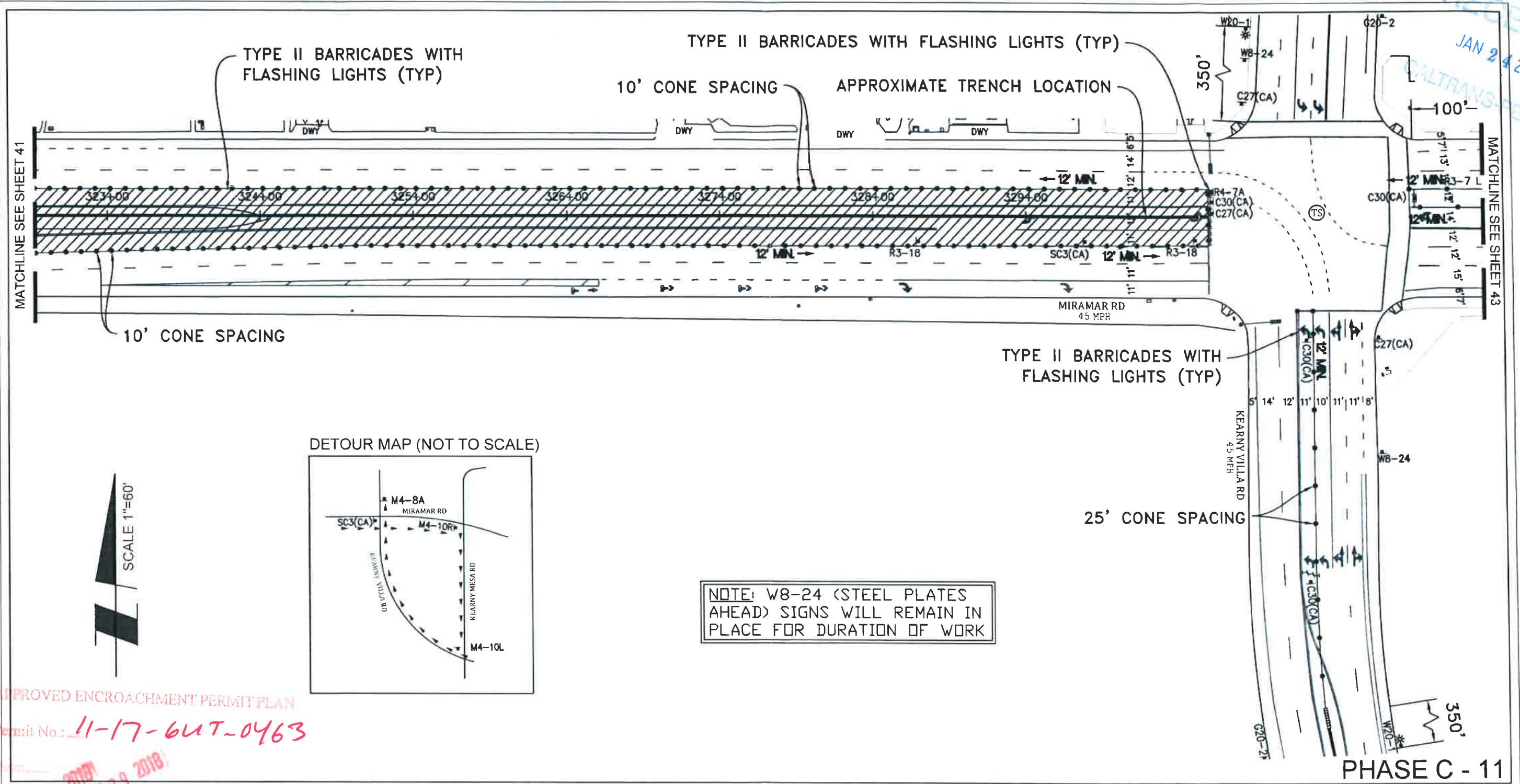

DETOUR MAP (NOT TO SCALE)

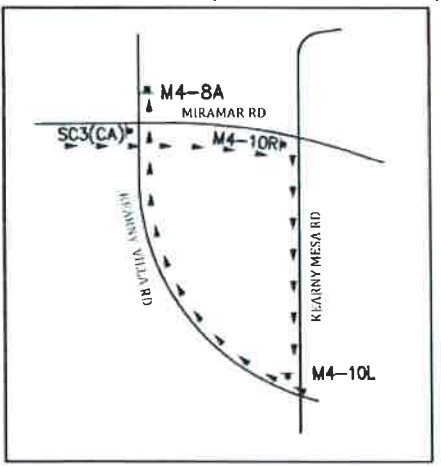

NOTE: W8-24 (STEEL PLATES AHEAD) SIGNS WILL REMAIN IN PLACE FOR DURATION OF WORK

APPROVED ENCROACHMENT PERMIT PLAN

Permit No.: 11-17-647-0463

DATE: JAN 19 2018
JAN 29 2018

PHASE C - 11

PROJECT NAME: TL23071 - Sycamore Canyon Substation To Penasquitos Substation - 230 KV Underground

DATE: 1/22/2018
DESIGNED: Clint Jones
CHECKED BY: Mark Webb

UTILITY SURVEYORS, INC.

 Gail McMorran
 President
 2534 EAST EL NORTE PARKWAY SUITE C
 ESCONDIDO, CA 92027
 PHONE (760) 480-2347
 CELL (760) 419-3738

N|V|5
 15092 AVENUE OF SCIENCE, SUITE 200
 SAN DIEGO, CA 92128
 P: 858 385 0500 WWW.NV5.COM

AIRX JOB#: X160218
 THOMAS GRID#: 1209-F6
 MISC/POTHOLE#: _____
 TYPE OF WORK: TRENCHING / CONDUIT

DRAWN FOR: CALTRANS

SHEET 42 OF 48

RECEIVED
 JAN 24 2018
 CALTRANS-P

SCALE 1"=60'

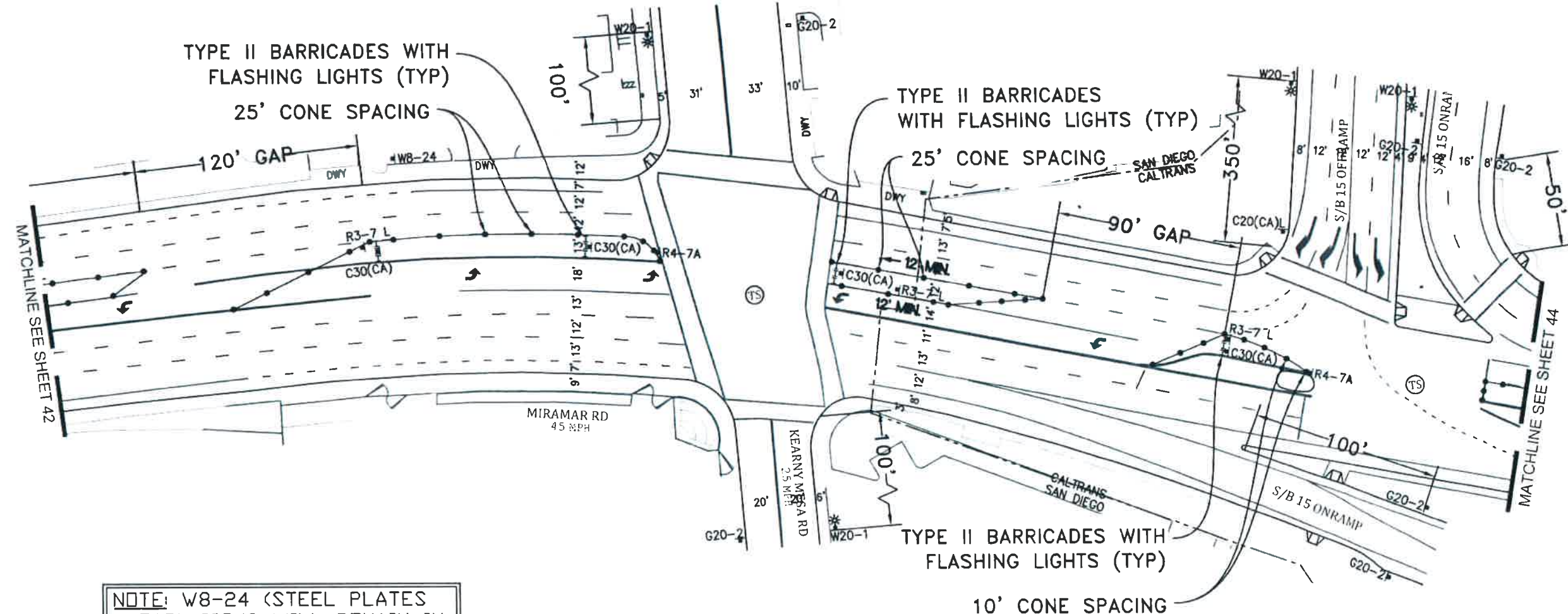

NOTE: W8-24 (STEEL PLATES AHEAD) SIGNS WILL REMAIN IN PLACE FOR DURATION OF WORK

APPROVED ENCROACHMENT PERMIT PLAN
 Permit No.: 11-17-6417-0463

PHASE C - 11

JAN 29 2018

PROJECT NAME: TL23071 - Sycamore Canyon Substation To Penasquitos Substation - 230 KV Underground

DATE: 1/22/2018
 DESIGNED: Clint Jones
 CHECKED BY: Mark Webb

UTILITY SURVEYORS, INC.
AIRX
 Gail McMorran
 President
 2534 EAST EL NORTE PARKWAY SUITE C
 ESCONDIDO, CA 92027
 PHONE (760) 490-2347
 CELL (760) 419-3736

NV5
 15092 AVENUE OF SCIENCE, SUITE 200
 SAN DIEGO, CA 92128
 P: 858.385.0500 WWW.NV5.COM

AIRX JOB#: X160218
 MISC/POTHOLE#:
 TYPE OF WORK: TRENCHING / CONDUIT

THOMAS GRID#: 1209-F6
 DRAWN FOR: CALTRANS

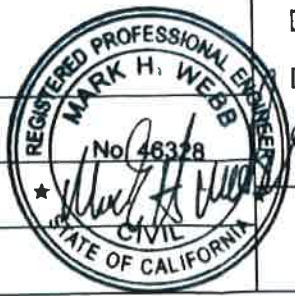

SHEET 43 OF 48

RECEIVED
JAN 24 2018
CALTRANS-P&E

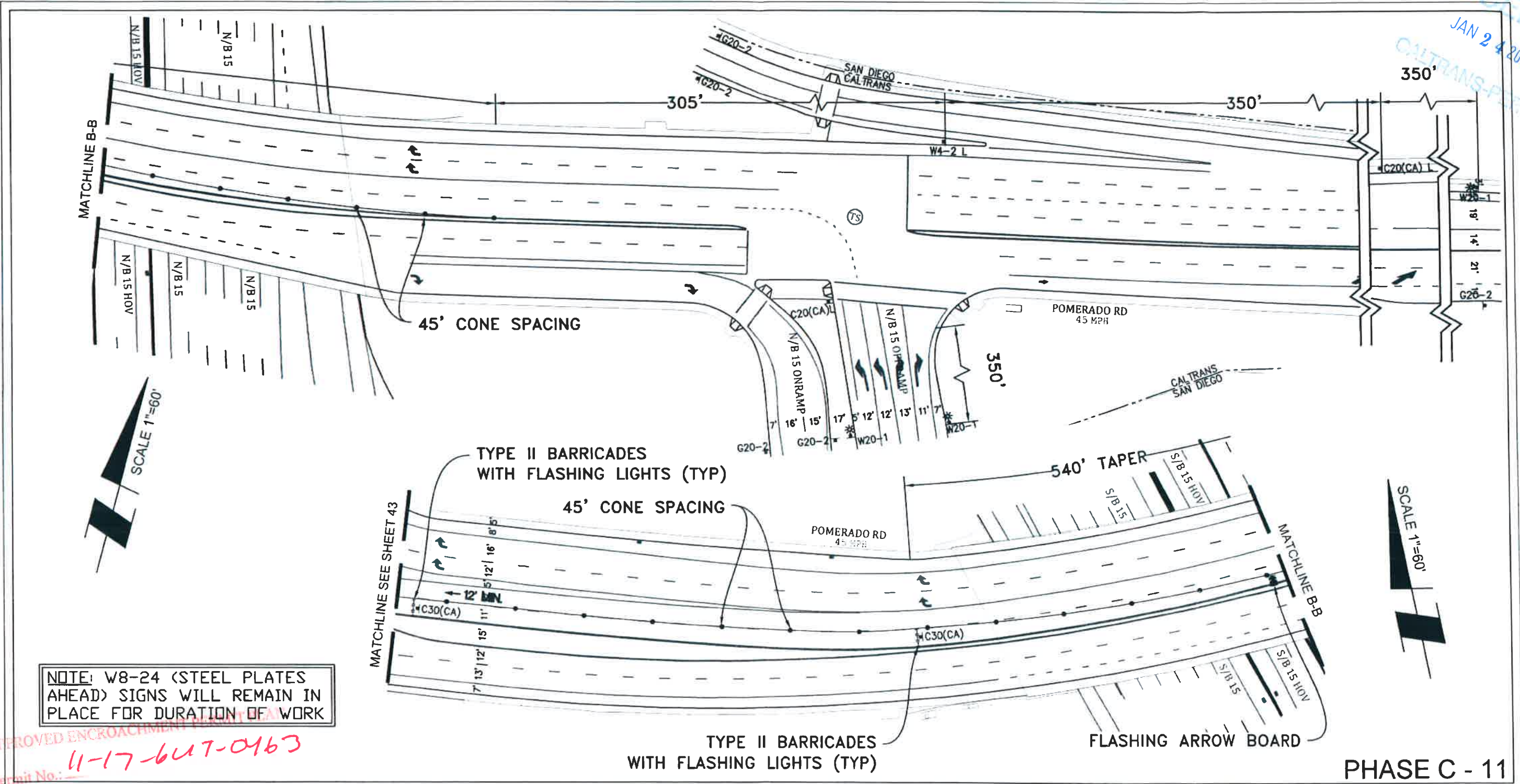

PHASE C - 11

PROJECT NAME: TL23071 - Sycamore Canyon Substation To Penasquitos Substation - 230 KV Underground

DATE: 1/22/2018
DESIGNED: Clint Jones
CHECKED BY: Mark Webb

UTILITY SURVEYORS, INC.
AIRX
Gail McMorran
President
2534 EAST EL NORTE PARKWAY SUITE C
ESCONDIDO, CA 92027
PHONE (760) 480-2347
CELL (760) 418-3738

NV5
15092 AVENUE OF SCIENCE, SUITE 200
SAN DIEGO, CA 92128
P: 858 385 0500 WWW.NV5.COM

AIRX JOB#: X160218
MISC/POTHOLE#:
TYPE OF WORK: TRENCHING / CONDUIT

THOMAS GRID#: 1209-F6
DRAWN FOR: CALTRANS



SHEET 44 OF 48

RECEIVED
 JAN 24 2018
 CALTRANS PER...

NOT TO SCALE

DETOUR MAP: (NOT TO SCALE)

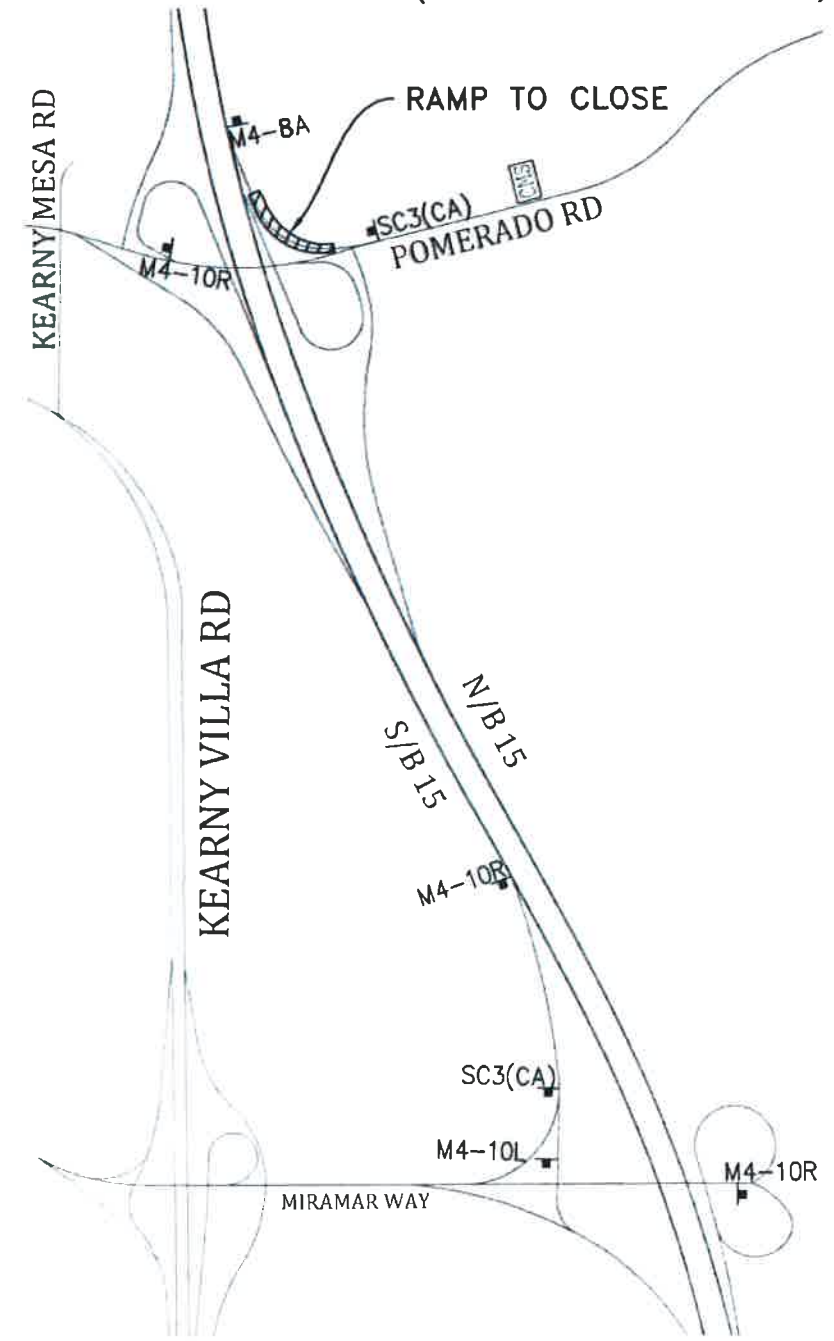

C.M.S. MESSAGE

RAMP CLOSED FROM	DATE TO DATE 9PM-5AM	DETOUR MIRAMAR WAY
------------------------	----------------------------	--------------------------

APPROVED ENCROACHMENT PERMIT PLAN
 Permit No.: **11-17-641T-0463**
 Date: **JAN 29 2018**

PHASE C - 4

PROJECT NAME: TL23071 - Sycamore Canyon Substation To
 Penasquitos Substation - 230 KV Underground

UTILITY SURVEYORS, INC.
AIRX
 Gail McMorran
 President
 2534 EAST EL NORTE PARKWAY, SUITE C
 ESCONDIDO, CA 92027
 PHONE (760) 480-2347
 CELL (760) 419-3738

N|V|5
 15092 AVENUE OF SCIENCE, SUITE 200
 SAN DIEGO, CA 92128
 P: 858 385 0500 WWW.NV5.COM

AIRX JOB#: X160218
 MISC/POTHOLE#:
 TYPE OF WORK: BORING

THOMAS GRID#: 1209-F6
 DRAWN FOR: CALTRANS



DATE: 1/22/2018
 DESIGNED: Clint Jones
 CHECKED BY: Mark Webb

SHEET 45 OF 48

RECEIVED
 JAN 24 2018
 CALTRANS-PER

NOTE: W8-24 (STEEL PLATES AHEAD) SIGNS WILL REMAIN IN PLACE FOR DURATION OF WORK

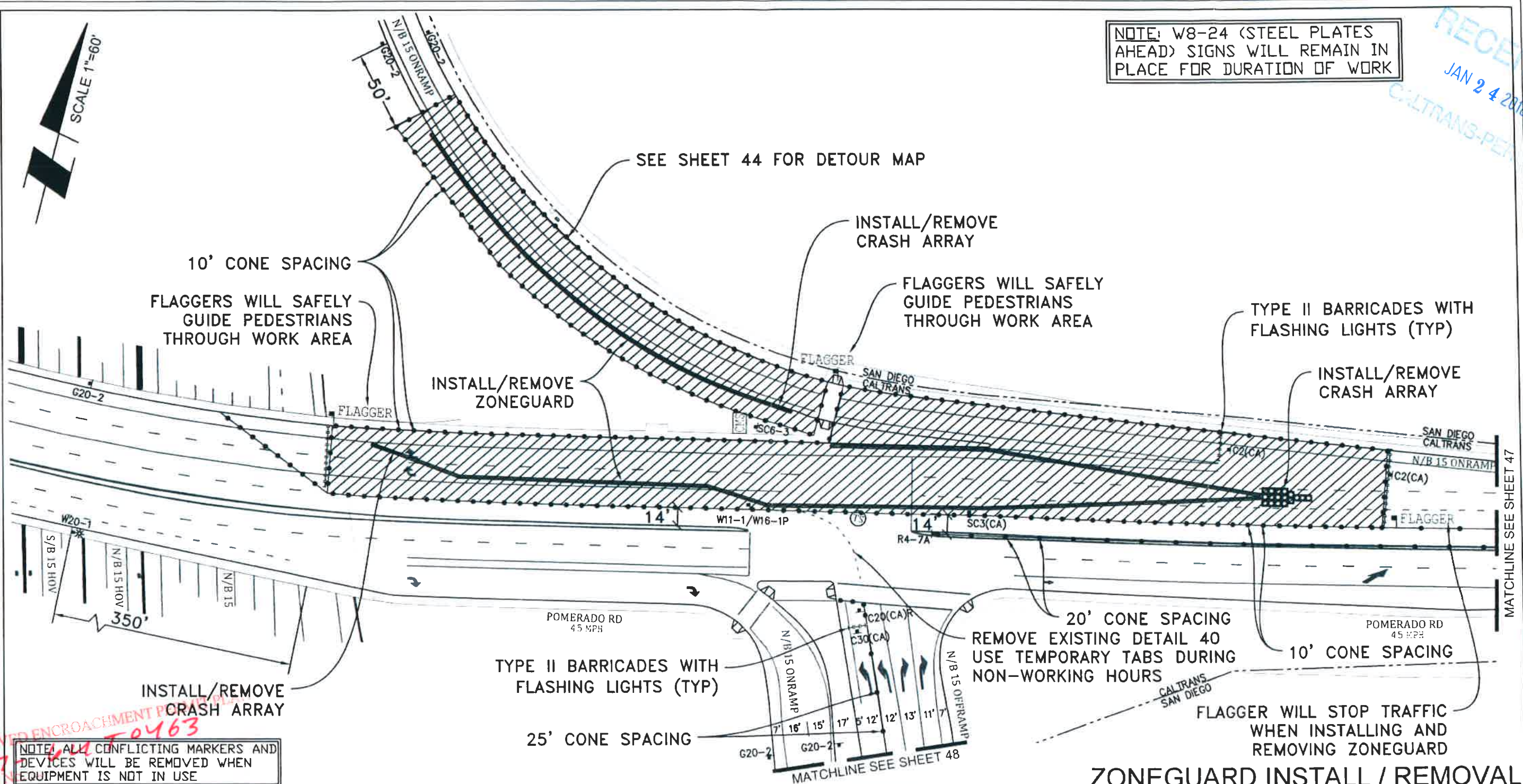

APPROVED ENCROACHMENT PERMIT
 11-17-18
 Permit # 10463

NOTE: ALL CONFLICTING MARKERS AND DEVICES WILL BE REMOVED WHEN EQUIPMENT IS NOT IN USE

ZONEGUARD INSTALL / REMOVAL

PROJECT NAME: TL23071 - Sycamore Canyon Substation To Penasquitos Substation - 230 KV Underground

DATE: 1/22/2018
 DESIGNED: Clint Jones
 CHECKED BY: Mark Webb

UTILITY SURVEYORS, INC.
AIRX
 2534 EAST EL NORTE PARKWAY, SUITE C
 ESCONDIDO, CA 92027
 PHONE: (760) 480-2347
 CELL: (760) 419-3738

N|V|5
 15092 AVENUE OF SCIENCE, SUITE 200
 SAN DIEGO, CA 92128
 P: 858 385 0500 WWW.NV5.COM

AIRX JOB#: X160218
 MISC/POTHOLES#:
 TYPE OF WORK: TRENCHING / CONDUIT

THOMAS GRID#: 1209-F6
 DRAWN FOR: CALTRANS



SHEET 46 OF 48

RECEIVED
 JAN 24 2018
 CALTRANS-PER

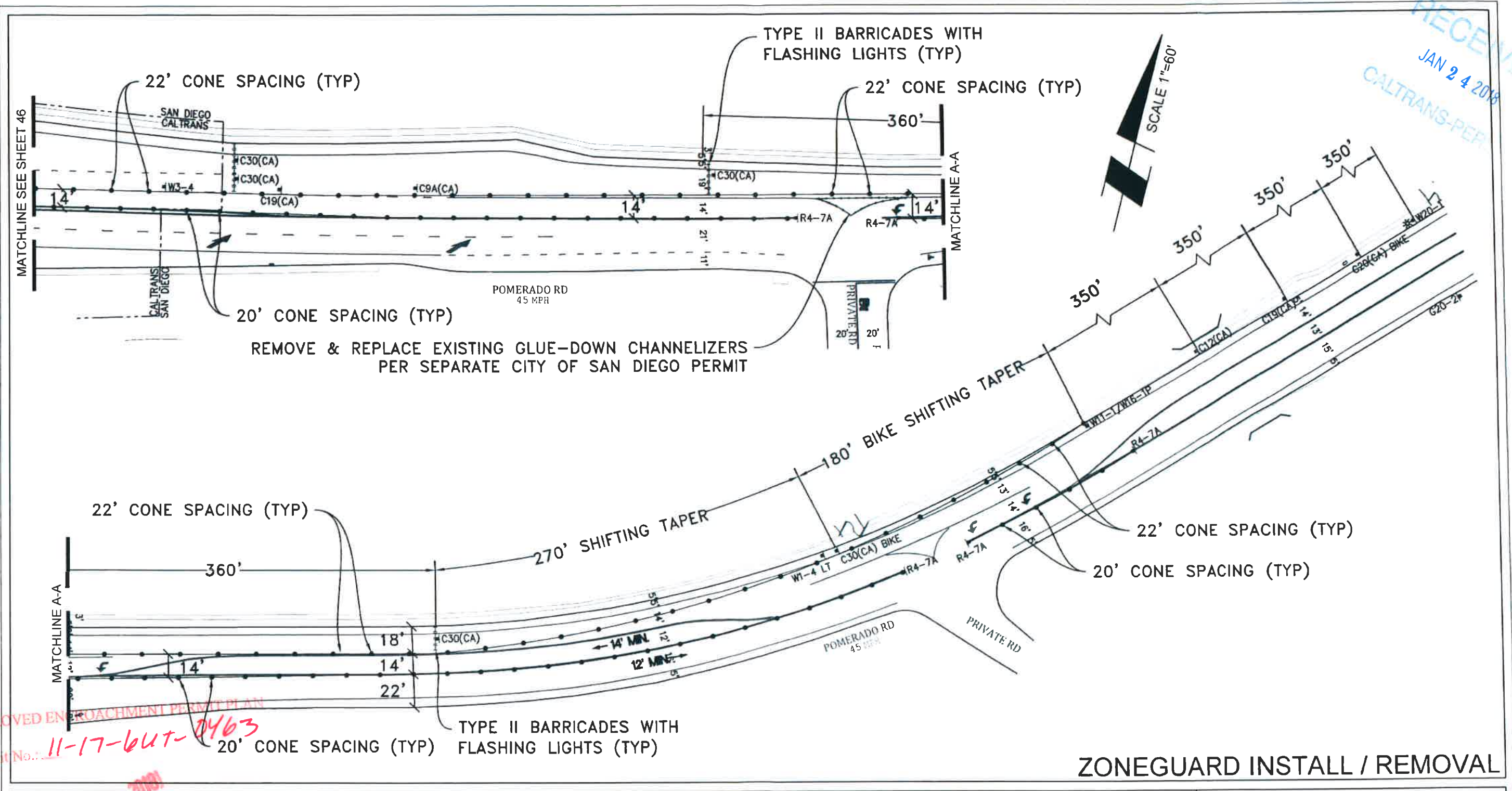

APPROVED ENCROACHMENT PERMIT PLAN
 Permit No.: 11-17-6UT-0463

ZONEGUARD INSTALL / REMOVAL

PROJECT NAME: TL23071 - Sycamore Canyon Substation To Penasquitos Substation - 230 KV Underground

DATE: 1/22/2018
 DESIGNED: Clint Jones
 CHECKED BY: Mark Webb

UTILITY SURVEYORS, INC.
AIRX
 Gail McMorrin
 President
 2534 EAST EL NORTE PARKWAY, SUITE C
 ESCONDIDO, CA 92027
 PHONE: (760) 480-2347
 CELL: (760) 419-3738

NV5
 15092 AVENUE OF SCIENCE, SUITE 200
 SAN DIEGO, CA 92128
 P: 858 385 0500 WWW.NV5.COM

AIRX JOB#: X160218
 MISC/POTHOLES#:
 TYPE OF WORK: TRENCHING / CONDUIT

THOMAS GRID#: 1209-F6
 DRAWN FOR: CALTRANS

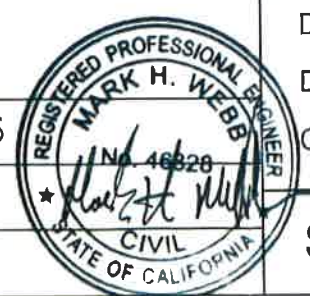

SHEET 47 OF 48

RECEIVED
JAN 24 2018
CALTRANS-PERMIT

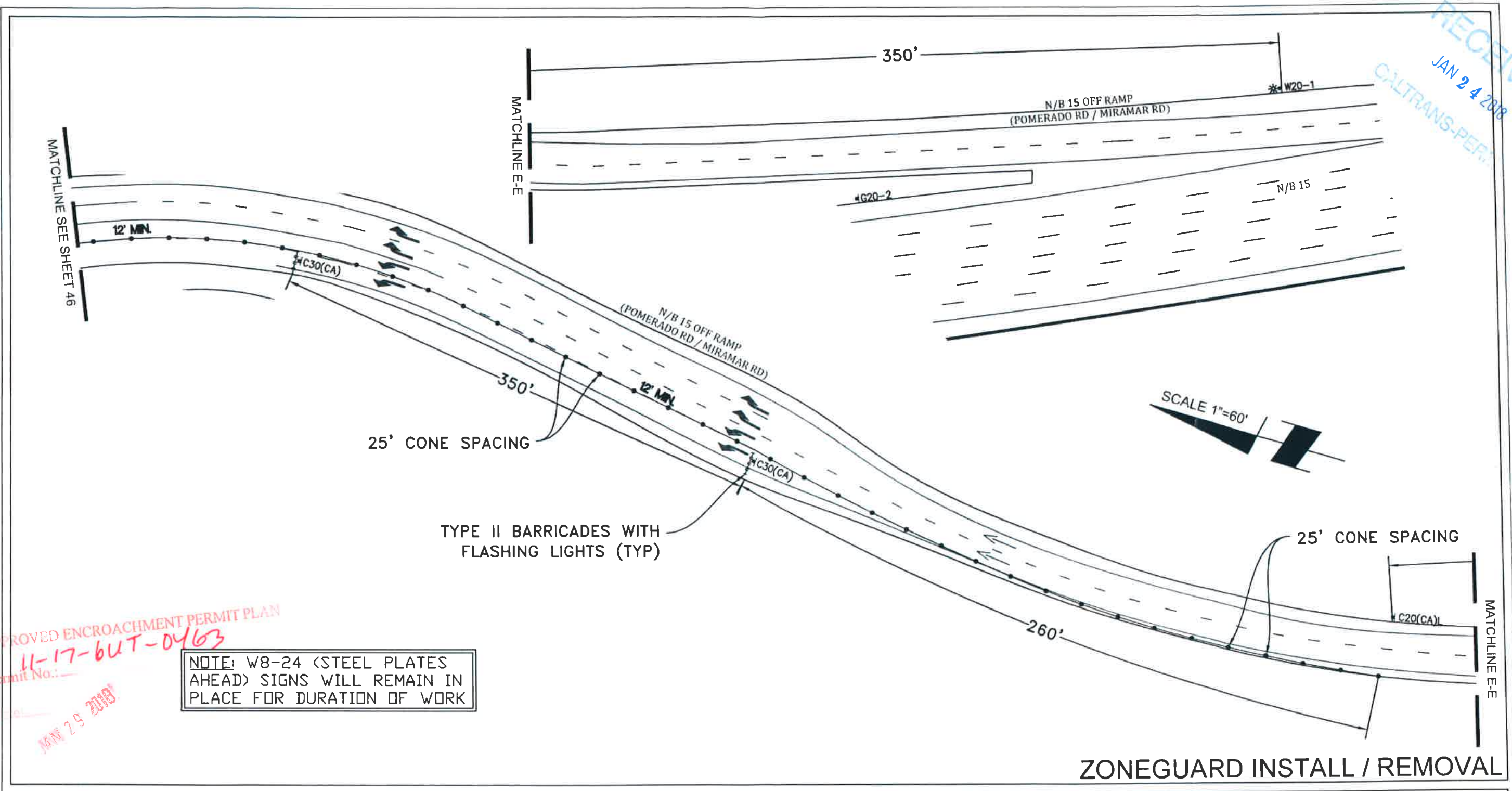

APPROVED ENCROACHMENT PERMIT PLAN
11-17-64T-0463
Permit No.:
Date: JAN 29 2018

NOTE: W8-24 (STEEL PLATES AHEAD) SIGNS WILL REMAIN IN PLACE FOR DURATION OF WORK

ZONEGUARD INSTALL / REMOVAL

PROJECT NAME: TL23071 – Sycamore Canyon Substation To Penasquitos Substation – 230 KV Underground

DATE: 1/22/2018
DESIGNED: Clint Jones
CHECKED BY: Mark Webb

UTILITY SURVEYORS, INC.
AIRX
Gail McMorran
President
2534 EAST EL NORTE PARKWAY SUITE C
ESCONDIDO, CA 92027
PHONE: (760) 480-2347
CELL: (760) 419-3738

N|V|5
15092 AVENUE OF SCIENCE, SUITE 200
SAN DIEGO, CA 92128
P: 858 385 0500 WWW.NV5.COM

AIRX JOB#: X160218
MISC/POTHOLES#: _____
THOMAS GRID#: 1209-F6
DRAWN FOR: CALTRANS



TYPE OF WORK: TRENCHING / CONDUIT

SHEET 48 OF 48