

**Specification for
PV & Storage Inverter Interactions using
IEC 61850 Object Models and
Capabilities**

(Draft v14)

Table of Contents

1. OVERVIEW.....	1
1.1 Background of EPRI's Photovoltaic & Storage Integration Program.....	1
1.2 Introduction to the Specification.....	1
1.3 Different PV/Storage Inverter Management Methods.....	2
1.3.1 Directly Managed PV Systems.....	2
1.3.2 Interactive Control of Autonomous PV Inverters.....	3
1.3.3 Broadcast or Multicast Requests to Groups of PV Inverters.....	4
1.4 Differing DER Architectures.....	4
1.4.1 Conceptual Architecture: Electrical Coupling Point (ECP).....	4
1.4.2 Utility Interactions Indirectly with PV Inverters via a Customer EMS.....	5
1.4.3 Utility Interactions Directly with PV Inverter Controllers.....	6
1.5 General Sequence of Interactions.....	7
1.6 Levels of Compliance with this Specification.....	9
2. CONTROL FUNCTIONS FOR PV INVERTERS.....	10
2.1 Basic Control PV Inverter Functions.....	10
2.1.1 Function PC1: Connect / Disconnect from Grid.....	10
2.1.2 Function PC2: Adjust Maximum Generation Level Up/Down.....	11
2.1.3 Function PC3: Adjust Power Factor.....	11
2.2 PV/Storage Functions.....	12
2.2.1 Function PC4a: Request Real Power (Charge or Discharge Storage).....	12
2.2.2 Function PC4b: Provide Pricing Signal.....	13
2.2.3 Function PC4c: Modify PV/Storage Settings.....	14
2.3 Reporting Functions.....	15
2.3.1 Function PC5: Event/History Logging.....	15
2.3.2 Function PC6: Status Reporting.....	21
2.4 Periodic Commands.....	24
2.4.1 Function PC7: Time Synchronization.....	24
2.5 VAR Modes for Decentralized Var Support from PV/Storage Inverters.....	25
2.5.1 VAR Management Modes and Volt/Var Arrays (SubModes).....	25
2.5.2 VAR Mode PV1: Normal Energy Conservation Mode.....	26
2.5.3 VAR Mode PV2: Maximum Var Support Mode.....	27
2.5.4 VAR Mode PV3: Static Var Mode.....	29
2.5.5 VAR Mode PV4: Passive Mode.....	30
3. SCHEDULED ACTIONS.....	32
3.1 Scheduling Using Different Bases: Time, Temperature, Pricing Signals.....	32

3.2	Scheduling for Charging / Discharging in PV/Storage Systems.....	33
3.3	Scheduling Var Modes.....	34
3.4	Scheduling Using Pricing Signals (or Value) of Energy.....	34
4	IEC 61850 OBJECT MODELS FOR PV INVERTERS.....	36
4.1	IEC 61850 Direct Commands.....	36
4.1.1	IEC 61850 Models for PC1: Connect/Disconnect.....	36
4.1.2	IEC 61850 Models for PC2: Raise/Lower.....	36
4.1.3	IEC 61850 Models for PC3: Adjust Power Factor and/or Volt/Var Settings.....	37
4.2	IEC 61850 PV/Storage Commands.....	37
4.2.1	IEC 61850 Models for PC4: Control Energy Flow.....	37
4.3	IEC 61850 Reporting Commands.....	39
4.3.1	IEC 61850 Models for PC5: Event/History Logging 61850 Models.....	39
4.3.2	IEC 61850 Models for PC6: Status Reporting.....	40
4.4	IEC 61850 Periodic Commands.....	41
4.4.1	IEC 61850 Models for PC7: Time Synchronization.....	41
4.5	IEC 61850 Decentralized Var Support Using IEC 61850.....	41
4.5.1	IEC 61850 Volt/Var Array (SubMode) Settings.....	41
4.5.2	IEC 61850 PV Mode Request for Non-Schedule-based Modes.....	42
4.5.3	IEC 61850 PV Mode Response.....	42
4.5.4	IEC 61850 Scheduling PV Modes.....	43
4.5.5	IEC 61850 Scheduling PV/Storage.....	44
5.	FUTURE ACTIVITIES.....	45
5.1	Abstract Object Models and Communication Protocols.....	45
5.2	Possible Additional Utility-DER Interactions.....	46
5.2.1	Watt / Frequency or Watt/Voltage Modes.....	46
5.2.2	Advanced Schedules.....	46
5.2.3	Voltage Sag Ride-Through.....	46
5.2.4	Separate Watt and Var Management.....	46
5.2.5	Grid-Connected Converter Interactions.....	47
5.2.6	Harmonic Cancellation.....	48
6.	MEMBERS OF PV INVERTER DATA IDENTIFICATION FOCUS GROUP (DIFG).....	48

1. Overview

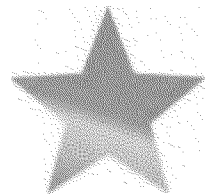

1.1 Background of EPRI's Photovoltaic & Storage Integration Program

In 2009, EPRI's Photovoltaic & Storage Integration Program (P174) began a series of studies related to the high penetration of distributed energy resources (DER). One research area in this program is specifically focused on the communication aspects of DER integration. This research led, in mid 2009, to the launch of a broad industry collaborative to identify a common means by which smart, communicating inverters may be integrated into utility systems.

The Department of Energy, Sandia National Laboratories, and the Solar Electric Power Association have been historically active in this area of study and have joined with EPRI in steering the overall project. At the present (February 2010), the project has engaged 350 individuals representing inverter providers, utilities, and research organizations.

The central goal of the project is to identify a core set of common inverter capabilities that, if made available, may enable higher penetration levels and enhance the value of grid-tied PV and storage devices. By working closely with the community of inverter manufacturers, the project hopes to allow for innovation and evolution of devices, while at the same time making it possible to standardize communication messages for those functions that are common.

The project was formally kicked-off at a workshop held in Albuquerque, NM during the DOE's SEGIS-ES conference. At that workshop, a large range of use cases that had been previously collected were down-selected into seven functions that were deemed most needed. More detail about the project history is included in a previous update that was published as Report # 1020435 (available at epri.com).

1.2 Introduction to the Specification

These specifications cover interactions between utilities (or their surrogate energy service providers (ESP)) and PV/Storage systems. The PV systems can range from 1) very small grid-connected PV systems at residential customer sites, tied into the grid through net metering to 2) medium PV systems managing campus or community PVs to 3) very large PV plants. These PV systems may or may not include DC-connected energy storage capabilities as integral parts of their management. The focus is on PV inverter management and does not cover any other types of energy management.

These specifications cover a limited set of functions in an attempt to take baby steps before trying to define a larger and/or more complex set of functions. Therefore, in no way do these functions try to limit what can be tried or implemented beyond them – the key idea is that **IF** the functions covered in this specification are implemented, **THEN** they will be implemented as specified below.

1.3 Different PV/Storage Inverter Management Methods

There are three methods to manage PV/storage inverters:

- Direct management by a PV controller of a specific PV inverter: tightly coupled commands assuming complete knowledge of the PV inverter status and capabilities
- Interactive management of PV controllers: loosely-coupled requests assuming key knowledge of current PV inverter status, but allowing the autonomous PV controller to accept, not accept, or modify the request based its internal knowledge of the inverter or storage unit capabilities. The PV controller provides feedback to the requester.
- Broadcasting or multicasting to specific types/sizes/regions of PV inverters: open requests without the expectation of any directly communicated responses. Only changes in the power system (voltage, vars, load level, etc.) and the eventual metering of the PV inverter provide feedback.

The latter two methods could issue single control requests or could provide a schedule of control requests based on time, temperature, pricing signal, or other parameters.

These different PV management interactions are shown in the general DER system illustrated below.

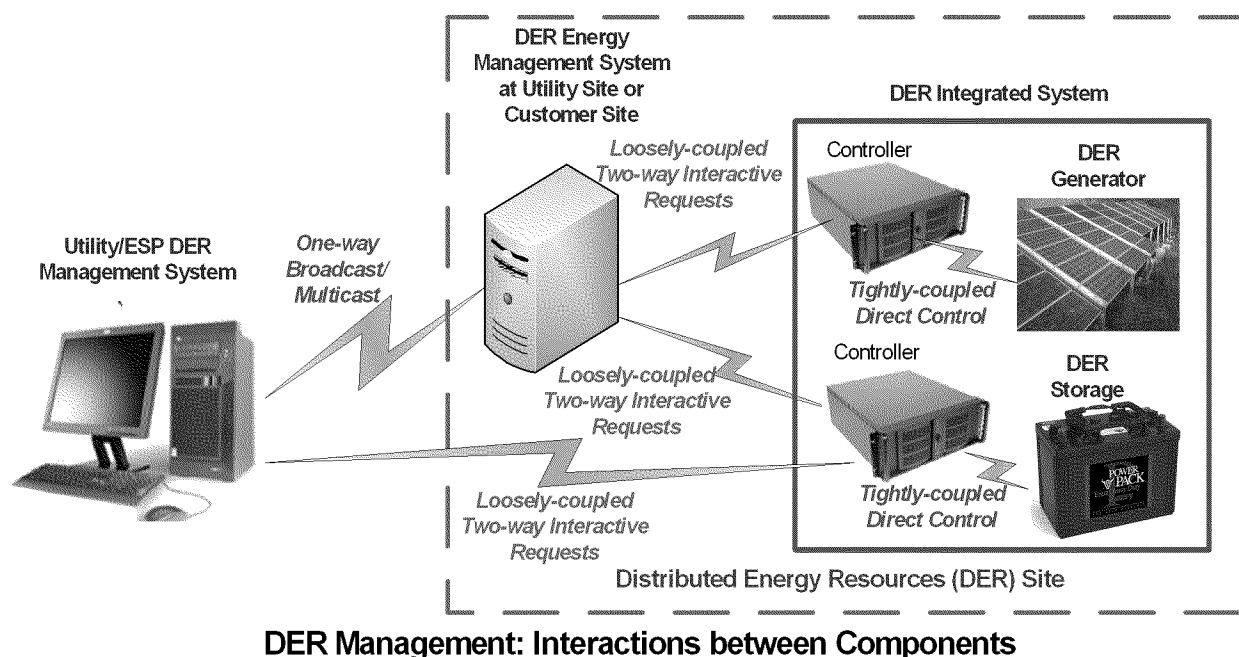

1.3.1 Directly Managed PV Systems

Directly managed PV systems have their components (inverters, PV panels, storage, etc.) directly monitored and controlled by a separate controller. With managed PV systems, the intelligence that makes the PV settings and the storage charge/discharge decisions is in the separate controller. This separate controller can issue settings, get status information, monitor measured values, and command control actions of specific PV inverters with the expectation of communicated replies acknowledging the commands and providing the status and/or response information. This method

provides tightly-coupled control, and requires active and rapid interactions between the controller and the PV inverter.

This separate controller may receive requests and other information from external systems (such as a customer EMS, a utility, or an energy service provider). The controller may also, depending upon its capabilities, utilize schedules of energy prices, weather forecasts, expected customer requirements for stored energy at different times, etc. to determine what direct control commands it will issue to the PV inverter or other component.

Examples of direct commands include:

- Connect/disconnect from grid (see PC1)
- Charge to % of capacity at specified ramp rate or for specified length of time (see PC4a)
- Discharge to % of capacity at specified ramp rate or for specified length of time (see PC4a)

Pricing signal to provide information for autonomous PV/Storage system on which to make charging/discharging decisions.

The communications between such a separate controller and the components it is controlling may be proprietary if it is provided as a turn-key integrated “autonomous” system. If, however, the controller and the PV inverter are provided separately, then communication standards should be used.

1.3.2 Interactive Control of Autonomous PV Inverters

Autonomous PV systems locally manage their own settings, including charging and discharging of any energy storage units. They use both local data and general information that may be provided to the system. General information might include schedules of energy prices, weather forecasts, expected customer requirements for stored energy at different times, and expected availability of locally produced energy (e.g. PV system). An example of an autonomous PV system would be a residential customer-owned PV-inverter-and-battery-storage system that is charging and discharging according to preferences set by the customer. Any communications between components of the autonomous system are handled internally. Only communications between the autonomous PV system and external systems would be within the scope of this specification.

An example of a managed PV system would be a utility-owned PV plant (with multiple PV inverters and energy storage units) that is managed via a SCADA system by a centralized control application.

The primary difference between these managed systems and autonomous systems is that the separate controllers would be required to use standards (i.e. IEC 61850) for communicating with the individual components of the PV/storage system, in addition to communications with external systems.

Direct control would typically be utilized for larger PV installations or for utility-owned PV inverters. The utility could send volt/var settings with the request for the PV inverter controller to go to those settings immediately, and the PV inverter would reply directly back to the utility. The utility could periodically update the volt/var settings as needed, such as every few hours.

1.3.3 Broadcast or Multicast Requests to Groups of PV Inverters

Broadcast or multicast requests would be sent to groups of PV inverters without the expectation of communicated . This broadcast approach would be termed decentralized and “loosely-coupled”.

Broadcasts or multicasts would be used typically for smaller PV inverters. For these smaller PV inverters, the utility would not want to get (or may not be able to get) any explicit response back from the PV inverters on whether or not they responded or by how much. The utility would rely primarily on aggregated response of these PV systems rather than on specific responses by individual PV inverters.

This is an individual design or implementation consideration, based on the need of the utility for precise results. They can see general results as they monitor the power system in real-time, and can assess more specific results much later as they get information from the metering systems.

1.4 Differing DER Architectures

1.4.1 Conceptual Architecture: Electrical Coupling Point (ECP)

Some PV/Storage systems may be directly connected to the utility grid, while others may be part of a site microgrid. In either case, the PV/Storage systems will have a point of electrical connection, which is defined as:

“The point of electrical connection between the DER source of energy (generation or storage) and any electric power system (EPS). Each DER (generation or storage) unit has an ECP connecting it to its local power system; groups of DER units have an ECP where they interconnect to the power system at a specific site or plant; a group of DER units plus local loads have an ECP where they are interconnected to the utility power system.

NOTE For those ECPs between a utility EPS and a plant or site EPS, this point is identical to the point of common coupling (PCC) defined in the IEEE 1547 “Standard for Interconnecting Distributed Resources with Electric Power Systems”.

This concept is illustrated in Figure 1.

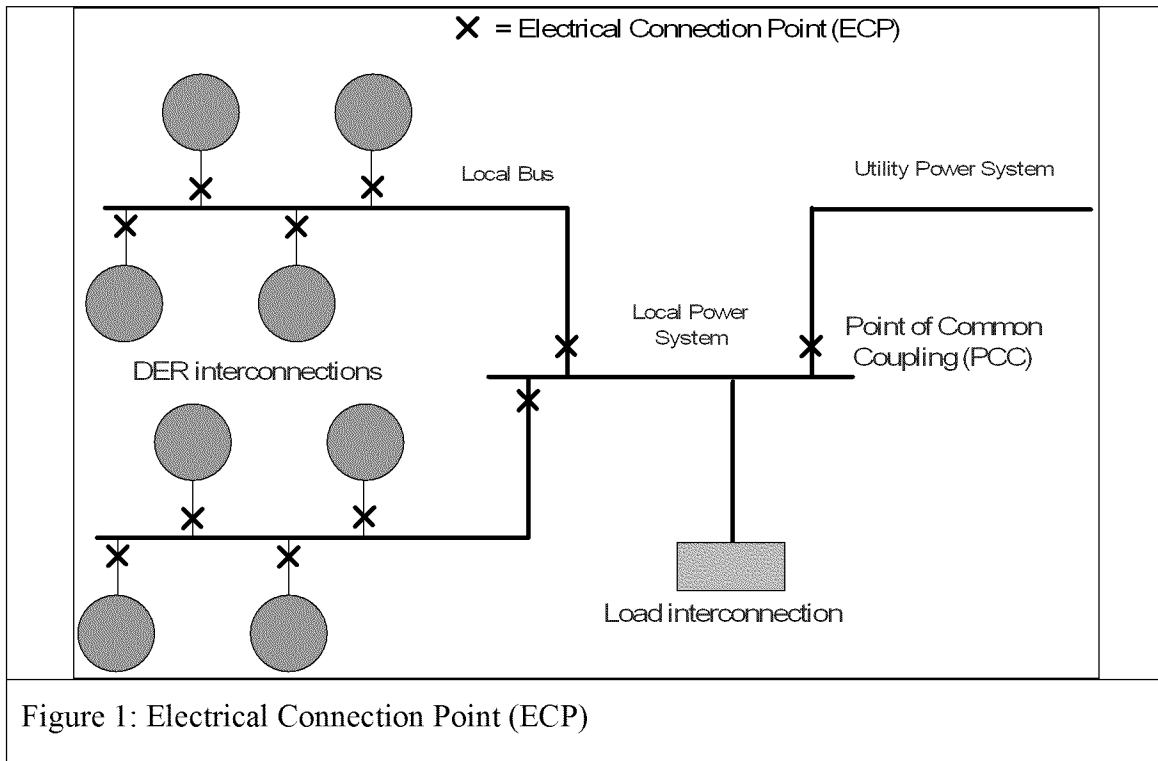

1.4.2 Utility Interactions Indirectly with PV Inverters via a Customer EMS

Utilities can interact with PV/Storage systems using different architectures. The following diagram illustrates the use of a Customer EMS to help manage PV inverter responses to the broadcast utility request, with the idea that this Customer EMS will possibly be managing multiple PV inverters, customer appliances, other types of distributed generators and storage devices, and plug-in electric vehicles. For instance, if the utility broadcasts a specific request for PV inverter actions, then these can be passed directly or indirectly (through explicit commands) to the PV inverters. If the utility broadcasts Demand Response signals or more generic volt/var requests, then the Customer EMS could use other devices in addition to PV inverters to meet these requests. With this approach, the Customer EMS could manage responses locally to meet the requests with the most effective mix of devices.

From a communications perspective, the utility broadcast to the customer site, between the utility and the “Customer EMS”, could use different technologies at different layers, for example:

- Transport layers: Internet, GPRS, AMI network, private network
- Application protocols: Web services, XML-based, ANSI C12.22, DNP3, MMS
- Object models: IEC 61850

For the communications within the customer site between the “Customer EMS” and the PV inverter, the following communications technologies could be used at different layers, for example:

- Transport layers: ZigBee, HomePlug, Intranet
- Application protocols: Web services, XML-based, SEP, MMS

- Object models: IEC 61850

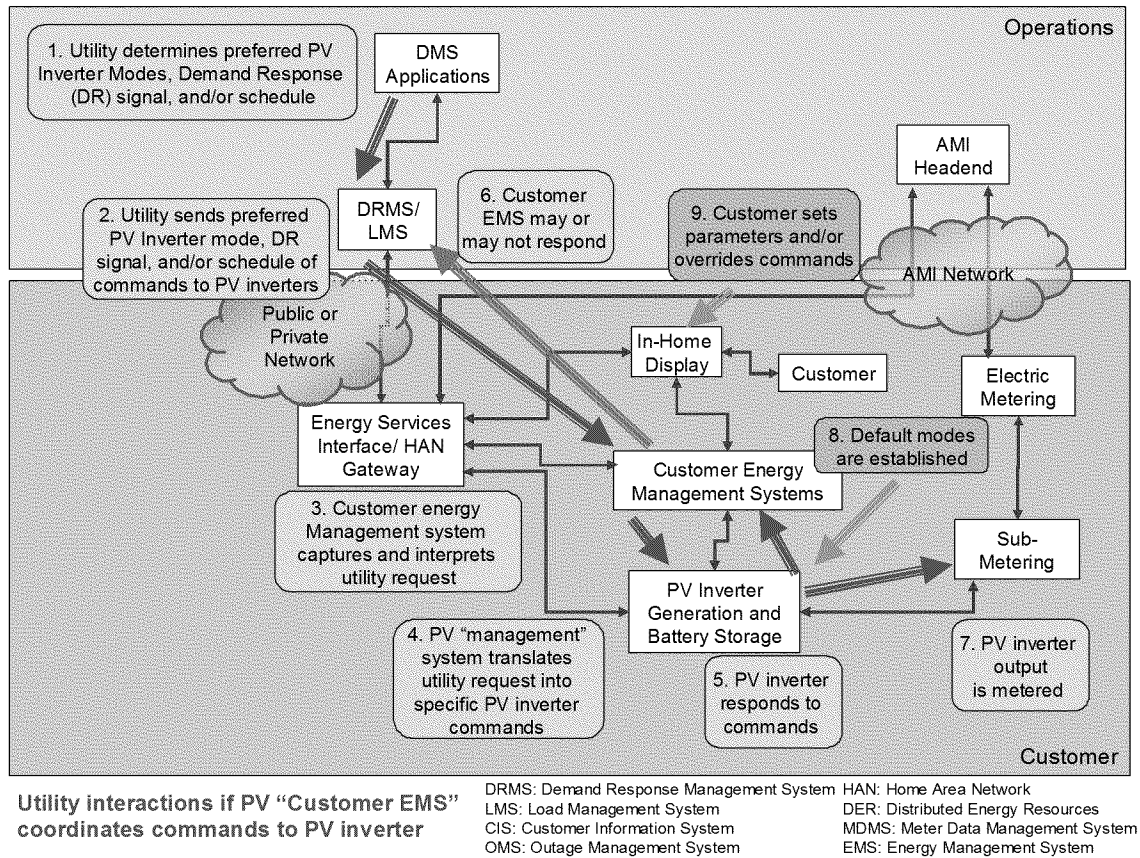

Figure 2: Utility interactions with PV inverters via a Customer EMS

1.4.3 Utility Interactions Directly with PV Inverter Controllers

Alternatively, utilities can communicate requests directly with PV inverter controllers. These requests are then interpreted by the PV inverter controllers.

From a communications perspective, the utility broadcast to the customer site, between the utility and the PV inverter, could use different technologies at different layers, for example:

- Transport layers: Internet, GPRS, AMI network, private network
- Application protocols: Web services, XML-based, ANSI C12.22, DNP3, MMS
- Object models: IEC 61850

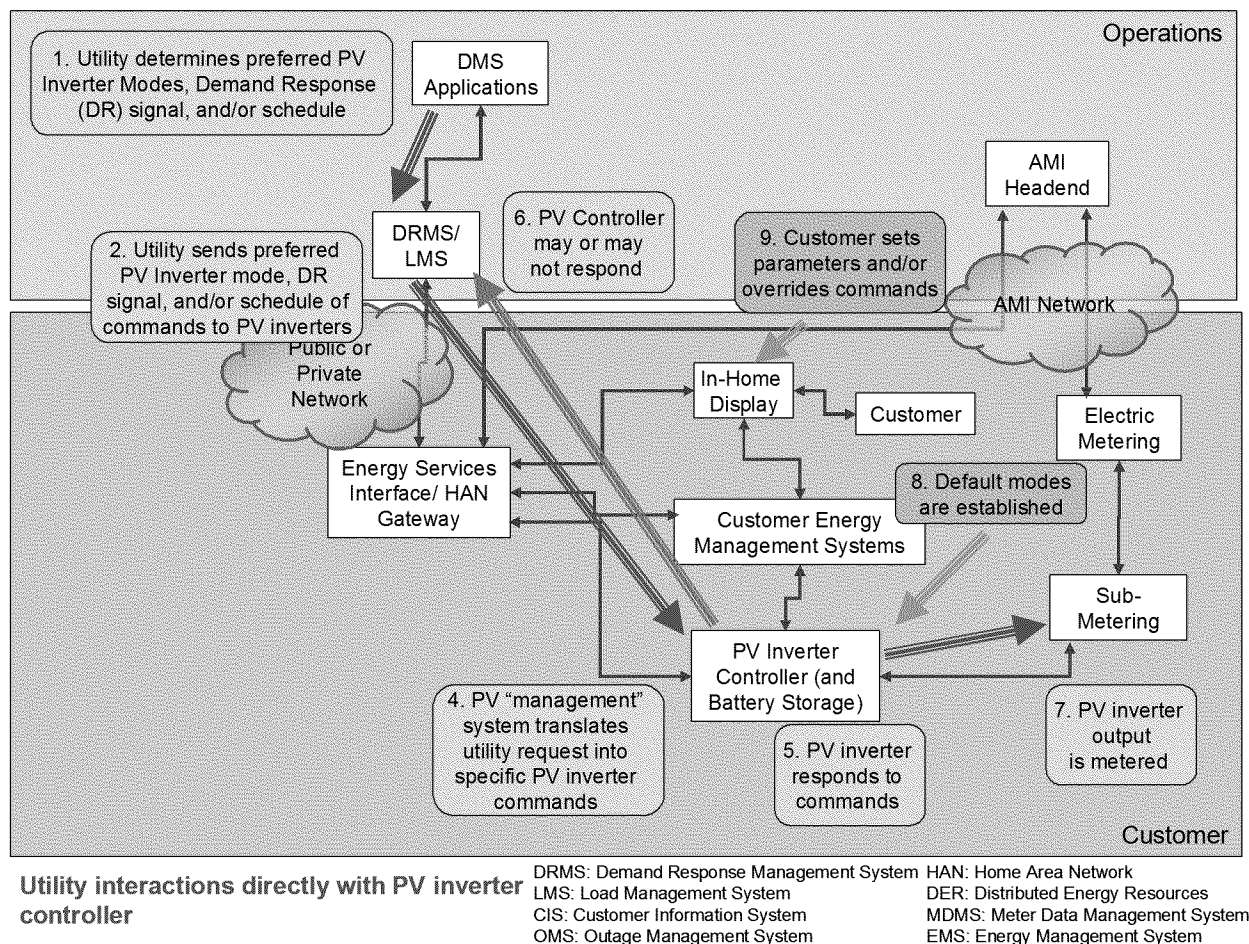

Figure 3: Utility interactions directly with PV inverters

1.5 General Sequence of Interactions

The (generic) sequence for interactions between a utility and PV inverters is (see Figure 2 and Figure 3):

1. **The utility determines what types of services** are desired from PV inverters within a region, on a feeder, or in some other area. This determination will be based on assessments of the power system status, abilities of other equipment to perform the required actions (e.g. capacitor banks for var control), market considerations, etc.
2. **The utility broadcasts a general request** that PV inverters (within a region or feeder or other area) go into a specific mode or that certain parameters are set. This request may be sent either to individual PV inverter controllers, or to more general “Customer EMSs” that know how to interpret such requests for the PV inverter controllers that they are managing. In either case, the utility does not necessarily need to know anything about the PV inverter capabilities, current PV status, market or tariff agreements on using the PV system, or desires of the PV owner.

3. At each customer site or other facility, the **PV inverter controller OR a Customer “energy management system” (EMS) receives and interprets this broadcast utility request.**
4. **If a Customer EMS is used:**
 - a. **The Customer EMS interprets the utility request.** It determines whether it will take any action, and what the command(s) will be to the PV inverter controller(s) under its control, including responding to any customer overrides or changes. These actions could be explicit commands to each PV inverter it is managing, or could be a schedule of commands if the PV inverter has the ability to handle schedules.
 - b. **The Customer EMS then issues specific commands to the PV inverter(s):** First it requests (or already has) the current status of the PV inverter(s), modifies the command if necessary to reflect the status, and then issues the appropriate command.
 - c. **The PV inverter(s) respond to the Customer EMS command,** indicating success or rejection, as well as any error codes. In addition, the current status of the PV inverter could be sent if either explicitly requested by the Customer EMS or if it is “automatically” sent as part of the sequence.
 - d. **The Customer EMS may or may not be required to respond** to the utility request.
 - If the utility does not expect a direct response, it may both monitor conditions to determine if enough power system changes have occurred and/or read the meter (or meter event log) to determine if the PV inverter responded appropriately.
 - If it does respond, it will acknowledge receipt of the command and returning the appropriate information.
5. **If a PV inverter controller directly receives the broadcast request from the utility:**
 - a. **The PV inverter controller determines internally how best to respond,** and performs those actions.
 - b. **The PV inverter controller may or may not respond** to the command from the utility with an acknowledge and any appropriate information.
 - If the utility does not expect a direct response, it may both monitor conditions to determine if enough power system changes have occurred and/or read the meter (or meter event log) to determine if the PV inverter responded appropriately.
 - If it does respond, it will acknowledge receipt of the command and returning the appropriate information.
6. **The PV inverter(s) are metered either individually or via net metering,** with their output (in response to the command) captured as part of the metering data. If electric storage is part of the PV system, then it could be metered separately or the PV system as a whole could just be metered. (Metering is out of scope for this document).
7. **If communications are lost, the PV inverter goes to a default mode,** possibly after a timeout period. The default mode, the timeout period, and other parameters for this situation would be established ahead of time.

8. **Customers can override or modify commands**, at any time if they desire.

1.6 Levels of Compliance with this Specification

There will be different levels of compliance with this specification:

- Level 1 will include all PV Modes and Functions 1, 2, 3, 5, 6, 7
- Level 2 will add Schedules and Function 4.

2. Control Functions for PV Inverters

2.1 Basic Control PV Inverter Functions

Basic control functions assume a tightly coupled interaction between the PV inverters and a controlling entity (utility, energy service provider, or Customer EMS). This implies that the controlling entity has knowledge about the capabilities of the PV inverters, can request updates on their current status, can expect the PV inverter to follow the command to the best of their capabilities, and will receive a direct response from the PV inverters on the results from following the command.

Basic commands will supersede each other and any PV Mode commands in effect, based on the time they were issued by the controlling entity.

Basic commands also imply communication channels with high availability between the controlling entity and the PV inverters, since the controlling entity must maintain direct knowledge of the PV inverter status and capabilities. Nonetheless, it is expected that PV inverters will revert to “default” states if communications are unavailable for some pre-specified length of time (implementation dependent).

It is expected that, in general, utilities will use direct controls with larger, utility-owned PV inverters, while ESPs could use direct commands with groups of PV inverters, and Customer EMSs could use direct controls with those PV inverters belonging to the customer. However, other interactions are possible, depending upon business decisions and specific implementations.

2.1.1 *Function PC1: Connect / Disconnect from Grid*

This function causes the PV inverter to immediately physically connect or disconnect from the grid via a disconnect switch at the PV inverter’s ECP to the grid.

The utility/ESP or the Customer EMS takes the following actions:

1. **(Optional) Request status of PV inverter:** Request a pre-defined set of the status information, including the status values, the quality flag, and the timestamp of the status (see Function PC6 for details of status points).
2. **Issue Connect/Disconnect Command to PV inverter:**
 - a. Binary command to open or close a switch.
 - b. Time window within which to randomly execute the command. If the time window is zero, the command will be executed immediately (optional – if not included, then default time window for this function will be used)
 - c. Timeout period, after which the PV inverter will revert to its default status, such as closing the switch to reconnect to the grid (optional – if not included, then default timeout period for this function will be used)
3. **Receive response to the command:**
 - a. Successful (plus resulting switch position)

- b. Rejected (plus reason: equipment not available, message error, overridden, security error)

2.1.2 Function PC2: Adjust Maximum Generation Level Up/Down

This function sets the maximum generation level at the electrical coupling point (ECP) as a percentage of nameplate capacity. This limitation could be met by limiting PV output or by using the excess PV output to charge associated storage.

In addition, a ramp rate (power versus time) and a delay time before starting will be included so that not all PV inverters change state abruptly at the same time.

A timeout period is included for reverting to the default state of the PV inverter, to ensure that a missed or lost command does not impact normal operations beyond that timeout period.

The utility/ESP or the Customer EMS takes the following actions:

1. **(Optional) Request status of PV inverter:** Request a pre-defined set of the status information, including the status values, the quality flag, and the timestamp of the status (see Function PC6 for details of status points).
2. **Issue command to adjust power setpoint:**
 - a. Command to adjust the power setpoint to the requested generation level
 - b. Requested ramp time for the PV inverter to move from the current setpoint to the new setpoint if either it is now being constrained or it is now being released from a constraint (optional – if not included, then use previously established default ramp rate)
 - c. Time window within which to randomly execute the command. If the time window is zero, the command will be executed immediately, (optional – if not included, then default time window for this function will be used)
 - d. Timeout period, after which the PV inverter will revert to its default status, such as resetting the maximum power setpoint to its default value (optional – if not included, then default timeout period for this function will be used)
3. **Receive response to the command:**
 - a. Successful (plus actual maximum power setpoint)
 - b. Rejected (plus reason: equipment not available, message error, overridden, security error)

2.1.3 Function PC3: Adjust Power Factor

Fixed power factor will be managed through issuing a power factor angle value. In addition, a ramp rate (angle versus time) and a delay time before starting will be included so that not all PV inverters change state abruptly or at the same time.

A timeout period is included for reverting to the default state of the PV inverter, to ensure that a missed or lost command does not impact normal operations beyond that timeout period.

The utility/ESP or the Customer EMS takes the following actions:

1. **(Optional) Request status of PV inverter:** Request a pre-defined set of the status information, including the status values, the quality flag, and the timestamp of the status (see Function PC6 for details of status points).
2. **Issue command to adjust power factor setpoint:**
 - a. Command to adjust the power factor angle
 - b. Requested ramp time for the PV inverter to move from the current setpoint to the new setpoint (optional – if not included, then use previously established default ramp rate)
 - c. Time window within which to randomly execute the command. If the time window is zero, the command will be executed immediately, (optional – if not included, then default time window for this function will be used)
 - d. Timeout period, after which the PV inverter will revert to its default status, such as resetting the power factor setpoint to its default value (optional – if not included, then default timeout period for this function will be used)
3. **Receive response to the command:**
 - a. Successful (plus actual output power factor value)
 - b. Rejected (plus reason: equipment not available, message error, overridden, security error)



2.2 PV/Storage Functions

Both autonomous and directly managed PV/Storage systems (see Section 1.3) require object modeling standards for their interactions with external systems, but only the directly managed PV/Storage system will need object modeling standards for direct interactions.

It is understood that PV/Storage systems will always be in ultimate control of what they do and that these functions are “requests” to perform certain actions if feasible within pre-specified constraints. For example, a storage system cannot charge when the storage element is full nor can it discharge if at the storage reserve limit.

2.2.1 *Function PC4a: Request Real Power (Charge or Discharge Storage)*

This function requests the storage system to charge or discharge and at what rate (% of max charging rate). A controller might use this command frequently, in conjunction with reads of the battery charge level, to achieve a desired daily charge / dump characteristic.

To account for diversity in the size of storage systems, the function requests a percentage quantity based on the capacity of the system. For real power out requests (storage discharging), the percent is relative to the maximum discharge rate (inverter capacity). For real power in requests (storage charging), the percent is relative to the maximum charging rate (battery charger capacity). It is acknowledged that the discharging capacity of the inverter and the charging capacity of the charger may differ.

A timeout period is included for reverting to the default state of the PV inverter, to ensure that a missed or lost command does not impact normal operations beyond that timeout period.

The PV/Storage system may also determine if only PV inverter output is used for charging or whether grid power can be used.

The utility/ESP or the Customer EMS takes the following actions:

1. **(Optional) Request status of PV/Storage system:** Request a pre-defined set of the status information, including the status values, the quality flag, and the timestamp of the status (see Function PC6 for details of status points).
2. **Issue command to request real power (charge/discharge) setpoint for the storage system:**
 - a. Command to adjust the real power charge/discharge setpoint for the storage system
 - b. Requested ramp time for the PV/storage system to move from the current setpoint to the new setpoint (optional – if not included, then use previously established default ramp rate)
 - c. Time window within which to randomly execute the command. If the time window is zero, the command will be executed immediately, (optional – if not included, then default time window for this function will be used)
 - d. Timeout period, after which the PV/Storage system will revert to its default status (optional – if not included, then default timeout period for this function will be used)
 - e. Storage charge from grid setting (yes/no)
3. **Receive response to the command:**
 - a. Successful (plus actual real power setpoint)
 - b. Rejected (plus reason: equipment not available, message error, overridden, security error)

2.2.2 Function PC4b: Provide Pricing Signal

This function provides a pricing signal (actual price or some relative pricing indication) from which the PV/Storage system may decide whether to charge the storage or discharge the storage, and what rate to charge or discharge.

The utility/ESP or the Customer EMS takes the following actions:

1. **Issue pricing signal (*the actual form or content of the pricing signal will be established by the utility/ESP and is outside the scope of this specification*):**
 - a. Pricing signal
 - b. Requested ramp time for the PV/storage system to move from its current output to any new output (optional – if not included, then use previously established default ramp rate)

- c. Time window within which to randomly execute the command. If the time window is zero, the command will be executed immediately, (optional – if not included, then default time window for this function will be used)
- d. Timeout period, after which the PV/Storage system will revert to its default status (optional – if not included, then default timeout period for this function will be used)

2. **Receive response to the command:**

- a. Successful (plus actual real power setpoint)
- b. Rejected (plus reason: equipment not available, message error, overridden, security error)

2.2.3 *Function PC4c: Modify PV/Storage Settings*

This function permits the utility, energy service provider, customer EMS, and/or other authorized entities to dynamically modify or update various parameters for PV/Storage systems. This list of parameters may be expanded, but will include:

- **Intermittency Ramp Rate Limit.** This setting will limit the rate that watts delivery to the grid can increase or decrease in response to intermittent PV generation. The configuration will be in units of “percent of name-plate rating per minute”. A single setting will be applied to both increasing and decreasing power output. This ramp rate limit does not apply to output power changes in-response to commands that are received. Such commands contain their own ramp limits. PV/Storage systems must manage the details of their battery charging such that the rate of change in power delivery to and from the grid remains below this limit – even when the PV generation is intermittent.
- **Storage Reserve** (Minimum energy charge level allowed, % of maximum charge level). This level may be set by the vendor, asset owner, or system operator for a variety of purposes. In some cases, depth of discharge may be limited in order to extend battery service life. In other cases, a minimum reserve may be desired to provide some carryover during outage. It is intended that reserve settings be maintained even while managing intermittency ramp rate limits as described above. For example, a system with a 20% minimum reserve setting may charge up to 40% before beginning to generate to the grid so that a sudden loss of the PV source can be covered by a controlled ramp-down of generation, and yet without dropping below 20% charge.
- **Maximum Generation/Discharge Level at the PV/Storage system.** This function is equivalent to PC2, but includes storage.
- Other?

The utility/ESP or the Customer EMS takes the following actions:

1. **(Optional) Request status of PV/Storage inverter:** Request a pre-defined set of the status information, including the status values, the quality flag, and the timestamp of the status (see Function PC6 for details of status points).
2. **Issue command to modify PV/Storage settings:**
 - a. Data element to be modified

b. New value for that data element

3. Receive response to the command:

- a. Successful (plus new value of data element)
- b. Rejected (plus reason: equipment not available, message error, overridden, security error)

2.3 Reporting Functions

2.3.1 Function PC5: Event/History Logging

2.3.1.1 Event Log Concepts

Event/history logs are maintained by the PV/storage systems to record key timestamped events in a “circular file” that will rollover itself as new events are added. The event log can be read by selecting time ranges, including “all”, “from time xx to time yy”, and “from time xx to the most recent event”. In addition, types of events can be filtered and selected using “event codes”. Once read, they could be further filtered by type of event or other criteria.

Different users of PV/Storage systems will need varying timeframes for retrieving event log information and different types of information from these event logs:

- Utility operations will typically only need key operations-related information, possibly infrequently or only under special circumstances.
- Owners/managers (including utility owners) will want more detailed information, probably periodically or after certain types of events.
- Energy management systems with tightly-coupled interactions will need complete event logs relatively frequently.
- Larger PV plants are different from large numbers of small PV systems: more types of event data may be collected from these larger plants, while only basic event data may be collected from the smaller PV systems. Larger plants may also aggregate and/or amalgamate events from multiple individual PV inverters.

Given this broad range of different requirements for event logs, this specification will define the following:

- Standard types of events that do not necessarily need to be implemented, but if they are implemented, then they will be implemented as specified, thus making them interoperable.
- Proprietary types of events can be implemented for specific implementations, specific vendors, regional requirements, etc. These will not be described in this specification, but will be left to those specific implementations to define. These will therefore not necessarily be interoperable.

These events will include standardized event codes. Different users can then retrieve specific types of events and also filter the event logs through these event codes.

In general it is expected that the following types of events will be logged, but decisions on exactly which ones are logged, which ones are retrieved by any specific user, will be determined on an implementation basis:

- All errors or failures
- All startup and shutdown actions
- All control actions
- All responses to control actions
- All limit violations, including returns within limits

2.3.1.2 Event Log Fields

All event logs will contain the following 5 fields:

1. **Date and time stamp:** The accuracy of this timestamp will be determined by the frequency of time synchronization and the innate precision in keeping time of the PV system, and is therefore outside the scope of this specification. Zeros can be used to pad any timestamp if the accuracy does not match the format.
2. **Data reference:** the reference to the data item that triggered the event log entry. For instance, if it is a voltage-related event, the Data reference will be to that data object. If it is a PV Mode event, the Data Reference will be to the PV Mode data object.
3. **Value:** Value field of the Data reference field that is triggering the event, including commands, state changes of monitored values, quality code changes, mode setting, etc. For instance, the request to go into a specific PV mode will be logged with the Value containing the PV mode identity.
4. **Event code:** 4-part code to uniquely identify the type of event – see **Table 1**.
5. **Optional text field:** Text of supporting information. This text will not be standardized, but can be used to provide additional details about the event.

To enable the filtering of events so that different users can select different types of events to retrieve, event “codes” are established. These event codes are based on the IEC 61968-9 (CIM for distribution) event codes, with additions as necessary to address inverter events. The Event Code standard contains many codes, with only a small fraction relevant to PV/Storage systems. The more important ones (including additional ones) are described in Table 1 below, but different implementations may choose different sets of event types, including vendor-specific and/or implementation-specific event types.

The codes are built from 4 levels: Domain, Part, Type, and Attribute. In this Specification, four existing Domains are used:

- Communications (for communication-related events)
- Grid power (for power system events)
- Device asset (for time and asset-related events)
- Security (for security-related events)

Two new domains are defined:

- PV system (for PV inverter events, as well as other PV events)
- Storage system (for storage inverter events, as well as other storage events)

In the table below, the Storage system, if separate from the PV System, would have the same event codes except for changing “PV System” to “Storage System” with a D# code of 22.

Table 1: Event Codes

Domain	D#	Part	P#	Type	T#	Attribute	A#	Description
Communications	01	Messaging	19	Status	17	Success	244	Request received successfully. Value field identifies the request as a “demand response”
Communications	01	Messaging	19	Status	17	Success	244	Command received successfully. Value field identifies the command as a “Direct command”
Communications	01	Messaging	19	Status	17	Acknowledged	3	Response – acknowledgment sent
Communications	01	Messaging	19	Alarm	1	Message failed	156	Response – alarm invalid message. Value field contains type of error.
Communications	01	Network interface	23	Alarm	1	Comm. failed	32	Alarm communications error. Value field contains type of error.
PV System	21	Inverter	51	Command	6	Success	244	Action taken successfully (details are provided in Mode and Command events)
PV System	21	Inverter	51	Command	6	Failed	85	Requested action failed. Value field contains type of error.
PV System	21	Inverter	51	Command	6	Deviation	65	Action taken is a deviation from the requested action. Data Reference and Value fields contain indication of this deviation
PV System	21	Mode	22	Status	17	PV Mode	302	Inverter is in one of the PV modes, as indicated in the Value field
PV System	21	Inverter	51	Command	6	PC Command	303	Inverter responded to one of the PC commands, as indicated in the Value field
PV System	21	Inverter	51	Status	17	Limit exceeded	139	Inverter status changed due to internal control threshold exceeded. Data Reference and Value fields provide details
PV System	21	Schedule	52	Schedule change	31	Success	244	Action was successfully taken in response to the scheduled requirement

PV System	21	Schedule	52	Schedule change	31	Failed	85	Action failed in response to the scheduled requirement. Value field indicates the type of error
PV System	21	Power	26	Status	17	Power out	185	Inverter power turned off
PV System	21	Power	26	Status	17	Power on	216	Inverter power turned on
PV System	21	Power	26	Alarm	1	Power out	185	Power tripped off due to internal situation
PV System	21	Power	26	Alarm	1	DC voltage	301	Inadequate DC bus voltage, Value field provide measured value
PV System	21	Power	26	End alarm	9	DC voltage	301	DC bus voltage within limits. Value field provide measured value
PV System	21	Temperature	35	Alarm	1	Limit exceeded	139	Temperature limit exceeded. Value field contains type of error.
PV System	21	Temperature	35	End alarm	9	Limit exceeded	139	Returned within temperature limit. Value field contains type of error.
Grid Power	6	ECP Switch	31	Status	17	Connected	42	Switch at the ECP between inverter and the grid is connected
Grid Power	6	ECP Switch	31	Status	17	Disconnected	68	Switch at the ECP between inverter and the grid is connected
Grid Power	6	Voltage	38	Alarm	1	Limit exceeded	139	Voltage limit exceeded. Value field contains voltage measurement.
Grid Power	6	Voltage	38	End alarm	9	Limit exceeded	139	Returned within voltage limit. Value field contains voltage measurement.
Grid Power	6	Voltage	38	Alarm	1	Limit exceeded	139	Voltage distortion limit exceeded. Value field contains voltage distortion.
Grid Power	6	Voltage	38	End alarm	9	Limit exceeded	139	Returned within voltage distortion limit. Value field contains voltage distortion.
Grid Power	6	Current	6	Alarm	1	Limit exceeded	139	Current limit exceeded. Value field contains current measurement.
Grid Power	6	Current	6	End alarm	9	Limit exceeded	139	Returned within current limit. Value field contains current measurement.

Grid Power	6	Power quality	28	Alarm	1	Limit exceeded	139	Harmonic limit exceeded. Value field contains harmonic measurement.
Grid Power	6	Power quality	28	End alarm	9	Limit exceeded	139	Returned within harmonic limit. Value field contains harmonic measurement.
Grid Power	6	Other 1547 parameters??		Alarm	1	Limit exceeded	139	?? limit exceeded
Grid Power	6	Other 1547 parameters??		End alarm	9	Limit exceeded	139	Returned within ?? limit
Device asset	2	Logs	17	Status	17	Almost full	8	Log is almost full. Value contains percentage full.
Device asset	2	Logs	17	Alarm	1	Full	304	Log full: new events to overwrite unread events
Device asset	2	Time	36	Alarm	1	Clock failed	29	Clock failure. Value contains error information.
Device asset	2	Time	36	Alarm	1	Synch failed	252	Synchronization failed. Value contains error information
Device asset	2	Time	36	Setting	16	Synchronized	254	Synchronized. Value contains delta between new time and old time
Device asset	2	Time	36	Setting	16	Daylight adjust	254	Daylight time or Standard time adjustment. Value indicates Daylight of Standard
Device asset	2	Firmware	11	Alarm	1	Data error	52	Data error detected in firmware. Value indicates type of error

The retrieval of the event log consists of the following command and response:

1. Retrieve event log

- a. Event log retrieval command
- b. Retrieval criteria: event codes to be retrieved, with “wildcard” capabilities
- c. Start time/ stop time (start time = 0 means start from beginning of log; stop time = 0 means include through the final log entry)

2. Receive response to the command:

- a. Requested log entries
- b. Success/Failure (plus reason: no log event fulfills the retrieval criteria, log not available, message error, security error, request type not supported, etc.)

Additional event log interactions can include:

- Notification if event log is almost full or completely full without having been retrieved
- Notification of an event log error

2.3.2 Function PC6: Status Reporting

Many functions require the status of the PV inverter either periodically, on significant change of a value, or upon request. How different protocols may implement these reporting requirements is outside the scope of these specifications, but as a minimum, reporting status upon request is mandatory.

For these specifications, it is also assumed that “nameplate” or other relatively static data will initially be provided “manually” via an electronic setup file. However, any settable data should also be readable upon request – the list of that data will be implementation and/or vendor specific, but should utilize existing standards where possible.

All status items are optional. However, if implemented, then they should use the standard.

The following status data is standardized:

Status Point	Description
Primary information	
Connect status	Whether or not the device is currently connected at its ECP.
PV output available	Yes/No
Storage output available	Yes/No
Status of var capability	Yes/No
Inverter active power output	Present real power output level (Watts). This is an instantaneous (minimum averaging) reading.
Inverter reactive output	Present reactive power output level (Vars, leading or lagging). This is a signed quantity.
Current PV Mode	Identity of mode or function that the PV/Storage is in, including “owner mode” (Enumeration with range left open for proprietary vendor)

Detailed information	
Inverter status	Inverter is switched on (operating), off (not able to operate), or in stand-by mode (capable of operating but currently not operating)
DC Current level available for operation	Indicates whether or not there is sufficient DC current to allow operation. – Value, not yes/no
Inverter active power output	Present real power output level (Watts). This is an instantaneous (minimum averaging) reading.
DC inverter input power	Use for determining efficiency of inverter
Local/Remote control mode	Inverter is under local control or can be remotely controlled
Real power setpoint	Value of the real power setpoint
Reactive power setpoint	Value of the output reactive power setpoint
Power factor setpoint	Value of the power factor setpoint as angle
Frequency setpoint	Value of the frequency setpoint
Power measurements	
Active power	Active power value, plus high and low limits
Reactive power	Reactive power value, plus high and low limits
Phase to ground voltages	Voltage values per phase, plus high and low limits
Power factor	Power factor value, plus high and low limits
Battery storage status (if storage is included in PV system)	
Capacity rating	The useable capacity of the battery, maximum charge minus minimum charge from a technology capability perspective (Watt-hours)
State of charge	Currently available energy, as a percent of the capacity rating (percentage)
Available energy	State of charge minus storage reserve (Watt-hours) See storage settings section for definition of “storage reserve”
Maximum battery charge rate	The maximum rate of energy transfer into the storage device. (Watts) This establishes the reference for the charge percentage settings in function PC4a.
Maximum battery discharge rate	The maximum rate of energy transfer out of the storage device (Watts) This establishes the reference for the discharge percentage settings in function PC4a.
Internal battery voltage	Internal battery voltage
DC inverter power input	Used for determining efficiency of inverter
Nameplate and Settings Information	
Manufacturer name	Text string
Model	Text string
Serial number	Text string
Inverter power rating	The continuous power output capability of the inverter (Watts)
Inverter VA rating	The continuous Volt-Amp capability of the inverter (VA)
Inverter VAR rating	Maximum continuous Var capability of the inverter (Var)
Maximum battery charge rate	The maximum rate of energy transfer into the storage device. (Watts) This establishes the reference for the charge percentage settings in function PC4a.
Maximum battery discharge rate	The maximum rate of energy transfer out of the storage device. (Watts) This establishes the reference for the discharge percentage settings in function PC4a.
Storage present indicator	Indication of whether or not battery storage is part of this system.

PV present indicator	Indication of whether or not PV is part of this system.
Time resolution	Time resolution and precision
Source of time synchronization	Text string

The retrieval of status items may be undertaken using one or all of the following methods:

- Single status values:
 - On-demand, request a single status value. That status value will then be returned to the requester.
 - Upon a status value change or upon exceeding a deadband or upon exceeding a limit (depending upon the type of status point), that status value will be transmitted
- Sets of status values:
 - During initialization of the PV/Storage system, sets of status values can be assigned to one or more “data sets”. These data sets can then be used in the following ways:
 - On-demand, request one of these data sets. All of the status values in the requested data set will be returned to the requester
 - Periodically, all of the status values in each data set will be transmitted
 - Upon change or upon exceeding a deadband or upon exceeding a limit of a status point in the data set, all of the status values in the affected data set will be transmitted
 - After initialization, using the communications network, data sets can be created, modified, and/or deleted, and the reporting triggers can be established (e.g. upon demand, periodically, upon change).

The “on-demand” retrieval method for a single status values and at least one data set are mandatory. The other retrieval methods may be optional or may be deemed mandatory for different implementations.

In the “on-demand” retrieval method, the following command and response actions are used:

1. **“On-demand” status**
 - a. Status command
 - b. Identity of which status value or which data set
2. **Response to on-demand:**
 - a. Requested status value(s)
 - b. Timestamp
 - c. Quality of status value(s)
 - d. Failed (plus reason : equipment not available, message error, security error)

For the other retrieval methods, the following “unsolicited” information is transmitted:

1. **Periodic or upon change of a status value:**
 - a. Status value(s)

- b. Timestamp
- c. Quality of status value(s)

2.4 Periodic Commands

2.4.1 *Function PC7: Time Synchronization*

The PV inverter will use of Network Time Protocol (NTP) (RFC-1305) or Simple Network Time Protocol (SNTP) (RFC 1305) between the “customer EMS” and the PV inverter to set time.

2.5 VAR Modes for Decentralized Var Support from PV/Storage Inverters

2.5.1 VAR Management Modes and Volt/Var Arrays (SubModes)

Since utilities (and/or other energy service providers) will be requesting var support from many different PV inverters with different capabilities, different ranges, and different local conditions, it would be very demanding of the communications systems, unnecessary, and ultimately impossible for the utilities to issue explicit settings to each PV inverter every time a change is desired.

PV Modes and SubModes: Therefore, some examples of PV Modes have been established (*see Modes PVI – PV4*) for typical types of var support requests. For each PV mode, one to a few volt/var arrays of settings (termed SubModes) can be associated. Each volt/var array consists of volt/var pairs: a set of voltage levels and their corresponding var levels that will be treated as a piecewise linear function. These arrays can be of variable length, depending upon the number of volt/var pairs. Utilities can issue these volt/var array SubModes initially and update them when necessary.

Invoking PV Modes: There are three ways a utility can invoke a PV Mode and its SubMode:

- Direct requests to specific PV inverters
- Broadcasts or multicasts to all PV inverters in a selected area (region, feeder, substation) to use a particular volt/var array.
- Scheduling PV Modes and SubModes using different criteria.

Requested PV Modes will remain in effect until superseded by another requested PV Mode.

Loosely coupled actions: PV Mode requests to PV inverters are examples of decentralized coordination of generation or loosely-coupled generation control. These are characterized by “request signals” rather than “explicit commands” sent to generation sources. The difference is that “request signals” may or may not be followed due either to limitations of the equipment (or sunlight) or to customer decisions; while “explicit commands” must be followed.

These SubMode volt/var arrays and the PV Modes are not explicit for a particular PV inverter or even type or size of PV inverter, but are focused on requesting all PV inverters to provide the needed var support as best as their capabilities allow them. For instance, PV inverters may not be able to respond for any number of reasons: the sun is not shining, the customer has overridden the mode setting, local situations are impacting what response the PV inverter can provide, etc. Therefore the utility is expecting to get an aggregated response from many or most PV inverters, but not all. Any financial ramifications will be determined by the metering results.

Since these mode requests maybe broadcast to specific groups of PV inverters and since the responses from the PV inverters will generally not be explicit, the utility may not know what the actual responses will end up being, and could require subsequent interactions not only with these PV inverters but possibly with distribution grid capacitor controllers, load tap changers, voltage regulators, storage devices, and other types of DER.

Randomized response times: For broadcast PV Mode requests, since the mode requests will (most likely) be broadcast to large numbers of PV inverters at the same time, it may be necessary to stagger the responses by the PV inverters and/or allow local conditions to dictate whether they respond at all. This is the same issue as load control systems have dealt with for many years, so many of the same solutions may be applicable.

Ramp rate: In addition to the volt/var settings, a ramp rate (the time in seconds required for the inverter to reach 63% of the demanded var output (RC time constant)) or a randomization interval (time window, in seconds, during which the inverter would randomly initiate the identified actions) would be provided to smooth and stabilize the responses of large numbers of PV inverters.

IEEE 1547: This specification addresses PV Modes that operate only within the “IEEE 1547 Green Zone”. Therefore for informational purposes, the following definitions are used:

- V_{min} is the IEEE 1547 minimum voltage level of 88% of nominal voltage where the PV inverter must disconnect.
- V_{max} is the IEEE 1547 maximum voltage level of 110% of nominal voltage where the PV inverter must disconnect.
- Q_{max} is the inverter’s current var capability and may be positive (capacitive) or negative (inductive). It would be the kVA capability left after supporting the kW demand.

Key PV Modes are described below, with the understanding that additional modes may be defined at a later date. In any of these modes, the PV inverter would still be limited to what it can safely or physically provide, and will log its actions.

Timeout period: A timeout period is included for reverting to the default state of the PV inverter, to ensure that a missed or lost command does not impact normal operations beyond that timeout period.



2.5.2 VAR Mode PV1: Normal Energy Conservation Mode

The Normal Energy Conservation mode reflects the utility’s calculation of the most efficient and reliable var levels for PV inverters at specific distribution points of common coupling (PCC). This mode could also help compensate for local high voltage due to PV kW back flow on the circuit.

In this mode, PV inverters will be provided with a double array of setpoints: a set of voltage levels and their corresponding var levels. The voltage levels will range between V_1 and V_2 in increasing voltage values. Values between these setpoints will be interpolated to create a piecewise linear volt/var function. The corresponding var levels would define the percent of Q_{max} (ranging between -100% and +100%) being requested for the voltage level.

The figure below is one example of volt/var settings for this mode. It is assumed that the var value between V_{min} and V_1 is the same as for V_1 (Q_{max} in this example). The equivalent is true for the var value between V_4 and V_{max} ($-Q_{max}$ in this example).

Mode PV1 – Normal Energy Conservation Mode

Example Settings

Voltage Array		VAR Array (%)	
V1	115	Q1	100
V2	118	Q2	0
V3	122	Q3	0
V4	126	Q4	-100

VAR Ramp Rate Limit – fastest allowed change in VAR output in response to either power or voltage changes	50 [%/second]
Randomization Interval – time window over which mode or setting changes are to be made effective	60 seconds

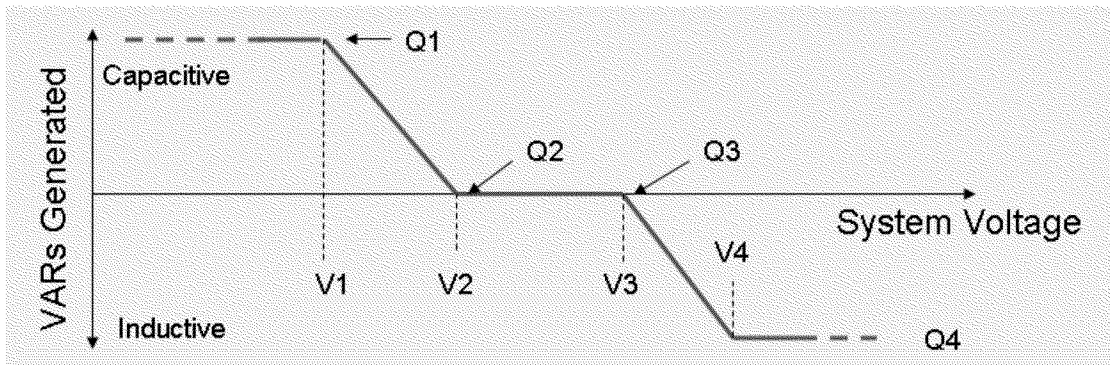

1. Issue request to go into PV1 Mode:

- a. Request to go into PV1 Mode
- b. Array of volt/var of setpoints (optional – if not included, then use previously established default array)
- c. Requested ramp time for the PV inverter to move from the current setpoint to the new setpoint if either it is now being constrained or it is now being released from a constraint (optional – if not included, then use previously established default ramp rate)
- d. Time window within which to randomly execute the command. If the time window is zero, the command will be executed immediately, (optional – if not included, then default time window for this function will be used)
- e. Timeout period, after which the PV inverter will revert to its default status, such as resetting the maximum power setpoint to its default value (optional – if not included, then default timeout period for this function will be used)

2.5.3 VAR Mode PV2: Maximum Var Support Mode

In this mode, PV inverters provide maximum vars currently available (Q_{max} available = 100%) without reducing kW output or exceeding V_{max} . This mode would typically be invoked by the utility to support transmission var emergencies.

This function would essentially be represented as a straight horizontal line at $Q_{max} = 100\%$, until the IEEE 1547 low voltage limit or ANSI C84.1 high voltage limit is reached or the inverter protective limits are hit (although the actual var value of Q_{max} itself could vary at different voltage levels).

The figure below provides one example of how a PV2 mode may be configured. In this example, the inverter generates maximum capacitive vars for reduced voltages down to the cutoff limit V_{min} . As voltage increases above configuration point $V1$, var generation is ramped down, reaching zero at $V2$, so as not to drive the local system voltage too high.

The ramp rates and/or the randomized time-constant settings are also required.

Mode PV2 – VAR Support Mode

Example Settings

Voltage Array		VAR Array (%)	
V1	122	Q1	100
V2	126	Q2	0

VAR Ramp Rate Limit – fastest allowed change in VAR output in response to either power or voltage changes	50[%/second]
Randomization Interval – time window over which mode or setting changes are to be made effective	60 seconds

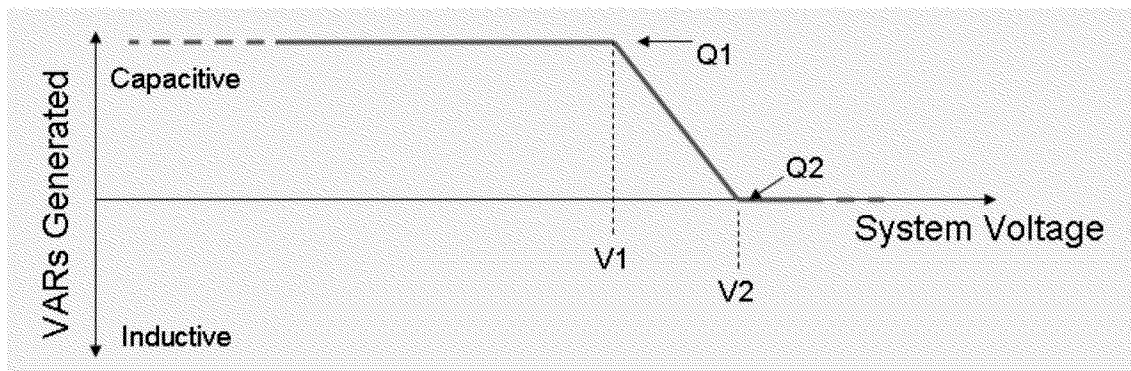

1. Issue request to go into PV2 Mode:

- a. Request to go into PV2 Mode
- b. Array of volt/var of setpoints (optional – if not included, then use previously established default array)
- c. Requested ramp time for the PV inverter to move from the current setpoint to the new setpoint if either it is now being constrained or it is now being released from a constraint (optional – if not included, then use previously established default ramp rate)
- d. Time window within which to randomly execute the command. If the time window is zero, the command will be executed immediately, (optional – if not included, then default time window for this function will be used)

- e. Timeout period, after which the PV inverter will revert to its default status, such as resetting the maximum power setpoint to its default value (optional – if not included, then default timeout period for this function will be used)



2.5.4 VAR Mode PV3: Static Var Mode

In this mode, inverters will be set with fixed var settings.

This function can be typically represented as a straight horizontal line at a Q percentage value between +/-100% until the IEEE P1547 Vmin/Vmax levels or the inverter protective limits are reached. It is distinguished from mode PV4 only in that the Var level is assumed to be non-zero.

This mode is likely to be of interest in cases where a separate PV system controller is managing the PV site. In such a case, the controller would be the point of intelligence, monitoring system voltage and communicating with the utility, then managing the local inverters moment by moment to achieve the desired results.

The figure below illustrates a case where mode PV3 is configured using two voltage points with the same var setting for each. This results in a flat var generation across the entire inverter operating range because of the previously defined flat behavior above the highest voltage configuration point and below the lowest.

The ramp rates and/or the randomized time-constant settings are also required.

Mode PV3 – Fixed VAR Mode (VAR % setting determined by an entity outside the inverter)

Example Settings

Voltage Array		VAR Array (%)	
V1	115	Q1	50
V2	125	Q2	50

VAR Ramp Rate Limit – fastest allowed change in VAR output in response to either power or voltage changes	50[%/second]
Randomization Interval – time window over which mode or setting changes are to be made effective	60 seconds

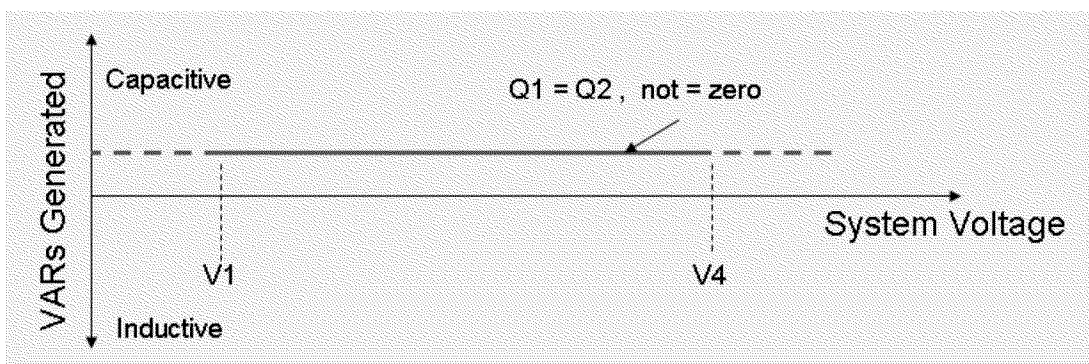

1. Issue request to go into PV3 Mode:

- a. Request to go into PV3 Mode
- b. Array of volt/var of setpoints (optional – if not included, then use previously established default array)
- c. Requested ramp time for the PV inverter to move from the current setpoint to the new setpoint if either it is now being constrained or it is now being released from a constraint (optional – if not included, then use previously established default ramp rate)
- d. Time window within which to randomly execute the command. If the time window is zero, the command will be executed immediately, (optional – if not included, then default time window for this function will be used)
- e. Timeout period, after which the PV inverter will revert to its default status, such as resetting the maximum power setpoint to its default value (optional – if not included, then default timeout period for this function will be used)



2.5.5 VAR Mode PV4: Passive Mode

This mode is the same as mode PV3 above, except that the var levels are zero. Although managing the configuration of this mode using a volt/var array is overkill, it is used here for consistency with other modes. Any attempt to configure mode PV3 with non-zero var levels will result in an error response.

In this mode, inverters will follow the system voltage levels within their capability range, presumably at their most efficient settings. This would be the same as current UL 1741/IEEE 1547 compliant product.

This mode will serve as the default mode for PV inverters upon power up, when schedules expire, or if no communications have been received within a defined period. (e.g. if no additional signals have been received over x hours or if the schedule has run out without further updates).

Utilities could switch some or all inverters to this mode if other modes presented unexpected difficulties.

1. Issue request to go into PV4 Mode:

- a. Request to go into PV4 Mode
- b. Array of volt/var of setpoints (optional – if not included, then use previously established default array)
- c. Requested ramp time for the PV inverter to move from the current setpoint to the new setpoint if either it is now being constrained or it is now being released from a constraint (optional – if not included, then use previously established default ramp rate)

- d. Time window within which to randomly execute the command. If the time window is zero, the command will be executed immediately, (optional – if not included, then default time window for this function will be used)
- e. Timeout period, after which the PV inverter will revert to its default status, such as resetting the maximum power setpoint to its default value (optional – if not included, then default timeout period for this function will be used)

3. Scheduled Actions

3.1 Scheduling Using Different Bases: Time, Temperature, Pricing Signals

Larger PV systems and large aggregations of small PV systems have significant influence on the distribution system and have local volt/var characteristics that may vary throughout the day. As a result, a single volt/var configuration may not be suitable at all times. Sending many control commands may impact the communications system or may not be received in a timely manner, leading to inadequate PV system responses. However, if schedules can be established that the PV systems can follow autonomously, then these communication impacts can be minimized.

Therefore, in addition to direct control or broadcast/multicast requests, utilities and/or ESPs could send out schedules to individual and/or large groups of PV inverters, based on time, temperature, pricing signal, or possibly other criteria. This method allows more autonomous control with less tightly-coupled coordination, while requiring fewer interactions.

For var support actions, PV inverters could act in a similar manner to feeder capacitor banks, changing var settings based on a time schedule and/or temperature. This capability would most likely be used with larger installations of PV inverters, for instance at a PV inverter farm, where the utility could manage the PV inverters as part of primary feeder volt/var schemes. The reason for this mode is that voltage sensed by these large inverters will differ from that sensed by nearby customers due to voltage drop on transformers and secondaries. This is the same problem with voltage switched capacitor banks.

These schedules can be used as follows:

1. Initially, and as needed over time, the utility or ESP issues volt/var arrays (SubModes) for each of the PV Modes that could be used in schedule (up to a limit of arrays determined during implementation).
2. These schedules consist of base/mode arrays: with pairs of the base (times or temperatures) linked to these PV Modes and SubModes.

Three types of schedules are covered in this specification (although others could be developed later): time-based and temperature-based. The three schedule types are:

1. **Time-based Scheduling:** The PV/Storage inverter may be sent a variable-length array of times (t) in seconds (e.g. t0= 0; t1=7200, t2=36,000, etc.) with a Mode and SubMode associated with each time. This time-based schedule uses relative time, so that all times (t) are added to some start time (e.g. if start time is 6:00 am, then t0 = 6 am, t1 = 8 am, t2 = 4 pm). The PV inverter would follow this schedule indefinitely until some new command is received or power is cycled.
2. **Temperature-based Scheduling:** If the PV installation has access to ambient temperature readings either locally or provided by the utility, the schedule of Modes/SubModes could be temperature-based. The schedule would then consist of pairs of temperature and associated PV Mode and SubMode.

3. **Pricing Signal-based Scheduling:** The PV/Storage may be sent a variable-length array of pricing signals with a Mode and SubMode associated with each pricing signal. Then whenever a pricing signal is broadcast, the PV/Storage system would transition to the appropriate Mode/Submode.

3.2 Scheduling for Charging / Discharging in PV/Storage Systems

This is a scheduled version of the “Request Real Power” function. By sending a schedule to a device for charging and discharging, as opposed to immediate settings, the burden on the communication system may be reduced. The settings for this function are still a percentage (based on system capacity), just as with the “Request Real Power” message.

These schedules can be sent to Customer EMS and/or the PV/Storage systems as follows:

- During initialization of the interactions between the utility and the PV/Storage, the utility or ESP issues one or more default PV/Storage schedules (up to a limit of schedules determined during implementation). This allows subsequent commands to just be “Start schedule 1” or “Start schedule *Peak Shave*” without having to resend the schedule.
- These PV/Storage schedules can be updated as necessary over time.
- These schedules consist of multi-column arrays of variable length (up to a maximum determined during implementation):
 - 1st column: **Value** – Real power (percentage of nominal) at ECP
 - 2nd column: **Basis** – time, temperature, pricing signal, or other criteria
 - 3rd column: **Range** – range of time, temperature, pricing signal, or other criteria (range of time may be implicit, with the next “time” entry indicating the stop of the previous “time” entry)
 - 4th column: **Ramp** – ramp rate to move from one real power setting to another
- If Basis is time-based, the time will be relative to the start time of the schedule, which would be one of the parameters in the command from the utility/ESP.
 - The first time in the schedule would be 00:00, implying that the first value should be ramped to at the start time given in the “Start Schedule” command
 - The schedule can be stopped at its end or repeated: daily schedule, weekly schedule, etc.
- If Basis is temperature-based, it is assumed the PV/Storage has access to either local temperature or a broadcast temperature. Temperature ranges would need to be included in the schedule.
- If Basis is pricing signal-based, it is assumed that a broadcast of the pricing signal will be provided. Depending upon the type of pricing signal, ranges may or may not need to be provided.
- “Start Schedule” command: the request for the PV/Storage to start a schedule includes:
 - Start schedule = xxx (identity of schedule)

- Start time = yy:mm:dd, hh:mm:ss
- Repeat/Do not repeat Schedule at yyy interval (e.g. daily)

3.3 Scheduling Var Modes

Schedules for Var Modes are more complex because the modes themselves are arrays of volt/var pairs. Therefore the 1st column Value would be the combination of the Mode and the identity of the volt/var array.

- These schedules consist of multi-column arrays of variable length (up to a maximum determined during implementation):
 - 1st column: **Value** – Volt/Var Mode and identity of volt/var array
 - 2nd column: **Basis** – time, temperature, pricing signal, or other criteria
 - 3rd column: **Range** – range of time, temperature, pricing signal, or other criteria (range of time may be implicit, with the next “time” entry indicating the stop of the previous “time” entry)
 - 4th column: **Ramp** – ramp rate to move from one real power setting to another
- If Basis is time-based, the time will be relative to the start time of the schedule, which would be one of the parameters in the command from the utility/ESP.
 - The first time in the schedule would be 00:00, implying that the first value should be ramped to at the start time given in the “Start Schedule” command
 - The schedule can be stopped at its end or repeated: daily schedule, weekly schedule, etc.
- If Basis is temperature-based, it is assumed the PV/Storage has access to either local temperature or a broadcast temperature. Temperature ranges would need to be included in the schedule.
- If Basis is pricing signal-based, it is assumed that a broadcast of the pricing signal will be provided. Depending upon the type of pricing signal, ranges may or may not need to be provided.
- “Start Schedule” command: the request for the PV/Storage to start a schedule includes:
 - Start schedule = xxx (identity of schedule)
 - Start time = yy:mm:dd, hh:mm:ss
 - Repeat/Do not repeat Schedule at yyy interval (e.g. daily)

3.4 Scheduling Using Pricing Signals (or Value) of Energy

This is the scheduled version of the “Provide Pricing Signal” function. Pricing Signal Schedules use an absolute price or some relative value of energy to allow autonomous systems to decide what actions to take. The pricing signal may reflect the actual price of energy in a TOU, CPP or

dynamic pricing program, or it may be an abstract indicator of how the value of energy varies throughout the day or week.

The pricing signals in the schedule may be common across a wide geographical area, or may vary by location (Locational Marginal Pricing (LMP)), or may take into account specific substation or feeder requirements and/or constraints. Autonomous storage systems will apply this information to make decisions, likely in conjunction with other configuration and preference data, using vendor-specific methods to manage the actual charging and discharging of the storage element.

4. IEC 61850 Object Models for PV Inverters

{This section is still being updated – ignore it for now}

The object modeling requirements in this Specification will use existing and extended IEC 61850-7-420 (DER) Logical Nodes, as well as existing IEC 61850-7-4 (basic) Logical Nodes, IEC 61850-7-3 Common Data Classes, and IEC 61850-7-2 Services. All 61850-7-420 Logical Nodes exist, but a couple will need a few new data objects.

4.1 IEC 61850 Direct Commands

4.1.1 IEC 61850 Models for PC1: Connect/Disconnect

- CSWI: Open/close switch

4.1.2 IEC 61850 Models for PC2: Raise/Lower

1. **Request status of PV inverter:** Request a pre-defined set (DataSet) of the following data, including the value, the quality flag, and the timestamp of the value (see Function DC6)
2. **Issue command to adjust power setpoint:** After (optionally) assessing the PV inverter status and capabilities, issue the following command to adjust the power setpoint to the requested generation level:
 - a. *(Issue Maximum Generation Level command)*. **DOPM:** This DER controller logical provides settings for the operating mode at the ECP. This LN can be used to set available operating modes as well as to set actual operating modes. More than one mode can be set simultaneously for certain logical combinations.
 - Mode of operation – driven by energy source (e.g. solar, water flow) so generation level is constrained by availability of that energy source
 - Mode of operation – Output power as percentage of maximum
 - b. *(Establish settings for this command)* **DRCC:** The DER supervisory control logical node defines the control actions for one DER unit or aggregations of one type of DER device with a single controller.
 - Nominal ramp load or unload rate, power versus time (value, units)
 - Time delay before starting, with “step size” = random
 - RemTmm = Timeout for reverting to default state
3. **Receive response to the command:**
 - a. Successful (plus current Output power setpoint value)
 - b. Rejected (plus reason)
 - Unable to perform valid request

- Invalid request
- Feature not supported
- Value outside of range
- Error Information (Codes must be standardized)

4.1.3 IEC 61850 Models for PC3: Adjust Power Factor and/or Volt/Var Settings

The utility or Customer EMS would take the following actions.

1. **Request status of PV inverter:** Request DataSet of the following data, including the value, the quality flag, and the timestamp of the value (See Function 6)
2. **Issue command to adjust power factor:** After assessing the PV inverter status and capabilities, issue the following command to adjust the power factor:
 - a. ZINV
 - Output power setpoint
 - (And/or) Output reactive power setpoint
 - (Or) Power factor setpoint as angle
 - b. *(Establish settings for this command)* **DRCC:** The DER supervisory control logical node defines the control actions for one DER unit or aggregations of one type of DER device with a single controller.
 - Nominal ramp load or unload rate, power versus time (value, units)
 - Time delay before starting, with “step size” = random
 - RemTmm = Timeout for reverting to default state
3. **Receive response to the command:**
 - a. Successful (plus current Output power setpoint value)
 - b. Rejected (plus reason)
 - Unable to perform valid request
 - Invalid request
 - Feature not supported
 - Value outside of range
 - Error Information (Codes must be standardized)

4.2 IEC 61850 PV/Storage Commands

4.2.1 IEC 61850 Models for PC4: Control Energy Flow

IEC 61850-7-420 uses the concept of a Electrical Connection Point (ECP), which is defined as:

“The point of electrical connection between the DER source of energy (generation or storage) and any electric power system (EPS). Each DER (generation or storage) unit has an ECP

connecting it to its local power system; groups of DER units have an ECP where they interconnect to the power system at a specific site or plant; a group of DER units plus local loads have an ECP where they are interconnected to the utility power system.

NOTE For those ECPs between a utility EPS and a plant or site EPS, this point is identical to the point of common coupling (PCC) in the IEEE 1547 “Standard for Interconnecting Distributed Resources with Electric Power Systems”.

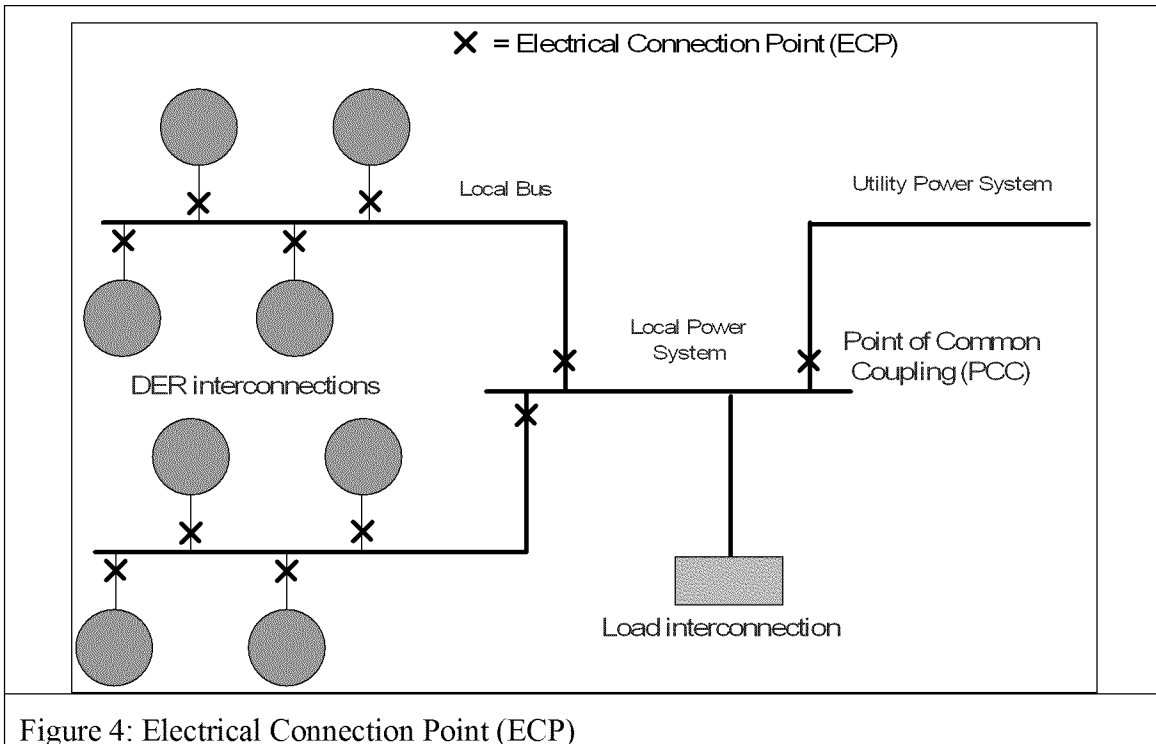

Figure 4: Electrical Connection Point (ECP)

The energy or price schedule will use existing IEC61850 scheduling mechanisms with:

- Array = Relative Time Schedule Array
- SchdTyp = 0 (Not Applicable / Unknown)
- SchdVal = 5 (Price for Active Power)
- A new mechanism added to allow for repeating schedules on at least daily and weekly intervals.

This message will use the existing IEC 61850-7-420....

<struggling to find an appropriate place for this in the existing standard. Neither the battery (ZBAT) or the battery charger (ZBTC) Logical Nodes seem to have a simple setting that could be used to manage power in/out of the battery as a percent of capacity. I think it would be undesirable to manage storage charging and discharging separately, using the ZINV and the ZBAT LNs. The existing model seems to view the battery as an emergency backup rather than for economic use.>

The PV inverter Customer EMS would take the following actions:

1. **Request status of PV inverter:** Request DataSet of the following data, including the value, the quality flag, and the timestamp of the value (See Function 6)
2. **Issue command to set net export/import level at the ECP:** After assessing the PV inverter status and capabilities, the PV inverter Customer EMS would issue the command to set the net export/import level of the PV inverter “system” at the ECP that includes both the PV system and the electric storage system. The PV inverter would be responsible for managing the flow of energy to and from the electric storage device to result in the requested net export/import level:
 - a. DRCC:
 - Setpoint for maintaining constant import/export energy at Electrical Connection Point (ECP)
 - Setpoint for maintaining fixed power factor: negative power factor is leading and positive power factor is lagging
 - RemTmm = Timeout for reverting to default state
3. **Receive response to the command:**
 - a. Successful (plus current Export/import setpoint value)
 - b. Rejected (plus reason)
 - Unable to perform valid request
 - Invalid request
 - Feature not supported
 - Value outside of range
 - Error Information (Codes must be standardized)

Set maximum ramp rates for storage charging rate – signal to charge, discharge and maximum ramp rate request – the local device then determines exactly the actual ramp rate, based on local conditions and possible local pricing. This could be a pricing schedule. Should there be a time schedule where you want it charged by a certain time?

Also could be a combined PV/storage that responds to a pricing signal to provide a net output, regardless of clouds or sun position.

What is the condition of the grid, so make your own decision based on that condition. (PAP 3 & 4?)

Either requests with minimal feedback (autonomous) or direct commands with direct feedback (managed systems).

4.3 IEC 61850 Reporting Commands

4.3.1 IEC 61850 Models for PC5: Event/History Logging 61850 Models

Use the IEC 61850 EventLog capability (see IEC 61850-7-2) to send event logs on request.

Basic requirements for event logging:

- All logs contain date and timestamps accurate to 500 milliseconds (?)
- All logs contain unique description or event code to identify the event, including cause of event and other distinguishing characteristics (If event codes are used, they must be standardized)
- All errors or failures must be logged
- All startup and shutdown actions must be logged
- All control actions must be logged, whether triggered by external commands from the “Customer EMS”, or internal responses to external events (e.g. loss of external frequency, exceeding the temperature limit, etc.)
- All responses to control actions must be logged, whether they were successful or rejected (with explanation of cause of rejection)
- All limit violations must be logged, including returns within limits
- Specific examples:
 - Inverter Start Up time and date
 - Inverter Controlled Shut Down time and date
 - IEEE 1547 caused shut downs: time/date, duration (voltage sag, power outage, etc)
 - Utility commands for action time and date
 - Equipment failure
 - PV/Inverter failure, failure type time and date
 - Equipment Trip Out: overload due to excessive power, temperature limits exceeded, inadequate DC bus voltage: cause, time and date
 - Inability to fulfill dispatch schedule or peak demand request: cause, time and date

Use the IEC 61850 EventLog capability (see IEC 61850-7-2) to send event logs on request.

4.3.2 IEC 61850 Models for PC6: Status Reporting

Many functions require the status of the PV inverter either periodically, on significant change of a value, or upon request. In these cases, at least the following data will be reported in a DataSet:

- ZINV:
 - Current connect mode – Connected/disconnected
 - Inverter stand-by status – True: stand-by active
 - DC current level available for operation – True: sufficient current
 - Output power setpoint
 - Output reactive power setpoint
 - Power factor setpoint as angle (optional)
 - Frequency setpoint (optional)
- MMXU from IEC 61850-7-4:
 - Total Active Power (Total P): Value, High and Low Limits
 - Total Reactive Power (Total Q): Value, High and Low Limits
 - Average Power factor (Total PF), Value, High and Low Limits

- Phase to ground voltages (VL1ER, ...): Value, High and Low Limits
- ZBAT (if storage is included in PV system):
 - Amp-hour capacity rating
 - Minimum resting amp-hour capacity rating allowed
 - Nominal voltage of battery
 - Maximum battery discharge current
 - Maximum battery charge voltage
 - High battery voltage alarm level
 - Low battery voltage alarm level
 - External battery voltage
 - Rate of output battery voltage change
 - Internal battery voltage
 - Battery drain current
 - Internal battery current
 - Need to add:
 - State of charge (energy % of maximum charge level)
 - Reserve (Minimum energy charge level allowed, % of maximum charge level)
 - Available Energy (State of charge – Reserve)

4.4 IEC 61850 Periodic Commands

4.4.1 IEC 61850 Models for PC7: Time Synchronization

The PV inverter would use of Network Time Protocol (NTP) (RFC-1305) or Simple Network Time Protocol (SNTP) (RFC 1305) between the “customer EMS” and the PV inverter to set time.

4.5 IEC 61850 Decentralized Var Support Using IEC 61850

4.5.1 IEC 61850 Volt/Var Array (SubMode) Settings

For each PVx Mode, the utility/ESP may issue one or more Volt/Var Array Settings of specific volt/var paired arrays (up to a maximum number of Volt/Var Array Settings per Mode and maximum number of array entries per Volt/Var Array Setting, e.g. *max of 5 Groups per Mode, max of 8 array entries per Group*). The first entry in the voltage array is the lowest voltage value, with the following array values having increasing voltage levels. The var entries (% of Qmax) apply to the corresponding voltage entry.

The following 61850 setting commands will be used to set volt/var arrays:

1. **ZINV:** The ZINV logical node defines the characteristics of the inverter, which converts DC to AC. The DC may be the output of the generator or may be the intermediate energy form after a generator’s AC output has been rectified. (*defined in IEC 61850-7-420*).

- a. Identity of the mode (e.g. *PV1, PV2, PV3, PV4, etc.*) (*new*)
- b. Identity of the volt/var array being set (e.g. *Group 1, Group2, etc.*) (*new*)
- c. Number of elements in the array
- d. Array of voltage settings as specific voltage values (*new*)
- e. Corresponding array of var settings (% of Qmax) associated with the voltage settings (*new*)
- f. Nominal ramp rate for providing the requested vars (seconds)
- g. Default random time delay range in seconds before starting (e.g. *0 (=immediate), 30 seconds, 60 seconds, 300 seconds, etc.*)

4.5.2 IEC 61850 PV Mode Request for Non-Schedule-based Modes

The utility/ESP can issue a mode request to one or more PV inverters either at the same time as issuing the volt/var array settings or at a later time:

1. **DOPM:** This DER controller logical provides settings for the operating mode at the ECP. This LN can be used to set available operating modes as well as to set actual operating modes. More than one mode can be set simultaneously for certain logical combinations (*defined in IEC 61850-7-420*).
 - a. Mode of operation (e.g. *PV1, PV2, PV3, or PV4*) (*new*)
 - b. Identity of array of volt/var settings (e.g. *Group 1, Group2, etc.*) (*new*)
 - c. Nominal ramp rate for providing the requested vars (seconds)
 - d. Default random time delay range before starting (e.g. *0 (=immediate), 30 seconds, 60 seconds, 300 seconds, etc.*)
 - e. RemTmm = Timeout for reverting to default state

4.5.3 IEC 61850 PV Mode Response

The IEC 61850 response to a mode request (if permitted) will consist of:

1. **DOPM** (*defined in IEC 61850-7-420*):
 - a. Mode of operation – acknowledged

If the status of the PV inverter is desired, then the following will also be provided (*the same as Function #6 – Status Reporting*):

2. **ZINV** (*defined in IEC 61850-7-420*):
 - a. Current connect mode – Connected/disconnected
 - b. Inverter stand-by status – True: stand-by active
 - c. DC current level available for operation – True: sufficient current
 - d. Output power setpoint
 - e. Output reactive power setpoint
 - f. Power factor setpoint as angle (optional)
 - g. Frequency setpoint (optional)
2. **MMXU** (*defined in IEC 61850-7-4*):

- a. Active Power (Total P): Value, High and Low Limits
 - b. Reactive Power (Total Q): Value, High and Low Limits
 - c. Average Power factor (Total PF), Value, High and Low Limits
 - d. Phase to ground voltages (VL1ER, ...): Value, High and Low Limits
3. **ZBAT** (if storage is included in PV system) (*defined in IEC 61850-7-420*):
- a. Amp-hour capacity rating
 - b. Minimum resting amp-hour capacity rating allowed
 - c. Nominal voltage of battery
 - d. Maximum battery discharge current
 - e. Maximum battery charge voltage
 - f. High battery voltage alarm level
 - g. Low battery voltage alarm level
 - h. External battery voltage
 - i. Rate of output battery voltage change
 - j. Internal battery voltage
 - k. Battery drain current
 - l. Internal battery current
 - m. State of charge (energy % of maximum charge level)
 - n. Reserve (Minimum energy charge level allowed, % of maximum charge level)
 - o. Available Energy (State of charge – Reserve)

4.5.4 IEC 61850 Scheduling PV Modes

The “scheduled” IEC 61850 command from the utility/ESP is optional, but is defined as follows:

1. **Issue Groups of volt/var arrays for each of the different Modes: DRCC:** The DER supervisory control logical node defines the control actions for one DER unit or aggregations of one type of DER device with a single controller (*defined in IEC 61850-7-420*).
 - a. Identity of the volt/var array being set (*e.g. Group 1, Group 2, etc.*) (*new*)
 - b. Number of elements in the array
 - c. Array of voltage settings as specific voltage values (*new*)
 - d. Corresponding array of var settings (% of Qmax) associated with the voltage settings (*new*)
 - e. Nominal ramp rate for providing the requested vars (seconds)
 - f. Default random time delay range before starting (*e.g. 0 (=immediate), 30 seconds, 60 seconds, 300 seconds, etc.*)
2. **Issue Direct Control Mode: DOPM:** This DER controller logical provides settings for the operating mode at the ECP. This LN can be used to set available operating modes as well as to set actual operating modes. More than one mode can be set simultaneously for certain logical combinations (*defined in IEC 61850-7-420*).
 - a. Mode of operation (*PV5 direct control*) (*new*)
 - b. Identity of array of volt/var settings (*e.g. Group 1, Group 2, etc.*) (*new*)

- c. Nominal ramp rate for providing the requested vars (seconds)
 - d. Default random time delay range before starting (*e.g. 0 (=immediate), 30 seconds, 60 seconds, 300 seconds, etc.*)
 - e. RemTmm = Timeout for reverting to default state after schedule has ended and is not repeated
3. **Issue Time Schedule using relative time DSCH Schedule:** The DSCH logical node defines a DER energy and/or ancillary services schedule. Multiple schedules can be defined, using DSCC LN to control which ones are active. Each DSCH is associated with one or more ECPs.
- a. Category of schedule: time-based
 - b. Schedule for which Group (*e.g. Group 1, Group 2, etc.*)
 - c. Associated time to start relative to the beginning of the schedule (*i.e. seconds past midnight*)
4. **Issue Temperature Schedule using temperature DSCH Schedule:** The DSCH logical node defines a DER energy and/or ancillary services schedule. Multiple schedules can be defined, using DSCC LN to control which ones are active. Each DSCH is associated with one or more ECPs.
- a. Category of schedule: temperature-based
 - b. Schedule for which Group (*e.g. Group 1, Group 2, etc.*)
 - c. Associated temperature and deadband around temperature for using a Mode and a Group of volt/var settings.
5. **Start relative schedule DSCC:** The DSCC logical node controls the use of DER energy and ancillary services schedules. Each DSCC is associated with one or more ECPs. Time activated control shall be used to establish the start time for schedules using relative time and if the start time is in the future.
- a. Activate specific energy schedule, using TimeActivatedOperate to establish start time for schedules using relative time and if start time is in the future. ctrVal: 0 = deactivate, 1 = activate

4.5.5 IEC 61850 Scheduling PV/Storage

TBD

5. Future Activities

Some future activities are touched on in the following subsections, primarily to acknowledge that these types of issues exist and need to be addressed in on-going efforts and projects.

5.1 Abstract Object Models and Communication Protocols

This specification addresses the mapping of the different PV system interactions to IEC 61850 object models. *The mapping of these abstract IEC 61850 object models to actual communication protocols is out of scope for this document.*

Different protocols could be involved in different situations, partly depending upon locations (customer site versus utility-owned site), configurations, utility policies, and vendor capabilities.

However, a few communication protocol issues are pertinent, since interactions between utilities and DER equipment at customer sites have not been implemented widely and certainly not with standards. For instance:

- There is no single communication protocol that is currently seen as being able to cover all interactions described in this document.
- At the physical layer, both wired and wireless solutions are expected to be used, with many options within these, including power line carrier, broadband power line carrier, Cat 5 cabling, WiFi, ZigBee, WiMax, and many off-shoots of these.
- At the transport layer, it is expected that IP (Internet Protocol) will provide device addressing. TCP will probably be used in some but not all implementations.
- At the application layer, some candidates exist, but none can (yet) fulfill all requirements:
 - DNP3 is not capable of truly handling 61850 object models – these models must be “dumbed down” in order to be mapped to the DNP3 simple models.
 - DNP3 is not currently considered a candidate for intra-customer site communications.
 - The Smart Energy Profile (SEP) is not currently considered a candidate for utility-to-customer communications. Therefore, there may need to be a “protocol conversion” of the broadcast message from the utility at the “Energy Services Interface/HAN Gateway” in the customer site.
 - SEP is still under development and may present some challenges for tightly-coupled interactions.
 - Web services may be used in some instances, but present some challenges for tightly-coupled interactions.
 - OPC/UA is another possible candidate, but very little effort has yet been undertaken for the mapping of IEC 61850.

Although outside the scope of this particular document, the PV/Storage communication project intends to continue with some of these protocol mappings – particularly considering DNP3 and SEP.

5.2 Possible Additional Utility-DER Interactions

This specification is only the beginning of the many types of interactions between utilities and Distributed Energy Resources (DER), including:

- Utility-controlled generation and storage explicitly dedicated to utility power system management requirements
- DER generation and storage used primarily to meet customer needs, but available to the utility within specified limits for specified purposes, usually also involving pricing signals or tariff contracts.

Some of the other interactions, particularly those involving inverters, converters, and combined generation/storage, can be similar to the PV inverter interactions, although certain technology-specific settings and status information will be different.

The following are notes on issues and possible additional interactions.

5.2.1 *Watt / Frequency or Watt/Voltage Modes*

In the same way that the volt/var modes described above allow PV inverters to intelligently manage their var generation, modes could be defined that would allow them to manage their watt generation as a function of locally observed line frequency or locally observed line voltage. Systems that include storage may be able to dynamically both sink and source watts – essentially providing a regulation effect. In some cases, the dynamic ability to source or sink watts may significantly exceed the steady-state ratings of the device.

5.2.2 *Advanced Schedules*

The scheduling mechanisms described above only allow for a linear or daily repeating schedule. In the future, more extensive mechanisms may allow for weekly schedules, with unique Saturday and Sunday schedules, seasons, daylight savings time, and holidays.

5.2.3 *Voltage Sag Ride-Through*

Under certain circumstances, it may be desirable for both PV-only and PV/Storage systems to continue producing energy for some period (configurable) into a voltage sag.

5.2.4 *Separate Watt and Var Management*

Comments noted from a project participant:

I believe that separate VAR and Watts management are really the only practical solution. I like the modes we developed for the various options for VAR management, and I believe that we will be doing the same thing for watts. Really, the approach for VAR management we have developed applies to any converter, not just a PV inverter. When we start looking at watt management, there will be a number of different services that we can provide: regulation, spinning reserve, peak

shifting, operating reserve, etc. I agree it would be too detailed to get into these specific services now. The only way the different services differ is in the number of MW, allowable response time (latency), response duration, and how often the services are called for. As long as we cover these parameters, that is all we need to do.

5.2.5 Grid-Connected Converter Interactions

Comments noted from a project participant:

Rather than calling it an inverter specification, it should be a converter specification because storage includes power flows both in and out. An overall outline for these and future functions for any converter might be as follows:

1. Section One: Brief overview of some of the use cases for grid connected converters which give rise to this need.
 - a. Volt VAR Control
 - b. Watt/Frequency control
 - c. Energy Arbitrage
 - d. Renewables integration
2. Section Two: Low level functions of Converters
 - a. Sense Voltage and Frequency
 - b. Sense time rate of change of voltage and frequency
 - c. Determine actual +/- real/reactive power output
 - d. Determine maximum available +/- real/reactive power available
 - e. Change to any given combination of available +/- real/reactive power
 - f. Report nameplate information
 - g. Report current state of V, f, P, Q, P/Q available
3. Section Three: High level functions of converters or systems that control converters
 - a. Implement P/f schedule, i.e. P(f)
 - b. Implement Q/V schedule i.e. Q(V)
 - c. Implement +/- P activity as function of price information
 - d. Provide maximum available +/- P/Q on demand subject to limits (available P/Q, V/f limits, machine limits)
4. Section Four: Even higher level functions of converters or systems that control converters
 - a. Modes
 - b. Schedules

- c. Biasing schedules as a function of time, temperature, or other parameters
 - d. Changing response time of schedules such that the converter P(f) and/or Q(V) responds to transients or only steady state
5. Section Five: IEC 61850 Object Models and Capability definitions to facilitate Sections Two through Four
 6. Section Six: Some examples of how Section Five definitions enable Section One use cases

5.2.6 Harmonic Cancellation

Needs to be addressed first in IEEE 1547.8

6. Members of PV Inverter Data Identification Focus Group (DIFG)

The following people actively participated in the development of this Specification.

Name	Organization		
Sean O'Connor	Apollo Solar	Greg Linder	SixNet
Michael Sheehan	Consultant	Bob Schmitt	SMA-America
Hawk Asgeirsson	DTE	Lars Johnson	SunPower Corp.
Chris Eich	Enphase Energy	Vic Shao	The Prosser Group
Brian Seal	EPRI	David Bateman	TimberRock Energy Solutions
Dan Lepinski	Exeltech	Brent Hollenbeck	TimberRock Energy Solutions
Rich Barone	Infotility	Glenn Skutt	VPT Energy Systems
Dave Cohen	Infotility	Frances Cleveland	Xanthus Consulting
Diana Buttz	Itron	Trevor Monk	Xantrex
Fouad Dagher	National Grid		
Justin	National Grid		
Allen Hefner	NIST		
John Kueck	Oak Ridge National Lab		
Ronald Hamaoui	Petra Solar		
Swarnab Banerjee	Princeton Power		
Jim Perkinson	Satcon		
Russ Neal	SCE		
Chris Clarke	SCE		
John Altstadt	Schneider		
Christy Herig	SEPA		
Dan Pehrson	Silent Power		