

RENEWABLE MARKET ADJUSTING TARIFF POWER PURCHASE AGREEMENT

[This contract has been approved by the California Public Utilities Commission in Decision 13-05-034. Modification of the terms and conditions of this contract will result in the need to obtain additional Commission approval of the contract.]

[The contract approved by Decision 13-05-034 includes terms and conditions that “may not be modified” pursuant to prior Commission decisions, including Decision 07-11-025, Decision 08-08-028 and Decision 10-03-021, as modified by Decision 11-01-025, and these terms and conditions are shown in shaded text.]

**RENEWABLE MARKET ADJUSTING TARIFF
POWER PURCHASE AGREEMENT
BETWEEN
PACIFIC GAS AND ELECTRIC COMPANY AND
PUTAH CREEK SOLAR FARMS LLC**

RENEWABLE MARKET ADJUSTING TARIFF POWER PURCHASE AGREEMENT

TABLE OF CONTENT

<u>1.</u>	<u>DOCUMENTS INCLUDED</u>	3
<u>2.</u>	<u>SELLER'S FACILITY AND COMMERCIAL OPERATION DATE</u>	4
<u>3.</u>	<u>CONTRACT CAPACITY AND QUANTITY; TERM; CONTRACT PRICE; BILLING</u>	7
<u>4.</u>	<u>GREEN ATTRIBUTES; RESOURCE ADEQUACY BENEFITS; EIRP REQUIREMENTS; ERR REQUIREMENTS; QUALIFYING FACILITY STATUS</u>	13
<u>5.</u>	<u>REPRESENTATION AND WARRANTIES; COVENANTS</u>	18
<u>6.</u>	<u>GENERAL CONDITIONS</u>	21
<u>7.</u>	<u>INDEMNITY</u>	28
<u>8.</u>	<u>LIMITATION OF DAMAGES</u>	29
<u>9.</u>	<u>NOTICES</u>	29
<u>10.</u>	<u>INSURANCE</u>	29
<u>11.</u>	<u>FORCE MAJEURE</u>	32
<u>12.</u>	<u>GUARANTEED ENERGY PRODUCTION</u>	34
<u>13.</u>	<u>CREDIT AND COLLATERAL REQUIREMENTS</u>	35
<u>14.</u>	<u>EVENTS OF DEFAULT AND TERMINATION</u>	38
<u>15.</u>	<u>SCHEDULING COORDINATOR; FORECASTING PENALTIES; CAISO CHARGES; GOVERNMENTAL CHARGES</u>	43
<u>16.</u>	<u>RELEASE OF INFORMATION AND RECORDING CONVERSATION</u>	44
<u>17.</u>	<u>ASSIGNMENT</u>	45
<u>18.</u>	<u>GOVERNING LAW</u>	45
<u>19.</u>	<u>DISPUTE RESOLUTION</u>	46
<u>20.</u>	<u>MISCELLANEOUS</u>	48

APPENDIXES

<u>APPENDIX A - DEFINITIONS</u>	51
<u>APPENDIX B – COMMERCIAL OPERATION DATE CONFIRMATION LETTER</u>	68
<u>APPENDIX C – TIME OF DELIVERY PERIODS AND PAYMENT ALLOCATION FACTORS</u>	69
<u>APPENDIX D – FORECASTING AND OUTAGE NOTIFICATION REQUIREMENTS</u>	71
<u>APPENDIX E – DESCRIPTION OF THE FACILITY</u>	76
<u>APPENDIX F – TELEMETRY REQUIREMENTS</u>	77
<u>APPENDIX G – GUARANTEED ENERGY PRODUCTION DAMAGES</u>	80
<u>APPENDIX H – FORM OF LETTER OF CREDIT</u>	81
<u>APPENDIX I - SELLER'S MILESTONE SCHEDULE</u>	85
<u>APPENDIX J – NOTICES LIST</u>	86
<u>APPENDIX K – FORM OF GENERAL CONSENT TO ASSIGNMENT</u>	88
<u>APPENDIX L – FORM OF FINANCING CONSENT TO ASSIGNMENT</u>	93
<u>APPENDIX M - PROCEDURE FOR DEMONSTRATION OF CONTRACT CAPACITY</u>	100
<u>APPENDIX N-1 - QF EFFICIENCY MONITORING PROGRAM – COGENERATION DATA REPORTING FORM</u>	102
<u>APPENDIX N-2 - FUEL USE STANDARDS – SMALL POWER PRODUCER DATA REPORTING FORM</u>	104

RENEWABLE MARKET ADJUSTING TARIFF POWER PURCHASE AGREEMENT

Pacific Gas and Electric Company, a California corporation (“Buyer” or “PG&E”), and Putah Creek Solar Farms LLC (“Seller”), a California limited liability company

[Seller’s form of business entity and state of organization], hereby enter into this Power Purchase Agreement (“Agreement”) made and effective as of the Execution Date. Seller and Buyer are sometimes referred to in this Agreement jointly as “Parties” or individually as “Party.” In consideration of the mutual promises and obligations stated in this Agreement and its appendices, the Parties agree as follows:

1. DOCUMENTS INCLUDED

This Agreement includes the following appendices, which are specifically incorporated herein and made a part of this Agreement:

- Appendix A Definitions
- Appendix B Commercial Operation Date Confirmation Letter
- Appendix C Time of Delivery Periods and Payment Allocation Factors
- Appendix D Forecasting and Outage Notification Requirements
- Appendix E Description of the Facility
- Appendix F Telemetry Requirements
- Appendix G Guaranteed Energy Production Damages
- Appendix H Form of Letter of Credit
- Appendix I Seller’s Milestone Schedule
- Appendix J Notices List
- Appendix K Form of General Consent to Assignment
- Appendix L Form of Financing Consent to Assignment
- Appendix M Procedure for Demonstration of Contract Capacity
- Appendix N-1 QF Efficiency Monitoring Program – Cogeneration Data Reporting Form
- Appendix N-2 Fuel Use Standards – Small Power Producer Data Reporting Form

RENEWABLE MARKET ADJUSTING TARIFF POWER PURCHASE AGREEMENT

2. SELLER'S FACILITY AND COMMERCIAL OPERATION DATE

This Agreement governs Buyer's purchase of the Product from the electrical generating facility (hereinafter referred to as the "Facility" or "Project") as described in this Section.

2.1. Facility Location. The Facility is physically located at:

Corner of Highway 128 and County Road 87D

Winters, California 95694

2.2. Facility Name. The Facility is named Putah Creek Solar Farms.

2.3. Type of Facility.

2.3.1. The Facility is a(n) (check one):

Baseload Facility

As-Available Facility

2.3.2. The Facility's renewable resource is Solar - Photovoltaic [PV]. [e.g., biogas, hydro, etc.]

2.3.3. The Facility is a (check all applicable):

"small power production facility," as described in 18 CFR §§292.203(a), 292.203(c) and 292.204

"topping-cycle cogeneration facility," as defined in 18 CFR §292.202(d)

"bottoming-cycle cogeneration facility," as defined in 18 CFR §292.202(e)

2.4. Interconnection Queue Position. The Project's interconnection queue position is 0141-WD. The Project's interconnection queue position may only be used for the sole benefit of the Project.

2.5. Interconnection Point. The Facility is connected to PG&E electric system at Putah Creek Circuit #1102 [include description of physical interconnection point] at a service voltage of 12 kV.



RENEWABLE MARKET ADJUSTING TARIFF POWER PURCHASE AGREEMENT

- 2.6. **Delivery Point.** The Delivery Point is at the point of interconnection with the CAISO Grid, Putah Creek Substation [insert name or location].
- 2.7. **Facility Description.** A description of the Facility, including a summary of its significant components, a drawing showing the general arrangements of the Facility, and a single line diagram illustrating the interconnection of the Facility and loads with Buyer's electric distribution system, is attached and incorporated herein as Appendix E.
- 2.8. **Expected Commercial Operation Date; Guaranteed Commercial Operation Date.**
- 2.8.1. If not already capable of delivering Product on the Execution Date, the Facility's expected Commercial Operation Date is 2/1/2015, which may, subject to the terms of the Agreement, be modified by Seller from time to time after the Execution Date. Seller shall provide Notice to Buyer of the latest expected Commercial Operation Date of the Facility no later than sixty (60) days before such date.
- 2.8.2. Seller shall have demonstrated Commercial Operation by the "Guaranteed Commercial Operation Date," which date shall be no later than the date that is twenty-four (24) months (720 days) after the Execution Date; provided that, subject to Section 2.8.4, the Guaranteed Commercial Operation Date may be extended for the following reasons ("Permitted Extensions"):
- 2.8.2.1. Subject to Section 2.8.5, if Seller has taken all commercially reasonable actions (including but not limited to Seller's timely filing of required documents and payment of all applicable fees) to obtain permits necessary for the construction and operation of the Project, but is unable to obtain such permits due to delays beyond Seller's reasonable control ("Permitting Delay"), then the Guaranteed Commercial Operation Date shall be extended six (6) months;
- 2.8.2.2. Subject to Section 2.8.5, if Seller has taken all commercially reasonable actions (including but not limited to Seller's timely filing of required documents and payment of all applicable fees, and completion of all Electric System Upgrades needed, if any) to have the Project physically interconnected to the Transmission/Distribution Owner's distribution system, but fails to secure any necessary commitments from CAISO or the Transmission/Distribution Owner for such interconnection and upgrades due to delays beyond Seller's reasonable control

RENEWABLE MARKET ADJUSTING TARIFF POWER PURCHASE AGREEMENT

(“Transmission Delay”), then the Guaranteed Commercial Operation Date shall be extended six (6) months;

2.8.2.3. In the event of Force Majeure (“Force Majeure Delay”) without regard to Transmission Delay or Permitting Delay, the Guaranteed Commercial Operation Date shall be extended on a day-to-day basis for a cumulative period of not more than six (6) months; provided that Seller complies with Section 11; or

2.8.2.4. If Seller pays to Buyer damages in an amount equal to two percent (2%) of the Collateral Requirement per day for each day (or portion thereof) the Guaranteed Commercial Operation Date is extended (“Daily Delay Liquidated Damages”), then the Guaranteed Commercial Operation Date shall be extended on a day-to-day basis corresponding to the number of days for which Seller has paid Daily Delay Liquidated Damages for a cumulative period of not more than six (6) months. Daily Delay Liquidated Damages payments applicable to days included in any Guaranteed Commercial Operation Date extension are nonrefundable and are in addition to, and not a part of, the Collateral Requirement; provided that Seller will be entitled to a refund (without interest) of any estimated Daily Delay Liquidated Damages payments paid by Seller to Buyer which exceed the amount required to cover the number of days by which the Guaranteed Commercial Operation Date was actually extended.

2.8.3. All Permitted Extensions taken shall be concurrent, rather than cumulative, during any overlapping days.

2.8.4. Notwithstanding anything in this Agreement, the Guaranteed Commercial Operation Date shall be no later than the date that is thirty (30) months after the Execution Date.

2.8.5. Upon request from Buyer, Seller shall provide documentation demonstrating to Buyer’s reasonable satisfaction that the Permitted Extensions described in Section 2.8.2.1 or 2.8.2.2 (as applicable), did not result from Seller’s action or failure to take action as described in Section 2.8.2.1 or 2.8.2.2 (as applicable)

2.9. Notice of Permitted Extension.

2.9.1. In order to request a Permitting Delay or Transmission Delay (individually and collectively, “Delay”), Seller shall provide Buyer with Notice of the requested Delay by the later of (a) the date that is twenty-two (22) months (660 days) after the Execution Date and (b) within three (3) Business Days of the date that Seller becomes aware

RENEWABLE MARKET ADJUSTING TARIFF POWER PURCHASE AGREEMENT

of, or reasonably should have become aware of, the circumstances giving rise for the applicable Delay, which Notice must clearly identify the Delay being requested and include information necessary for Buyer to verify the qualification of the Delay. Buyer shall use reasonable discretion to grant or deny the requested extension, and shall provide Seller Notice of its decision within ten (10) Business Days of Notice from Seller.

2.9.2. In the case of a Force Majeure Delay, Seller shall provide Notice as specified in Section 11.2.

2.9.3. In the case of an extension of the Guaranteed Commercial Operation Date by the payment of Daily Delay Liquidated Damages, Seller must, at the earliest possible time, but no later than five (5) Business Days before the commencement of the proposed Guaranteed Commercial Operation Date extension, provide Buyer with Notice of its election to extend the Guaranteed Commercial Operation Date along with Seller's estimate of the duration of the extension and its payment of Daily Delay Liquidated Damages for the full estimated Guaranteed Commercial Operation Date extension period.

2.9.4. Notwithstanding anything to the contrary herein, Seller shall provide Notice to Buyer of the latest expected Commercial Operation Date of the Facility no later than sixty (60) days before the Commercial Operation Date.

3. CONTRACT CAPACITY AND QUANTITY; TERM; CONTRACT PRICE; BILLING

3.1. Contract Capacity. The Contract Capacity is 2000 kW. The Contract Capacity shall not exceed 3,000 kW. The Contract Capacity is subject to adjustment based on the Demonstrated Contract Capacity and the definition of "Contract Capacity."

3.2. Contract Quantity. The "Contract Quantity" during each Contract Year is the amount set forth in the applicable Contract Year in the "Delivery Term Contract Quantity Schedule," set forth below, which amount is net of Station Use, and, for excess sale arrangements, Site Host Load. Seller shall have the option to update the Delivery Term Contract Quantity Schedule one (1) time to the extent such a change is necessary based upon any adjustment to the Contract Capacity based on the Demonstrated Contract Capacity and the definition of "Contract Capacity," within ten (10) Business Days of Buyer's Notice of such adjustment to the Contract Capacity or the date of the Engineer Report, as applicable, which adjusted amounts shall thereafter be the applicable "Contract Quantity."

RENEWABLE MARKET ADJUSTING TARIFF POWER PURCHASE AGREEMENT

Delivery Term Contract Quantity Schedule	
Contract Year	Contract Quantity (kWh/Yr)
1	4,639,528
2	4,604,732
3	4,570,196
4	4,535,920
5	4,501,901
6	4,468,136
7	4,434,625
8	4,401,366
9	4,368,355
10	4,335,593
11	4,303,076
12	4,270,803
13	4,238,772
14	4,206,981
15	4,175,429
16	4,144,113
17	4,113,032
18	4,082,184
19	4,051,568
20	4,021,181

3.3. Transaction. During the Delivery Term, Seller shall sell and deliver, or cause to be delivered, and Buyer shall purchase, the Product from the Facility at the Delivery Point, pursuant to Seller’s election of a(n) (check one):

- full buy/sell; or
- excess sale arrangement.

In no event shall Seller have the right to procure the Product from sources other than the Facility for sale or delivery to Buyer under this Agreement or substitute such Product. Buyer shall have no obligation to receive or purchase the Product from Seller prior to the Commercial Operation Date or after the end of the Delivery Term.

3.4. Term of Agreement; Survival of Rights and Obligations.

3.4.1. The term shall commence upon the Execution Date of this Agreement and shall remain in effect until the conclusion of the Delivery Term unless terminated sooner pursuant to Sections 11.4 or 14 of this Agreement (the “Term”).



RENEWABLE MARKET ADJUSTING TARIFF POWER PURCHASE AGREEMENT

3.4.2. Notwithstanding anything to the contrary in this Agreement, the rights and obligations that are intended to survive a termination of this Agreement are all of those rights and obligations that this Agreement expressly provides survive any such termination and those that arise from Seller's or Buyer's covenants, agreements, representations, and warranties applicable to, or to be performed, at or during any time before or as a result of the termination of this Agreement, including: (a) all obligations to pay in full amounts due, including under Sections 3.6, 12, 13.3, 14 and 15, (b) all obligations to post, maintain, return and release the Collateral Requirement under Section 13, (c) Seller's obligations under Sections 4.1, 4.2, 4.3 and 6.11, (d) all rights and obligations under Sections 6.4, 7, 10.2.7, and 14.8.4, and any other indemnity rights, (e) the limitations on liability set forth in Section 8, (f) all rights and obligations under Section 16, (g) all rights and obligations under Section 14.8, (h) the governing law set forth in Section 18, and (i) the dispute resolution provisions set forth in Section 19.

3.5. Delivery Term. The Seller shall deliver the Product from the Facility to Buyer for a period of (check one) ten (10), fifteen (15), or twenty (20) Contract Years ("Delivery Term"), which shall commence on the Commercial Operation Date under this Agreement and continue until the end of the last Contract Year unless terminated by the terms of this Agreement. The Commercial Operation Date shall occur only when all of the following conditions have been satisfied:

3.5.1. the Facility's status as an Eligible Renewable Energy Resource is demonstrated by Seller's receipt of pre-certification from the CEC;

3.5.2. if required pursuant to Section 4.8, the Facility's status as a Qualifying Facility is demonstrated by Seller's receipt of a docket number assigned to Seller's filing of FERC Form 556;

3.5.3. as evidence of the Commercial Operation Date, the Parties shall execute and exchange the "Commercial Operation Date Confirmation Letter" attached as Appendix B;

3.5.4. Seller has provided to Buyer the Collateral Requirement specified in Section 13;

3.5.5. Seller has satisfied all of the CAISO agreement, interconnection agreement, and metering requirements in Sections 6.1 and 6.2 and has enabled Buyer to schedule the Facility with the CAISO;

3.5.6. Seller has furnished to Buyer all insurance documents required under Section 10;



RENEWABLE MARKET ADJUSTING TARIFF POWER PURCHASE AGREEMENT

- 3.5.7. Seller has delivered to Buyer the first report required under Section 6.12.4;
- 3.5.8. Seller has satisfied all of the telemetry requirements required to be satisfied by the Commercial Operation Date under Section 6.10 and Appendix F;
- 3.5.9. the Demonstrated Contract Capacity has been determined in accordance with Appendix M;
- 3.5.10. Seller has provided sixty (60) days Notice prior to the Commercial Operation Date as required under Section 2.8.1;
- 3.5.11. Seller has delivered to Buyer the report required under Section 6.16, if any; and
- 3.5.12. Seller has delivered to Buyer any currently operative filings at FERC, including any rulings, orders or other pleadings or papers filed by FERC, concerning the qualification of the Facility as a Qualifying Facility.
- 3.6. Contract Price.
- 3.6.1. The price for Delivered Energy (the "Contract Price") is point zero eight nine two three *[Dollar amount as text]* dollars (\$ 0.08923 *[Number]*) per kWh. *[Contract Price to be determined by Re-MAT pricing methodology.]*
- 3.6.2. In no event shall Buyer be obligated to receive or pay for, in any hour, any Delivered Energy that exceeds one hundred and ten percent (110%) of Contract Capacity, and the Contract Price for such Delivered Energy in excess of such one hundred and ten percent (110%) of Contract Capacity shall be adjusted to be Zero dollars (\$0) per kWh.
- 3.6.3. In any Contract Year, if the amount of Delivered Energy exceeds one hundred twenty percent (120%) of the annual Contract Quantity amount, the Contract Price for such Delivered Energy in excess of such one hundred twenty percent (120%) shall be adjusted to be seventy-five percent (75%) of the applicable Contract Price.
- 3.7. Billing.
- 3.7.1. The amount of Product purchased by Buyer from Seller under this Agreement at the Delivery Point is determined by the meter specified in Section 6.2.1 or Check Meter, as applicable. Throughout the Delivery Term and subject to and in accordance with the terms of this

RENEWABLE MARKET ADJUSTING TARIFF POWER PURCHASE AGREEMENT

Agreement, Buyer shall pay the Contract Price to Seller for the Product; provided that Buyer has no obligation to purchase from Seller any Product that is not or cannot be delivered to the Delivery Point as a result of any circumstance, including: (a) an outage of the Facility; (b) a Force Majeure under Section 11; or (c) a reduction or curtailment of deliveries in accordance with Sections 6.8.1(a) or (b). Buyer will not be obligated to pay Seller for any Product that Seller delivers in violation of Section 6.8, including any Product Seller delivers in excess of the amount specified in any Curtailment Order.

3.7.2. For the purpose of calculating monthly payments under this Agreement, the amount recorded by the meter specified in Section 6.2.1 or Check Meter, as applicable, will be time-differentiated according to the time period and season of the receipt of the Product by Buyer from Seller, as set forth in Appendix C, and the pricing will be weighted by the Payment Allocation Factors.

3.7.3. The monthly payment will equal the sum of (a) the sum of the monthly TOD Period payments for all TOD Periods in the month and (b) the Curtailed Product Payment for the month. Each monthly TOD Period payment will be calculated pursuant to the following formula, where “n” is the TOD Period being calculated:

$$\text{TOD PERIOD}_n \text{ PAYMENT} = A \times B \times (C - D)$$

Where:

- A = Contract Price, in \$/kWh.
- B = The Payment Allocation Factor for the TOD Period being calculated.
- C = The sum of Energy recorded by the meter specified in Section 6.2.1 or Check Meter, as applicable, in all hours for the TOD Period being calculated, in kWh.
- D = Any Energy produced by the Facility for which Buyer is not obligated to pay Seller as set forth in Section 3.7.1.

3.7.4. On or before the last Business Day of the month immediately following each calendar month, Seller shall determine the amount of Product received by Buyer pursuant to this Agreement for each monthly period and issue an invoice showing the calculation of the payment. Seller shall also provide to Buyer: (a) records of metered data, including CAISO metering and transaction data sufficient to document and verify the generation of Product by the Facility for any CAISO settlement time interval during the preceding months; (b)



RENEWABLE MARKET ADJUSTING TARIFF POWER PURCHASE AGREEMENT

access to any records, including invoices or settlement data from the CAISO; and (c) an invoice, in the format specified by Buyer.

- 3.7.5. Buyer shall make payment of each invoice, adjusted by any amounts owed by or to Seller under this Agreement, on or before the later of the last Business Day of the month in which Buyer receives an invoice from Seller, or the tenth (10th) Business Day after receipt of the invoice; provided that Buyer shall have the right, but is not obligated, to apply any amounts due to Buyer from Seller for any charges incurred under this Agreement, for past due bills for electric service or for Buyer services, towards any amount owed to Seller under this Agreement. In the event Buyer applies any amounts due to Buyer from Seller towards an invoice issued by Seller, Buyer shall provide an explanation of the amounts Buyer has applied towards Seller's invoice.
- 3.7.6. In the event an invoice or portion thereof or any other claim or adjustment arising hereunder, is disputed, payment of the undisputed portion of the invoice shall be required to be made when due, with Notice of the objection given to the other Party. Any invoice dispute or invoice adjustment shall be in writing and shall state the basis for the dispute or adjustment. Payment of the disputed amount shall not be required until the dispute is resolved. In the event adjustments to payments are required as a result of inaccurate meter(s), Buyer shall determine the correct amount of Product received under this Agreement during any period of inaccuracy and recompute the amount due from Buyer to Seller for the Product delivered during the period of inaccuracy. The Parties agree to use good faith efforts to resolve the dispute or identify the adjustment as soon as possible. Upon resolution of the dispute or calculation of the adjustment, any required payment shall be made within thirty (30) days of such resolution along with simple interest accrued at the Interest Rate from and including the due date, but excluding the date paid. Inadvertent overpayments shall be returned upon request or deducted by the Party receiving such overpayment from subsequent payments, with simple interest accrued at the Interest Rate from and including the date of such overpayment, but excluding the date repaid or deducted by the Party receiving such overpayment. Any dispute with respect to an invoice is waived unless the other Party is notified in accordance with this Section 3.7.6 within twelve (12) months after the invoice is rendered or any specific adjustment to the invoice is made [,except for invoice disputes under Section 4.3 which are waived unless the other Party is notified in accordance with this Section 3.7.6 within twenty-four (24) months after the invoice is rendered or any specific adjustment to the invoice is made] [bracketed provision for Facilities (1) 500 kW or greater and (2) eligible for a CAISO revenue meter.] If



RENEWABLE MARKET ADJUSTING TARIFF POWER PURCHASE AGREEMENT

an invoice is not rendered by Seller within twelve (12) months after the close of the month during which performance occurred, the right to payment for such performance is waived.

- 3.7.7. Notwithstanding anything to the contrary in Section 3.7.5, Buyer may issue an invoice to Seller for any amount due under this Agreement. Unless explicitly stated otherwise, payment of such invoice shall be made within thirty (30) days of receipt of such invoice.
- 3.7.8. Unless otherwise agreed to in writing by the Parties, any payment due under this Agreement will be satisfied by issuance of a check, via Automated Clearing House transfer or via wire transfer. Notwithstanding anything to the contrary set forth in this Agreement, neither Party is obligated to make payment on any invoice until the cumulative amount due exceeds fifty dollars (\$50.00), except that both Parties shall pay all amounts due pursuant to this Agreement at least once per calendar year no later than thirty (30) days after the end of the calendar year.
- 3.7.9. All interest paid or payable under this Agreement shall be computed as simple interest using the Interest Rate and, unless specified otherwise in this Agreement, shall be paid concurrently with the payment or refund of the underlying amount on which such interest is payable.

3.8. Title and Risk of Loss. Title to and risk of loss related to the Product from the Facility shall transfer from Seller to Buyer from the Delivery Point. Seller warrants that it will deliver to Buyer the Product from the Facility free and clear of all liens, security interests, claims and encumbrances or any interest therein or thereto by any person arising prior to the Delivery Point.

4. **GREEN ATTRIBUTES; RESOURCE ADEQUACY BENEFITS; EIRP REQUIREMENTS; ERR REQUIREMENTS; QUALIFYING FACILITY STATUS**

- 4.1. Green Attributes. Seller hereby provides and conveys all Green Attributes associated with all electricity generation from the Project to Buyer as part of the Product being delivered. Seller represents and warrants that Seller holds the rights to all Green Attributes from the Project, and Seller agrees to convey and hereby conveys all such Green Attributes to Buyer as included in the delivery of the Product from the Project. [Standard term and condition that “may not be modified” pursuant to prior Commission decisions, including Decision 07-11-025, Decision 08-08-028, and Decision 10-03-021, as modified by Decision 11-01-025]
- 4.2. Conveyance of Product. Throughout the Delivery Term, Seller shall provide and convey the Product to Buyer in accordance with the terms of this Agreement, and Buyer shall have the exclusive right to the Product. Seller



RENEWABLE MARKET ADJUSTING TARIFF POWER PURCHASE AGREEMENT

shall, at its own cost, take all actions and execute all documents or instruments that are reasonable and necessary to effectuate the use of the Green Attributes, Resource Adequacy Benefits, if any, and Capacity Attributes, if any, for Buyer's benefit throughout the Delivery Term.

- 4.3. WREGIS. [*WREGIS Requirements for Facilities (1)500 kW or greater; and (2) eligible for a CAISO revenue meter*] [Seller shall, at its sole expense take all actions and execute all documents or instruments necessary to ensure that all WREGIS Certificates associated with all Renewable Energy Credits corresponding to all Energy produced by the Facility are issued and tracked for purposes of satisfying the requirements of the California Renewables Portfolio Standard and transferred in a timely manner to Buyer for Buyer's sole benefit. Seller shall comply with all Laws, including, without limitation, the WREGIS Operating Rules, regarding the certification and transfer of such WREGIS Certificates to Buyer and Buyer shall be given sole title to all such WREGIS Certificates. Seller shall be deemed to have satisfied the warranty in Section 4.3.9; provided that Seller fulfills its obligations under Sections 4.3.1 through 4.3.7 below.

4.3.1. Within thirty (30) days of the Commercial Operation Date, Seller shall register the Project with WREGIS and establish an account with WREGIS ("Seller's WREGIS Account"), which Seller shall maintain until the end of the Delivery Term. Seller shall transfer the WREGIS Certificates using "Forward Certificate Transfers" (as described in the WREGIS Operating Rules) from Seller's WREGIS Account to the WREGIS account(s) of Buyer or the account(s) of a designee that Buyer identifies by Notice to Seller ("Buyer's WREGIS Account"). Seller shall be responsible for all expenses associated with registering the Project with WREGIS, establishing and maintaining Seller's WREGIS Account, paying WREGIS Certificate issuance and transfer fees, and transferring WREGIS Certificates from Seller's WREGIS Account to Buyer's WREGIS Account.

4.3.2. Seller shall cause Forward Certificate Transfers to occur on a monthly basis in accordance with the certification procedure established by the WREGIS Operating Rules. Since WREGIS Certificates will only be created for whole MWh amounts of Energy generated, any fractional MWh amounts (i.e., kWh) will be carried forward until sufficient generation is accumulated for the creation of a WREGIS Certificate.

4.3.3. Seller shall, at its sole expense, ensure that the WREGIS Certificates for a given calendar month correspond with the Delivered Energy for such calendar month as evidenced by the Project's metered data.



RENEWABLE MARKET ADJUSTING TARIFF POWER PURCHASE AGREEMENT

- 4.3.4. Due to the ninety (90) day delay in the creation of WREGIS Certificates relative to the timing of invoice payment under Section 3.7, Buyer shall pay an invoice payment for a given month in accordance Section 3.7 before the WREGIS Certificates for such month are formally transferred to Buyer in accordance with the WREGIS Operating Rules and this Section 4.3. Notwithstanding this delay, Buyer shall have all right and title to all such WREGIS Certificates upon payment to Seller in accordance with Section 3.7.
- 4.3.5. A “WREGIS Certificate Deficit” means any deficit or shortfall in WREGIS Certificates delivered to Buyer for a calendar month as compared to the Delivered Energy for the same calendar month (“Deficient Month”). If any WREGIS Certificate Deficit is caused, or the result of any action or inaction, by Seller, then the amount of Delivered Energy in the Deficient Month shall be reduced by the amount of the WREGIS Certificate Deficit for the purposes of calculating Buyer’s payment(s) to Seller under Section 3.7 and the Guaranteed Energy Production for the applicable Performance Measurement Period. Any amount owed by Seller to Buyer because of a WREGIS Certificate Deficit shall be made as an adjustment to Seller’s invoice to Buyer in accordance with Section 3.7, and Buyer shall net such amount against Buyer’s subsequent payment(s) to Seller.
- 4.3.6. Without limiting Seller’s obligations under this Section 4.3, if a WREGIS Certificate Deficit is caused solely by an error or omission of WREGIS, the Parties shall cooperate in good faith to cause WREGIS to correct its error or omission.
- 4.3.7. If WREGIS changes the WREGIS Operating Rules after the Execution Date or applies the WREGIS Operating Rules in a manner inconsistent with this Section 4.3 after the Execution Date, the Parties promptly shall modify this Section 4.3 as reasonably required to cause and enable Seller to transfer to Buyer’s WREGIS Account a quantity of WREGIS Certificates for each given calendar month that corresponds to the Delivered Energy in the same calendar month.
- 4.3.8. Buyer, at its sole discretion, shall have the right to direct Seller to cause and allow Buyer to be the “Qualified Reporting Entity” and “Account Holder” (as such terms are defined by WREGIS) for the Facility.
- 4.3.9. Seller warrants that all necessary steps to allow the Renewable Energy Credits transferred to Buyer to be tracked in the Western Renewable Energy Generation Information System will be taken prior to the first delivery under the contract. [Standard term and condition

RENEWABLE MARKET ADJUSTING TARIFF

POWER PURCHASE AGREEMENT

that “may not be modified” pursuant to prior Commission decisions, including Decision 07-11-025, Decision 08-08-028 and Decision 10-03-021, as modified by Decision 11-01-025]

4.3 WREGIS. [*WREGIS Requirements for Facilities that are (1) less than 1 MW and (2) ineligible for a CAISO revenue meter.*] With respect to WREGIS, Seller shall cause and allow Buyer to be the “Qualified Reporting Entity” and “Account Holder” (as such terms are defined by WREGIS) for the Facility within thirty (30) days after the Commercial Operation Date.

4.4. Resource Adequacy Benefits.

4.4.1. During the Delivery Term, Seller grants, pledges, assigns and otherwise commits to Buyer all of the Contract Capacity, including Capacity Attributes, if any, from the Project to enable Buyer to meet its Resource Adequacy or successor program requirements, as the CPUC, CAISO or other regional entity may prescribe (“Resource Adequacy Requirements”).

4.4.2. If providing any Resource Adequacy, Seller shall comply with the Resource Adequacy requirements set forth in the CAISO Tariff, including Section 40 thereof, as may be changed from time to time.

4.4.3. Seller shall have the option but not the obligation to pursue Full Capacity Deliverability Status for the Project. If the Project achieves Full Capacity Deliverability Status, Seller, at its option, may make a one-time, irrevocable election to utilize the full capacity deliverability payment allocation factors set forth in Appendix C by providing Notice to Buyer of such election within sixty (60) days of achieving Full Capacity Deliverability Status (the “Full Capacity Option Notice”), which election shall be effective as specified in the definition of “Payment Allocation Factors.”

4.4.4. Seller shall cooperate in good faith with, and comply with unburdensome requests of, Buyer and the CAISO to enable Buyer and/or the CAISO to assign Capacity Attributes and Resource Adequacy Benefits to the Facility.

4.5. Eligible Renewable Resource. Seller shall take all actions necessary to achieve and maintain status as an Eligible Renewable Energy Resource or ERR. Within thirty (30) days after the Commercial Operation Date, Seller shall file an application or other appropriate request with the CEC for CEC Certification for the Facility. Seller shall expeditiously seek CEC Certification, including promptly responding to any requests for information from the requesting authority.



RENEWABLE MARKET ADJUSTING TARIFF POWER PURCHASE AGREEMENT

- 4.6. Compliance Expenditure Cap. If Seller establishes to Buyer's reasonable satisfaction that a change in Laws occurring after the Execution Date has increased Seller's cost above the cost that could reasonably have been contemplated as of the Execution Date to take all actions to comply with Seller's obligations under the Agreement with respect to obtaining and maintaining CEC Pre-Certification, CEC Certification or CEC Verification, then Seller's required out-of-pocket expenses are limited to Twenty-Five Thousand dollars (\$25,000.00) in the aggregate each year of the Term ("Compliance Expenditure Cap") between the Execution Date and the last day of the Term.
- 4.6.1. Any actions required for Seller to comply with its obligations set forth in Section 4.6, the cost of which will be included in the Compliance Expenditure Cap, shall be referred to collectively as the "Compliance Actions."
- 4.6.2. If Seller reasonably anticipates the need to incur out-of-pocket expenses in excess of the Compliance Expenditure Cap in order to take any Compliance Action, Seller shall promptly provide Notice to Buyer and documentation to demonstrate the expenses incurred up to the Compliance Expenditure Cap and such anticipated out-of-pocket expenses.
- 4.6.3. Buyer will have ninety (90) days to evaluate such Notice and documentation (during which time period Seller is not obligated to take any Compliance Actions described in the Notice) and shall, within such time, either (a) agree to reimburse Seller for all or some portion of the costs that exceed the Compliance Expenditure Cap (such Buyer-agreed upon costs, the "Accepted Compliance Costs"), or (b) waive Seller's obligation to take such Compliance Actions, or any part thereof for which Buyer has not agreed to reimburse Seller. Notwithstanding the foregoing, if Buyer, in its sole discretion, elects to seek CPUC approval before Buyer agrees to reimburse anticipated out-of-pocket expenses that exceed the Compliance Expenditure Cap or waive Seller's obligation to take such Compliance Actions, Buyer may seek CPUC approval, during which time period Seller is not obligated to take any Compliance Actions described in the Notice.
- 4.6.4. If Buyer agrees to reimburse Seller for the Accepted Compliance Costs, then Seller shall take such Compliance Actions covered by the Accepted Compliance Costs as agreed upon by the Parties and Buyer shall reimburse Seller for Seller's actual costs to effect the Compliance Actions, not to exceed the Accepted Compliance Costs.
- 4.7. Eligible Intermittent Resources Protocol Requirements. If at any time during the Term the Facility is eligible for EIRP, Seller shall provide Buyer



RENEWABLE MARKET ADJUSTING TARIFF POWER PURCHASE AGREEMENT

with a copy of the notice from CAISO certifying the Facility as a Participating Intermittent Resource as soon as practicable after Seller's receipt of such notice of certification. Following such certification: (a) Seller, at its sole cost, shall participate in and comply with EIRP and all additional protocols issued by the CAISO for a Participating Intermittent Resource (if directed by Buyer, in its sole discretion, to participate in such program) or, if the EIRP is no longer available by the CAISO, then all protocols, rules or regulations issued by the CAISO for generating facilities providing energy on an intermittent basis; and (b) Buyer in its limited capacity as Seller's Scheduling Coordinator shall facilitate communication with the CAISO and provide other administrative materials to the CAISO as necessary to satisfy Seller's obligations and to the extent such actions are at de minimis cost to Buyer.

- 4.8. FERC Qualifying Facility Status. Seller shall take all actions, including making or supporting timely filings with the FERC necessary to obtain or maintain the Qualifying Facility status of the Facility throughout the Term; provided, however, that this obligation does not apply to the extent Seller is unable to maintain Qualifying Facility status using commercially reasonable efforts because of (a) a change in PURPA or in regulations of the FERC implementing PURPA occurring after the Execution Date, or (b) a change in Laws directly impacting the Qualifying Facility status of the Facility occurring after the Execution Date; and provided further that Seller shall not be obligated under this Section 4.8 to take any actions or make any filings to the extent that no action or filing is required by FERC to obtain, or maintain the Qualifying Facility status of the Facility.

5. REPRESENTATION AND WARRANTIES; COVENANTS

- 5.1. Representations and Warranties. On the Execution Date, each Party represents and warrants to the other Party that:
- 5.1.1. it is duly organized, validly existing and in good standing under the Laws of the jurisdiction of its formation;
 - 5.1.2. the execution, delivery and performance of this Agreement are within its powers, have been duly authorized by all necessary action and do not violate any of the terms and conditions in its governing documents, any contracts to which it is a party or any Laws;
 - 5.1.3. this Agreement and each other document executed and delivered in accordance with this Agreement constitutes a legally valid and binding obligation enforceable against it in accordance with its terms;
 - 5.1.4. it is not Bankrupt and there are no proceedings pending or being contemplated by it or, to its knowledge, threatened against it which would result in it being or becoming Bankrupt; and



RENEWABLE MARKET ADJUSTING TARIFF POWER PURCHASE AGREEMENT

- 5.1.5. there is not pending or, to its knowledge, threatened against it or any of its Affiliates any legal proceedings that could materially adversely affect its ability to perform its obligations under this Agreement.
- 5.2. General Covenants. Each Party covenants that throughout the Term of this Agreement:
- 5.2.1. it shall continue to be duly organized, validly existing and in good standing under the Laws of the jurisdiction of its formation;
- 5.2.2. it shall maintain (or obtain from time to time as required, including through renewal, as applicable) all regulatory authorizations necessary for it to legally perform its obligations under this Agreement; and
- 5.2.3. it shall perform its obligations under this Agreement in a manner that does not violate any of the terms and conditions in its governing documents, any contracts to which it is a party, or any Law.
- 5.3. Seller's Representations, Warranties and Covenants. In addition to the representations, warranties and covenants specified in Sections 5.1 and 5.2, Seller makes the following additional representations, warranties and covenants to Buyer, as of the Execution Date:
- 5.3.1. Seller has not participated in the Self-Generation Incentive Program (as defined in CPUC Decision 01-03-073), the California Solar Initiative (as defined in CPUC Decision 06-01-024), and/or other similar California ratepayer subsidized program relating to energy production or rebated capacity costs with respect to the Facility or ten (10) years have elapsed from the date Seller first received an incentive or benefit under any such program with respect to the Facility;
- 5.3.2. Seller's execution of this Agreement will not violate Public Utilities Code Section 2821(d)(1), if applicable;
- 5.3.3. Seller, and, if applicable, its successors, represents and warrants that throughout the Delivery Term of this Agreement that: (i) the Project qualifies and is certified by the CEC as an Eligible Renewable Energy Resource ("ERR") as such term is defined in Public Utilities Code Section 399.12 or Section 399.16; and (ii) the Project's output delivered to Buyer qualifies under the requirements of the California Renewables Portfolio Standard. To the extent a change in law occurs after execution of this Agreement that causes this representation and warranty to be materially false or misleading, it shall not be an Event of Default if Seller has used commercially reasonable efforts to comply with such change in law; [Standard term

RENEWABLE MARKET ADJUSTING TARIFF POWER PURCHASE AGREEMENT

and condition that “may not be modified” pursuant to prior Commission decisions, including Decision 07-11-025, Decision 08-08-028 and Decision 10-03-021, as modified by Decision 11-01-025]

5.3.4. Seller and, if applicable, its successors, represents and warrants that throughout the Delivery Term of this Agreement the Renewable Energy Credits transferred to Buyer conform to the definition and attributes required for compliance with the California Renewables Portfolio Standard, as set forth in California Public Utilities Commission Decision 08-08-028, and as may be modified by subsequent decision of the California Public Utilities Commission or by subsequent legislation. To the extent a change in law occurs after execution of this Agreement that causes this representation and warranty to be materially false or misleading, it shall not be an Event of Default if Seller has used commercially reasonable efforts to comply with such change in law; [Standard term and condition that “may not be modified” pursuant to prior Commission decisions, including Decision 07-11-025, Decision 08-08-028 and Decision 10-03-021, as modified by Decision 11-01-025]

5.3.5. The term “commercially reasonable efforts” as used in Section 5.3.3 and 5.3.4 means efforts consistent with and subject to Section 4.6;

5.3.6. Subject to Section 4.8, throughout the Term of this Agreement, the Facility shall qualify as a Qualifying Facility.

5.3.7. Throughout the Term, Seller shall: (a) own and operate the Facility; (b) deliver the Product to Buyer to the Delivery Point free and clear of all liens, security interests, claims and encumbrances or any interest therein or thereto by any individual or entity; and (c) hold the rights to all of the Product;

5.3.8. Seller is acting for its own account, has made its own independent decision to enter into this Agreement and as to whether this Agreement is appropriate or proper for it based upon its own judgment, is not relying upon the advice or recommendations of the Buyer in so doing, and is capable of assessing the merits of, and understands and accepts, the terms, conditions and risks of this Agreement;

5.3.9. Throughout the Delivery Term: (a) Seller will not convey, transfer, allocate, designate, award, report or otherwise provide any or all of the Product, or any portion thereof, or any benefits derived therefrom, to any party other than Buyer; and (b) Seller will not start-up or operate the Facility per instruction of or for the benefit of any third

RENEWABLE MARKET ADJUSTING TARIFF POWER PURCHASE AGREEMENT

party, except as required by other Laws or, in the case of excess sale arrangements, to serve any Site Host Load;

5.3.10. Seller has not relied on any promises, representations, statements or information of any kind that are not contained in this Agreement in deciding to enter into this Agreement;

5.3.11. The construction of the Facility shall comply with all Laws, including applicable state and local laws, building standards, and interconnection requirements;

5.3.12. No other person or entity, including any other generating facility has any rights in connection with Seller's interconnection agreement or Seller's Interconnection Facilities and no other persons or entities shall have any such rights during the Term; and

5.3.13. During the Term, Seller shall not allow any other person or entity, including any other generating facility, to use Seller's Interconnection Facilities.

6. GENERAL CONDITIONS

6.1. CAISO Agreements; Interconnection Agreements; Scheduling. During the Delivery Term, Seller shall operate the Facility in compliance with the Transmission/Distribution Owner tariffs, the CAISO Tariff, and all Laws. Seller shall secure and maintain in full force all of the CAISO agreements, certifications and approvals required in order for the Facility to comply with the CAISO Tariff, including executing and maintaining, as applicable, a Participating Generator Agreement, Meter Service Agreement, interconnection agreement, and/or any other agreement necessary to deliver the Product to Buyer. Seller shall also comply with any modifications, amendments or additions to the applicable tariffs, protocols and Laws; provided that Seller shall be required to enter into a Participating Generator Agreement with the CAISO only if the Facility's net capacity is 500 kW or greater or if the CAISO Tariff requires or provides Seller the option to enter into such an agreement. Seller shall arrange and pay independently for any and all necessary costs under a Participating Generator Agreement, Meter Service Agreement, interconnection agreement, and/or any other agreement necessary to deliver the Product to Buyer. Ninety (90) days prior to the Commercial Operation Date, Seller must provide Buyer with all operating information, consistent with manufacturers specifications, needed for the Buyer to register the Facility with the CAISO and for Buyer to serve as Scheduling Coordinator.

6.2. Metering Requirements.



RENEWABLE MARKET ADJUSTING TARIFF POWER PURCHASE AGREEMENT

- 6.2.1. All output from the Project must be delivered through a single CAISO revenue meter and that meter must be dedicated exclusively to the Project; provided that if the CAISO does not permit a revenue meter for the Facility, the Buyer shall specify a revenue quality meter for the Facility. All Product purchased under this Agreement must be measured by the Project's CAISO revenue meter(s), or the revenue quality meter specified by Buyer, to be eligible for payment under this Agreement. Seller shall bear all costs relating to all metering equipment installed to accommodate the Project.
- 6.2.2. Buyer may, at its sole cost, furnish and install one Check Meter at the interconnection associated with the Facility at a location provided by Seller that is compliant with Buyer's electric service requirements. The Check Meter must be interconnected with Buyer's communication network to permit (a) periodic, remote collection of revenue quality meter data, and (b) back-up real time transmission of operating-quality meter data through the telemetering system. In the event that Buyer elects to install a Check Meter, Buyer may compare the Check Meter data to the CAISO meter data. If the deviation between the CAISO meter data and the Check Meter data for any comparison is greater than 0.3%, Buyer may provide Notice to Seller of such deviation and the Parties shall mutually arrange for a meter check or recertification of the Check Meter or CAISO meter, as applicable. Each Party shall bear its own costs for any meter check or recertification. Testing procedures and standards for the Check Meter will be the same as for a comparable Buyer-owned meter. Seller shall have the right to have representatives present during all such tests. The Check Meter, if Buyer elects to install a Check Meter, is intended to be used for back-up purposes in the event of a failure or other malfunction of the CAISO meter, and Check Meter data shall only be used to validate the CAISO meter data and, in the event of a failure or other malfunction of the CAISO meter, in place of the CAISO meter until such time that the CAISO meter is recertified.
- 6.2.3. In the case of excess sales arrangements, Buyer may, at its sole cost, furnish and install a net generation output meter at a location provided by Seller that is compliant with Buyer's electric service requirements. Such meter must be interconnected with Buyer's communication network to permit (a) periodic, remote collection of revenue quality meter data, and (b) back-up real time transmission of operating-quality meter data through the telemetering system.
- 6.3. Meter Data. Seller hereby agrees to provide all meter data to Buyer in a form acceptable to Buyer, and consents to Buyer obtaining from the CAISO the CAISO meter data applicable to the Project and all inspection, testing and calibration data and reports. Seller shall grant Buyer the right to



RENEWABLE MARKET ADJUSTING TARIFF POWER PURCHASE AGREEMENT

retrieve the meter readings from the CAISO Operational Meter Analysis and Reporting website and directly from the meter(s) at the Site.

- 6.4. Standard of Care. Seller shall: (a) maintain and operate the Facility and Interconnection Facilities, except facilities installed by Buyer, in conformance with all Laws and in accordance with Prudent Electrical Practices; (b) obtain any governmental authorizations and permits required for the construction and operation thereof; and (c) generate, schedule and perform transmission services in compliance with all applicable operating policies, criteria, rules, guidelines and tariffs and Prudent Electrical Practices. Seller shall reimburse Buyer for any and all losses, damages, claims, penalties, or liability Buyer incurs as a result of Seller's failure to obtain or maintain any governmental authorizations and permits required for construction and operation of the Facility throughout the Term of this Agreement.
- 6.5. Access Rights.
- 6.5.1. Operations Logs. Seller shall maintain a complete and accurate log of all material operations and maintenance information on a daily basis. Such log shall include, but not be limited to, information on power production, fuel consumption (if applicable), efficiency, availability, maintenance performed, outages, results of inspections, manufacturer recommended services, replacements, electrical characteristics of the generators, control settings or adjustments of equipment and protective devices. Seller shall provide this information electronically to Buyer within twenty (20) days of Buyer's request.
- 6.5.2. Access Rights. Buyer, its authorized agents, employees and inspectors may, on reasonable advance notice under the circumstances, visit the Project during normal business hours for purposes reasonably connected with this Agreement or the exercise of any and all rights secured to Buyer by Law, its tariff schedules, and rules on file with the CPUC. Buyer, its authorized agents, employees and inspectors must (a) at all times adhere to all safety and security procedures as may be required by Seller; and (b) not interfere with the operation of the Project. Buyer shall make reasonable efforts to coordinate its emergency activities with the Safety and Security Departments, if any, of the Project operator. Seller shall keep Buyer advised of current procedures for contacting the Project operator's Safety and Security Departments.
- 6.6. Protection of Property. Each Party shall be responsible for protecting its own facilities from possible damage resulting from electrical disturbances or faults caused by the operation, faulty operation, or non-operation of the



RENEWABLE MARKET ADJUSTING TARIFF POWER PURCHASE AGREEMENT

other Party's facilities and such other Party shall not be liable for any such damages so caused; provided that nothing in this Section 6.6 shall modify any other agreement between the Parties.

6.7. Performance Excuses.

6.7.1. Seller Excuses. Seller shall be excused from achieving the Guaranteed Energy Production during Seller Excuse Hours, as provided in Section 12.1.

6.7.2. Buyer Excuses. The obligation of Buyer to receive and/or pay for the Product shall be excused only (a) during periods of Force Majeure, (b) by Seller's failure to perform, or (c) as provided with respect to curtailment in Section 6.8.

6.8. Seller Curtailment.

6.8.1. Seller shall curtail the production of the Facility in accordance with the applicable Notice after receipt of: (a) Notice from Buyer that Buyer has been instructed by the CAISO or the Transmission/Distribution Owner to curtail Energy deliveries; (b) Notice that Seller has been given a curtailment order or similar instruction in order to respond to an Emergency; (c) Notice of a Curtailment Order issued by Buyer.

6.8.2. Buyer shall have no obligation to pay Seller for any Product delivered in violation of Section 6.8 or for any Product that Seller would have been able to deliver but for the fact of a curtailment pursuant to Section 6.8.1(a) or (b). Seller shall assume all liability and reimburse Buyer for any and all costs and charges incurred by Buyer, including but not limited to CAISO Penalties, as a result of Seller delivering Energy in violation of Section 6.8.

6.8.3. Buyer shall have the right, but not the obligation, to issue to Seller a Curtailment Order. Buyer shall pay Seller the Contract Price for the Product Seller would have been able to deliver but for the fact that Buyer issued a Curtailment Order ("Paid Curtailed Product").

6.8.4. Buyer shall estimate the amount of Product the Facility would have been able to deliver under Sections 6.8.3. Buyer shall apply accepted industry standards in making such an estimate and take into consideration past performance of the Facility, meteorological data, solar irradiance data, and any other relevant information. Seller shall cooperate with Buyer's requests for information associated with any estimate made hereunder. Buyer's estimates under this Section 6.8.4 for the amount of Product that the Facility would have been able to deliver but for Buyer's issuance of a Curtailment Order will be determined in Buyer's reasonable discretion.



RENEWABLE MARKET ADJUSTING TARIFF POWER PURCHASE AGREEMENT

- 6.9. Forecasting and Outage Notifications. Seller shall comply with the forecasting and outage notifications in Appendix D.
- 6.10. Telemetry Requirements. Seller shall comply with the telemetry requirements in Appendix F.
- 6.11. Greenhouse Gas Emissions. Seller acknowledges that a Governmental Authority may require Buyer to take certain actions with respect to greenhouse gas emissions attributable to the generation of Energy, including, but not limited to, reporting, registering, tracking, allocating for or accounting for such emissions. Promptly following Buyer's written request, Seller agrees to take all commercially reasonable actions and execute or provide any and all documents, information or instruments with respect to generation by the Facility reasonably necessary to permit Buyer to comply with such requirements, if any.
- 6.12. Reporting and Record Retention.
- 6.12.1. Seller shall use commercially reasonable efforts to meet the Milestone Schedule set forth in Appendix I and avoid or minimize any delays in meeting such schedule. Seller shall provide Project development status reports in a format and a frequency, which shall not exceed one (1) report per month, specified by the Buyer. The report shall describe Seller's progress relative to the development, construction, and startup of the Facility, as well as a Notice of any anticipated change to the Commercial Operation Date and whether Seller is on schedule to meet the Guaranteed Commercial Operation Date.
- 6.12.2. Seller shall within ten (10) Business Days of receipt thereof provide to Buyer copies of any Interconnection Study or the interconnection agreement tendered to Seller by the CAISO or the Transmission/Distribution Owner and all other material reports, studies and analyses furnished by the CAISO or any Transmission/Distribution Owner, and any correspondence with the CAISO or Transmission/Distribution Owner related thereto, concerning the interconnection of the Facility to the Transmission/Distribution Owner's electric system or the transmission of Energy on the Transmission/Distribution Owners' electric system. Concurrently with the provision of any Interconnection Study or the interconnection agreement tendered to Seller by the CAISO or the Transmission/Distribution Owner that may give rise to a termination right of Buyer under Section 14.9.1, Seller shall provide Buyer a Notice of its irrevocable election to exercise or not exercise its rights under Section 14.9.2, with a failure to provide such an election deemed to be an election not to exercise such rights.

RENEWABLE MARKET ADJUSTING TARIFF POWER PURCHASE AGREEMENT

- 6.12.3. No later than twenty (20) days after each semi-annual period ending on June 30th or December 31st, Seller shall provide a report listing all WMDVBES that supplied goods or services to Seller during such period, including any certifications or other documentation of such WMDVBES' status as such and the aggregate amount paid to WMDVBES during such period.
- 6.12.4. Seller shall provide to Buyer on the Commercial Operation Date, and within thirty (30) days after the completion of each Contract Year thereafter during the Delivery Term, an inspection and maintenance report regarding the Facility. Buyer shall provide to the Seller a form inspection and maintenance report before the Commercial Operation Date and Seller shall complete the form inspection and maintenance report. Buyer, at its sole discretion, may modify the form inspection and maintenance report to be used in subsequent Contract Years during the Delivery Term.
- 6.12.5. Seller shall keep all operating records required of a Qualifying Facility by any applicable CPUC order as well as any additional information that may be required of a Qualifying Facility in order to demonstrate compliance with all applicable standards which have been adopted by the CPUC.
- 6.12.6. If the Facility is a "qualifying cogeneration facility" as contemplated in 18 CFR Section 292.205, then within thirty (30) days following the end of each calendar year, and within thirty (30) days following the end of the Delivery Term, Seller shall provide to Buyer:
- 6.12.6.1. A copy of a FERC order waiving for the Facility, the applicable operating and efficiency standards for qualifying cogeneration facilities for the applicable year; or
- 6.12.6.2. A completed copy of Buyer's "QF Efficiency Monitoring Program – Cogeneration Data Reporting Form," substantially in the form of Appendix N-1, with calculations and verifiable supporting data, which demonstrates the compliance of the Facility with cogeneration Qualifying Facility operating and efficiency standards set forth in 18 CFR Section 292.205 "Criteria for Qualifying Cogeneration Facilities," for the applicable year.
- 6.12.7. If the Facility is a "qualifying small power production facility" as contemplated in 18 CFR Section Sections 292.203(a), 292.203(c) and 292.204, then within thirty (30) days following the end of each year, and within thirty (30) days following the end of the Delivery Term, Seller shall provide to Buyer:



RENEWABLE MARKET ADJUSTING TARIFF POWER PURCHASE AGREEMENT

- 6.12.7.1. A copy of a FERC order waiving for the Facility, the applicable operating and fuel use standards for qualifying small power production facilities for the applicable year; or
- 6.12.7.2. A completed copy of Buyer's "Fuel Use Standards – Small Power Producer Data Reporting Form," substantially in the form of Appendix N-2, with calculations and verifiable supporting data, which demonstrates the compliance of the Facility with small power producer Qualifying Facility fuel use standards set forth in 18 CFR Section 292.204 "Criteria for Qualifying Small Power Production Facilities," for the applicable year.
- 6.13. Tax Withholding Documentation. Upon Buyer's request, Seller shall promptly provide to Buyer Internal Revenue Service tax Form W-9 and California tax Form 590 (or their equivalent), completed with Seller's information, and any other documentation necessary for Buyer to comply with its tax reporting or withholding obligations with respect to Seller.
- 6.14. Modifications to Facility. During the Delivery Term, Seller shall not repower or materially modify or alter the Facility without the written consent of Buyer, which written consent is at Buyer's sole discretion. Material modifications or alterations include, but are not limited to, (a) movement of the Site, (b) changes that may increase or decrease the expected output of the Facility (other than a one (1) time decrease based upon any adjustment to the Contract Capacity based on the Demonstrated Contract Capacity), (c) changes that may affect the generation profile of the Facility, (d) changes that may affect the ability to accurately measure the output of Product from the Facility and (e) changes that conflict with elections, information or requirements specified elsewhere in this Agreement (other than, to the extent not covered by clauses (a) through (d), as specified in Appendix E). Material modifications or alterations do not include maintenance and repairs performed in accordance with Prudent Electrical Practices. Seller shall provide to Buyer Notice not less than ninety (90) days before any proposed repowering, modification or alteration occurs describing the repowering, modification or alteration to Buyer's reasonable satisfaction and, if subject to Buyer's consent pursuant to this Section 6.14, seeking Buyer's written consent.
- 6.15. No Additional Incentives. Seller agrees that during the Term of this Agreement it shall not seek additional compensation or other benefits pursuant to the Self-Generation Incentive Program, as defined in CPUC Decision 01-03-073, the California Solar Initiative, as defined in CPUC Decision 06-01-024, Buyer's net energy metering tariff, or other similar California ratepayer subsidized program relating to energy production with respect to the Facility.



RENEWABLE MARKET ADJUSTING TARIFF POWER PURCHASE AGREEMENT

- 6.16. Small Hydro/Private Energy Producer. Seller agrees to provide to Buyer copies of each of the documents identified in California Public Utilities Code Section 2821(d)(1), if applicable, as may be amended from time to time, as evidence of Seller's compliance with such Public Utilities Code section prior to the Commercial Operation Date and, after the Commercial Operation Date, within thirty (30) days of Seller's receipt of written request.
- 6.17. Site Control. Seller shall have Site Control as of the earlier of: (a) the Commercial Operation Date; or (b) any date before the Commercial Operation Date to the extent necessary for the Seller to perform its obligations under this Agreement and, in each case, Seller shall maintain Site Control throughout the Delivery Term. Seller shall promptly provide Buyer with Notice if there is any change in the status of Seller's Site Control.

7. INDEMNITY

- 7.1. Each Party as indemnitor shall defend, save harmless and indemnify the other Party and the directors, officers, and employees of such other Party against and from any and all loss and liability (including reasonable attorneys' fees) for injuries to persons, including employees of either Party, and physical damage to property, including property of either Party, resulting from or arising out of: (a) the engineering, design, construction, maintenance, or operation of the indemnitor's facilities; (b) the installation of replacements, additions, or betterments to the indemnitor's facilities; or (c) the negligence or willful misconduct of the indemnitor relating to its obligation under this Agreement. This indemnity and save harmless provision shall apply notwithstanding the active or passive negligence of the indemnitee. Neither Party shall be indemnified for liability or loss, resulting from its sole negligence or willful misconduct. The indemnitor shall, on the other Party's request, defend any suit asserting a claim covered by this indemnity and shall pay all costs, including reasonable attorneys' fees that may be incurred by the other Party in enforcing this indemnity.
- 7.2. Each Party shall defend, save harmless and indemnify the other Party, its directors, officers, employees, and agents, assigns, and successors in interest, for and against any penalty imposed upon the Party to the extent caused by the other Party's failure to fulfill its obligations under this Agreement.
- 7.3. Each Party releases and shall defend, save harmless and indemnify the other Party from any and all loss and liability (including reasonable attorneys' fees) in connection with any breach made by the indemnifying Party of its representations, warranties and covenants in this Agreement.



RENEWABLE MARKET ADJUSTING TARIFF POWER PURCHASE AGREEMENT

8. LIMITATION OF DAMAGES

EXCEPT AS OTHERWISE PROVIDED IN THIS AGREEMENT THERE IS NO WARRANTY OF MERCHANTABILITY OR FITNESS FOR A PARTICULAR PURPOSE, AND ANY AND ALL IMPLIED WARRANTIES ARE DISCLAIMED. LIABILITY SHALL BE LIMITED TO DIRECT ACTUAL DAMAGES ONLY, SUCH DIRECT ACTUAL DAMAGES SHALL BE THE SOLE AND EXCLUSIVE REMEDY AND ALL OTHER REMEDIES OR DAMAGES AT LAW OR IN EQUITY ARE WAIVED UNLESS EXPRESSLY HEREIN PROVIDED. NEITHER PARTY SHALL BE LIABLE FOR CONSEQUENTIAL, INCIDENTAL, PUNITIVE, EXEMPLARY OR INDIRECT DAMAGES, LOST PROFITS OR OTHER BUSINESS INTERRUPTION DAMAGES, BY STATUTE, IN TORT OR CONTRACT, UNDER ANY INDEMNITY PROVISION OR OTHERWISE. UNLESS EXPRESSLY HEREIN PROVIDED, AND SUBJECT TO THE PROVISIONS OF SECTION 7 (INDEMNITY), IT IS THE INTENT OF THE PARTIES THAT THE LIMITATIONS HEREIN IMPOSED ON REMEDIES AND THE MEASURE OF DAMAGES BE WITHOUT REGARD TO THE CAUSE OR CAUSES RELATED THERETO, INCLUDING THE NEGLIGENCE OF ANY PARTY, WHETHER SUCH NEGLIGENCE BE SOLE, JOINT OR CONCURRENT, OR ACTIVE OR PASSIVE.

9. NOTICES

Notices (other than forecasts, scheduling requests and curtailment (or equivalent) instructions) shall, unless otherwise specified herein, be in writing and may be delivered by hand delivery, United States mail, overnight courier service, facsimile or electronic messaging (e-mail). Notices of curtailment (or equivalent orders) may be oral or written and must be made in accordance with accepted industry practices for such notices. A notice sent by facsimile transmission or e-mail will be recognized and shall be deemed received on the Business Day on which such notice was transmitted if received before 5 p.m. Pacific prevailing time (and if received after 5 p.m., on the next Business Day) and a notice by overnight mail or courier shall be deemed to have been received on the next Business Day after such Notice is sent or such earlier time as is confirmed by the receiving Party unless it confirms a prior oral communication, in which case any such notice shall be deemed received on the day sent. A Party may change its addresses by providing notice of same in accordance with this provision. All Notices, requests, invoices, statements or payments for this Facility must reference this Agreement's identification number. Notices shall be provided as indicated in Appendix J.

10. INSURANCE

10.1. Insurance Coverage. Seller shall, at its own expense, starting on the Execution Date and until the end of the Term, and for such additional periods as may be specified below, provide and maintain in effect the following insurance policies and minimum limits of coverage as specified



RENEWABLE MARKET ADJUSTING TARIFF POWER PURCHASE AGREEMENT

below, and such additional coverage as may be required by Law, with insurance companies authorized to do business in the state in which the services are to be performed, with an A.M. Best's Insurance Rating of not less than A-VII.

10.1.1. Commercial general liability insurance, written on an occurrence, not claims-made basis, covering all operations by or on behalf of Seller arising out of or connected with this Agreement, including coverage for bodily injury, broad form property damage, personal and advertising injury, products/completed operations, contractual liability, premises-operations, owners and contractors protective, hazard, explosion, collapse and underground. Such insurance must bear a combined single limit per occurrence and annual aggregate of not less than one million dollars (\$1,000,000.00), exclusive of defense costs, for all coverages. Such insurance must contain standard cross-liability and severability of interest provisions. If Seller elects, with Buyer's written concurrence, to use a "claims made" form of commercial general liability insurance, then the following additional requirements apply: (a) the retroactive date of the policy must be prior to the Execution Date; and (b) either the coverage must be maintained for a period of not less than four (4) years after this Agreement terminates, or the policy must provide for a supplemental extended reporting period of not less than four (4) years after this Agreement terminates. Governmental agencies which have an established record of self-insurance may provide the required coverage through self-insurance.

10.1.2. Workers' compensation insurance with statutory limits, as required by the state having jurisdiction over Seller's employees, and employer's liability insurance with limits of not less than: (a) bodily injury by accident - one million dollars (\$1,000,000.00) each accident; (b) bodily injury by disease - one million dollars (\$1,000,000.00) policy limit; and (c) bodily injury by disease - one million dollars (\$1,000,000.00) each employee.

10.1.3. Commercial automobile liability insurance covering bodily injury and property damage with a combined single limit of not less than one million dollars (\$1,000,000.00) per occurrence. Such insurance must cover liability arising out of Seller's use of all owned, non-owned and hired automobiles in the performance of the Agreement.

10.1.4. Umbrella/excess liability insurance, written on an occurrence, not claims-made basis, providing coverage excess of the underlying employer's liability, commercial general liability, and commercial automobile liability insurance, on terms at least as broad as the

RENEWABLE MARKET ADJUSTING TARIFF POWER PURCHASE AGREEMENT

underlying coverage, with limits of not less than four million dollars (\$4,000,000.00) per occurrence and in the annual aggregate.

10.2. Additional Insurance Provisions.

10.2.1. On or before the later of (a) sixty (60) days after the Execution Date and (b) the date immediately preceding commencement of construction of the Facility, and again within a reasonable time after coverage is renewed or replaced, Seller shall furnish to Buyer certificates of insurance evidencing the coverage required above, written on forms and with deductibles reasonably acceptable to Buyer. Notwithstanding the foregoing sentence, Seller shall in no event furnish Buyer certificates of insurance evidencing required coverage later than the Commercial Operation Date. All deductibles, co-insurance and self-insured retentions applicable to the insurance above must be paid by Seller. All certificates of insurance must note that the insurers issuing coverage must endeavor to provide Buyer with at least thirty (30) days' prior written notice in the event of cancellation of coverage. Buyer's receipt of certificates that do not comply with the requirements stated in this Section 10.2.1, or Seller's failure to provide such certificates, do not limit or relieve Seller of the duties and responsibility of maintaining insurance in compliance with the requirements in this Section 10 and do not constitute a waiver of any of the requirements of Section 10.

10.2.2. Insurance coverage described above in Section 10.1 shall provide for thirty (30) days written Notice to Buyer prior to cancellation, termination, alteration, or material change of such insurance.

10.2.3. Evidence of coverage described above in Section 10.1 shall state that coverage provided in primary and is not excess to or contributing with any insurance or self-insurance maintained by Buyer.

10.2.4. Buyer shall have the right to inspect or obtain a copy of the original policy(ies) of insurance.

10.2.5. All insurance certificates, endorsements, cancellations, terminations, alterations, and material changes of such insurance must be issued, clearly labeled with this Agreement's identification number and submitted in accordance with Section 9 and Appendix J.

10.2.6. The insurance requirements set forth in Section 10.1 will apply as primary insurance to, without a right of contribution from, any other insurance maintained by or afforded to Buyer, its subsidiaries and Affiliates, and their respective officers, directors, shareholders, agents, and employees, regardless of any conflicting provision in Seller's policies to the contrary. To the extent permitted by Law,

RENEWABLE MARKET ADJUSTING TARIFF POWER PURCHASE AGREEMENT

Seller and its insurers shall be required to waive all rights of recovery from or subrogation against Buyer, its subsidiaries and Affiliates, and their respective officers, directors, shareholders, agents, employees and insurers. The commercial general liability insurance required in Section 10.1.1 and the umbrella/excess liability insurance required in Section 10.1.4 must name Buyer, its subsidiaries and Affiliates, and their respective officers, directors, shareholders, agents and employees, as additional insureds for liability arising out of Seller's construction, use or ownership of the Facility.

10.2.7. Seller shall remain liable for all acts, omissions or default of any subcontractor or subsupplier and shall indemnify, defend and hold harmless Buyer for any and all loss or damages, as well as all costs, charges and expenses which Buyer may suffer, incur, or bear as a result of any acts, omissions or default by or on behalf of any subcontractor or subsupplier.

10.2.8. If Seller fails to comply with any of the provisions of this Section 10, Seller, among other things and without restricting Buyer's remedies under Law or otherwise, shall, at its own cost, act as an insurer and provide insurance in accordance with the terms and conditions of this Section 10. With respect to the required commercial general liability insurance set forth in Section 10.1.1, umbrella/excess liability insurance set forth in Section 10.1.4, and commercial automobile liability insurance set forth in Section 10.1.3, Seller shall provide a current, full and complete defense to Buyer, its subsidiaries and Affiliates, and their respective officers, directors, shareholders, agents, employees, assigns, and successors in interest, in response to a third party claim in the same manner that an insurer with an A.M. Best's Insurance Rating of A-:VII would have, had the insurance been maintained in accordance with the terms and conditions set forth in this Section 10 and given the required additional insured wording in the commercial general liability insurance and umbrella/excess liability insurance, and standard "Who is an Insured" provision in commercial automobile liability form.

11. FORCE MAJEURE

11.1. No Default for Force Majeure. Neither Party shall be in default in the performance of any of its obligations set forth in this Agreement, except for obligations to pay money, when and to the extent failure of performance is caused by Force Majeure. Nothing in this Section 11 shall relieve the Seller of the obligation to achieve Commercial Operation on or before the Guaranteed Commercial Operation Date, as may be extended pursuant to Section 2.8.



RENEWABLE MARKET ADJUSTING TARIFF POWER PURCHASE AGREEMENT

- 11.2. Requirements Applicable to Claiming Party. If a Party, because of Force Majeure, is rendered wholly or partly unable to perform its obligations when due under this Agreement, such Party (the “Claiming Party”) shall be excused from whatever performance is affected by the Force Majeure to the extent so affected. In order to be excused from its performance obligations under this Agreement by reason of Force Majeure:
- 11.2.1. The Claiming Party, on or before the fourteenth (14th) day after the initial occurrence of the claimed Force Majeure, must give the other Party Notice describing the particulars of the occurrence; and
- 11.2.2. The Claiming Party must provide timely evidence reasonably sufficient to establish that the occurrence constitutes Force Majeure as defined in this Agreement.
- 11.3. Limitations. The suspension of the Claiming Party’s performance due to Force Majeure may not be greater in scope or longer in duration than is required by such Force Majeure. In addition, the Claiming Party shall use diligent efforts to remedy its inability to perform. When the Claiming Party is able to resume performance of its obligations under this Agreement, the Claiming Party shall give the other Party prompt Notice to that effect.
- 11.4. Termination. Either Party may terminate this Agreement on at least five (5) Business Days’ prior Notice, in the event of Force Majeure which materially interferes with such Party’s ability to perform its obligations under this Agreement and which (a) extends for more than 365 consecutive days, (b) extends for more than a total of 365 days in any consecutive 540-day period, or (c) causes the Commercial Operation Date to fail to be demonstrated by the Guaranteed Commercial Operation Date.

12. GUARANTEED ENERGY PRODUCTION

12.1. General. Throughout the Delivery Term, Seller shall be required to deliver to Buyer no less than the Guaranteed Energy Production over two (2) consecutive Contract Years during the Delivery Term (“Performance Measurement Period”). “Guaranteed Energy Production” means an amount of Delivered Energy, as measured in kWh, equal to the product of (x) and (y), where (x) is:

[one hundred forty percent (140%)] *[for wind As-Available technology]*

[one hundred seventy percent (170%)] *[for all other As-Available technologies]*

[one hundred eighty percent (180%)] *[for Baseload technologies]*

[[spell out or leave blank] percent ([0]%) *[for hydro a threshold reasonably acceptable to Buyer based on Facility characteristics to be proposed by hydro Seller]*

of the average of the Contract Quantity over the Performance Measurement Period and (y) is the difference between (I) and (II), with the resulting difference divided by (I), where (I) is the number of hours in the applicable Performance Measurement Period and (II) is the aggregate number of Seller Excuse Hours in the applicable Performance Measurement Period. Guaranteed Energy Production is described by the following formula:

*Guaranteed Energy Production = (170 *[insert percentage from above]* % * average of the Contract Quantity over the Performance Measurement Period in kWh) * [(Hrs in Performance Measurement Period - Seller Excuse Hrs) / Hrs in Performance Measurement Period]*

12.2. GEP Failures. If Seller has a GEP Failure, then within ninety (90) days after the last day of the last month of such Performance Measurement Period, Buyer shall notify Seller of such failure. Seller shall cure the GEP Failure by delivering to Buyer GEP Damages, calculated pursuant to Appendix G, within thirty (30) days of receipt of the Notice.

12.3. GEP Damages. The Parties agree that the damages sustained by Buyer associated with Seller’s failure to achieve the Guaranteed Energy Production requirement would be difficult or impossible to determine, or that obtaining an adequate remedy would be unreasonably time consuming or expensive and therefore agree that Seller shall pay the GEP Damages to

RENEWABLE MARKET ADJUSTING TARIFF

POWER PURCHASE AGREEMENT

Buyer as liquidated damages. In no event shall Buyer be obligated to pay GEP Damages.

13. CREDIT AND COLLATERAL REQUIREMENTS

- 13.1. Collateral Requirement. On or before the thirtieth (30th) day following the Execution Date, Seller shall post and thereafter maintain a collateral requirement (the "Collateral Requirement") equal to twenty dollars (\$20.00) for each kilowatt of the Contract Capacity. The Collateral Requirement will be held by Buyer and must be in the form of either a cash deposit or Letter of Credit.
- 13.2. Maintenance of Collateral Requirement. The Collateral Requirement shall be posted to Buyer and maintained at all times from the thirtieth (30th) day following the Execution Date through the end of the Term and thereafter until such time as Seller has satisfied all monetary obligations which survive any termination of this Agreement, not to exceed one year following the end of the Term. In the event that Buyer draws on the Collateral Requirement pursuant to this Agreement, Seller shall promptly replenish such Collateral Requirement to the amount specified in Section 13.1, as may be adjusted pursuant to Section 13.3.
- 13.3. Forfeiture Based on Capacity. If, on the earlier of the Commercial Operation Date or the Guaranteed Commercial Operation Date, Seller:
- 13.3.1. is not capable of delivering any of the Contract Capacity to the Delivery Point, as determined by Buyer in its reasonable discretion, Seller shall forfeit, and Buyer shall be entitled to, the entire Collateral Requirement and Buyer may terminate this Agreement; or
- 13.3.2. is only capable of delivering a portion of the Contract Capacity to the Delivery Point, based on the Demonstrated Contract Capacity, Seller shall forfeit, and Buyer shall have the right to retain, a portion of the Collateral Requirement equal to the product of (a) twenty dollars (\$20.00), multiplied by (b) the Contract Capacity set forth in Section 3.1 less the Demonstrated Contract Capacity.
- 13.4. Grant of Security Interest/Remedies. To secure its obligations under this Agreement and to the extent Seller delivers the Collateral Requirement, as applicable, hereunder, Seller hereby grants to Buyer, as the secured party, a first priority security interest in, and lien on (and right of setoff against), and assignment of, all such Collateral Requirement posted with Buyer in the form of cash or Letter of Credit and any and all proceeds resulting therefrom or the liquidation thereof, whether now or hereafter held by, on behalf of, or for the benefit of, Buyer. Within thirty (30) days of the delivery of the Collateral Requirement, Seller agrees to take such action as Buyer reasonably requires in order to perfect a first-priority security interest in, and



RENEWABLE MARKET ADJUSTING TARIFF POWER PURCHASE AGREEMENT

lien on (and right of setoff against), such Collateral Requirement and any and all proceeds resulting therefrom or from the liquidation thereof. Upon or any time after the occurrence of an Event of Default, an Early Termination Date or an occasion provided for in this Agreement where Buyer is authorized to retain all or a portion of the Collateral Requirement, Buyer may do any one or more of the following: (a) exercise any of the rights and remedies of a secured party with respect to the Collateral Requirement, as applicable, including any such rights and remedies under Law then in effect; (b) exercise its rights of setoff against any and all property of Seller in the possession of the Buyer or Buyer's agent; (c) draw on any outstanding Letter of Credit issued for its benefit or retain any cash deposit; and (d) liquidate the Collateral Requirement then held by or for the benefit of Buyer free from any claim or right of any nature whatsoever of Seller, including any equity or right of purchase or redemption by Seller. Buyer shall apply the proceeds of the collateral realized upon the exercise of any such rights or remedies to reduce Seller's obligations under the Agreement (Seller remaining liable for any amounts owing to Buyer after such application), subject to the Buyer's obligation to return any surplus proceeds remaining after such obligations are satisfied in full.

13.5. Use of Collateral Requirement. Buyer shall be entitled draw upon the Collateral Requirement for any damages arising upon Buyer's declaration of an Early Termination Date or as set forth in Section 13.3.1 and 13.3.2. If Buyer terminates this Agreement and is entitled to draw upon the Collateral Requirement, any amount of Collateral Requirement that Seller has not yet posted with Buyer will be immediately due and payable by Seller to Buyer.

13.5.1. Return of Collateral Requirement. Buyer shall return the unused portion of the Collateral Requirement, including the payment of any interest due thereon to Seller promptly after the following has occurred: (a) the Term of the Agreement has ended, or an Early Termination Date has occurred, as applicable; and (b) all payment obligations of the Seller arising under this Agreement, including but not limited to payments pursuant to the Settlement Amount, indemnification payments, or other damages are paid in full (whether directly or indirectly such as through set-off or netting).

13.5.2. Full Return of Collateral Requirement. Notwithstanding the foregoing, the full Collateral Requirement will be returned to Seller if this Agreement is terminated in accordance with Section 11.4 or 14.10; provided that a termination under Section 11.4 only entitles Seller to a return of the full Collateral Requirement if the termination is based on a Force Majeure that prevents the Commercial Operation Date from occurring on or before the Guaranteed Commercial Date or prevents Seller from demonstrating full Contract Capacity in accordance with Appendix M.

RENEWABLE MARKET ADJUSTING TARIFF POWER PURCHASE AGREEMENT

13.5.3. Payment of Interest. Buyer shall pay simple interest on cash held to satisfy the Collateral Requirements at the rate and in the manner set forth in Section 3.7.9.

13.6. Letter of Credit.

13.6.1. If Seller has provided a Letter of Credit to satisfy the Collateral Requirement, then Seller shall renew or cause the renewal of each outstanding Letter of Credit on a timely basis as provided in the relevant Letter of Credit and in accordance with this Agreement. In the event the issuer of such Letter of Credit (a) fails to maintain a Credit Rating of at least (i) an A3 by Moody's with a stable designation and at least an A- by S&P with a stable designation, if the issuer is rated by both Moody's and S&P, or (ii) an A3 by Moody's with a stable designation or an A- by S&P with a stable designation, if the issuer is rated by either Moody's or S&P but not both, (b) indicates its intent not to renew such Letter of Credit or has not renewed such Letter of Credit at least twenty-five (25) Business Days prior to its expiration, or (c) fails to honor Buyer's properly documented request to draw on an outstanding Letter of Credit by such issuer, Seller shall cure such default by complying with either Section 13.6.1.1 or 13.6.1.2 below in an amount equal to the Collateral Requirement, and by completing the action within three (3) Business Days of the applicable event (all of which is considered the "Cure"):

13.6.1.1. providing a substitute Letter of Credit that is issued by a qualified bank acceptable to Buyer, other than the bank failing to honor the outstanding Letter of Credit, or

13.6.1.2. posting cash.

If Seller fails to Cure or if such Letter of Credit expires or terminates without a full draw thereon by Buyer, or fails or ceases to be in full force and effect at any time that such Letter of Credit is required pursuant to the terms of this Agreement, then Seller shall have failed to meet the Collateral Requirements of Section 13. If a Letter of Credit has not been renewed at least twenty (20) Business Days prior to its scheduled expiration, Buyer may draw on the Letter of Credit for the full amount of the Collateral Requirement.

13.6.2. In all cases, the costs and expenses of establishing, renewing, substituting, canceling, increasing, reducing, or otherwise administering the Letter of Credit shall be borne by Seller.

14. EVENTS OF DEFAULT AND TERMINATION

14.1. Termination. Unless terminated earlier pursuant to Section 11.4 or this Section 14, this Agreement automatically terminates immediately following the last day of the Delivery Term.

14.2. Events of Default. An “Event of Default” means, with respect to a Party, the occurrence of any of the following:

14.2.1. With respect to either Party:

14.2.1.1.A Party becomes Bankrupt;

14.2.1.2.Except for an obligation to make payment when due, if there is a failure of a Party to perform any material covenant or obligation set forth in this Agreement (except to the extent such failure provides a separate termination right for the non-breaching Party or to the extent excused by Force Majeure), if such failure is not remedied within thirty (30) days after Notice thereof from the non-breaching Party to the breaching Party;

14.2.1.3.A Party fails to make any payment due and owing under this Agreement, if such failure is not cured within five (5) Business Days after Notice from the non-breaching Party to the breaching Party; or

14.2.1.4.Any representation or warranty made by a Party (a) is false or misleading in any material respect when made or (b) becomes false or misleading in any material respect during the Term; provided that the representations and warranties made by Seller in Sections 5.3.3 or 5.3.4 shall be subject to Section 5.3.5.

14.2.2. With respect to Seller:

14.2.2.1.Seller fails to take all corrective actions specified in any Buyer Notice, within the time frame set forth in such Notice, that the Facility is out of compliance with any term of this Agreement; provided that if such corrective action falls under a specific termination right under Section 14.2.2, then the time frame, if any, set forth for such right shall apply;

14.2.2.2.The Facility has not achieved Commercial Operation by the Guaranteed Commercial Operation Date;

14.2.2.3.Subject to Section 11, Seller has not sold or delivered Product greater than 10% of the applicable Contract Quantity

RENEWABLE MARKET ADJUSTING TARIFF POWER PURCHASE AGREEMENT

from the Facility to Buyer for a period of twelve (12) consecutive months;

- 14.2.2.4. Subject to Section 4.6, Seller fails to maintain its status as an ERR as set forth in Section 4.5 of the Agreement;
- 14.2.2.5. Subject to Section 4.8, the Facility fails to maintain its status as a Qualifying Facility;
- 14.2.2.6. Seller fails to post and maintain the Collateral Requirements pursuant to Section 13 and such failure is not cured within any applicable cure period;
- 14.2.2.7. Seller abandons the Facility;
- 14.2.2.8. Seller installs generating equipment at the Facility that exceeds the Contract Capacity and such excess generating capacity is not removed within five (5) Business Days after Notice from Buyer;
- 14.2.2.9. Seller delivers or attempts to deliver to the Delivery Point for sale under this Agreement Product that was not generated by the Facility;
- 14.2.2.10. Seller fails to install any of the equipment or devices necessary for the Facility to satisfy the Contract Capacity of the Facility, as set forth in Section 13.3.1;
- 14.2.2.11. An unauthorized assignment of the Agreement, as set forth in Section 17;
- 14.2.2.12. Seller fails to reimburse Buyer any amounts due under this Agreement; or
- 14.2.2.13. Seller breaches the requirements in Section 6.15 regarding incentives.

- 14.3. Declaration of an Event of Default. If an Event of Default has occurred, the non-defaulting Party shall have the right to: (a) send Notice, designating a day, no earlier than five (5) days after such Notice and no later than twenty (20) days after such Notice, as an early termination date of this Agreement (“Early Termination Date”); (b) accelerate all amounts owing between the Parties; (c) terminate this Agreement and end the Delivery Term effective as of the Early Termination Date; (d) collect any Settlement Amount under Section 14.5; and (e) if the defaulting party is the Seller and Buyer terminates the Agreement prior to the start of the Commercial Operation



RENEWABLE MARKET ADJUSTING TARIFF POWER PURCHASE AGREEMENT

Date, Buyer shall have the right to retain (or if the Collateral Requirement has not been provided, collect) the entire Collateral Requirement.

14.4. Release of Liability for Termination.

14.4.1. Upon termination of this Agreement, neither Party shall be under any further obligation or subject to liability hereunder, except as provided in Section 3.4.2.

14.4.2. If an Event of Default shall have occurred, the non-defaulting Party has the right to immediately suspend performance under this Agreement and pursue all remedies available at Law or in equity against the defaulting Party (including monetary damages), except to the extent that such remedies are limited by the terms of this Agreement.

14.5. Calculation of Settlement Amount.

14.5.1. If either Party exercises a termination right under Section 14 after the Commercial Operation Date, the non-defaulting Party shall calculate a settlement amount ("Settlement Amount") equal to the amount of the non-defaulting Party's aggregate Losses and Costs less any Gains, determined as of the Early Termination Date. Prior to the Commercial Operation Date, the Settlement Amount shall be Zero dollars (\$0).

14.5.2. If the non-defaulting Party's aggregate Gains exceed its aggregate Losses and Costs, if any, determined as of the Early Termination Date, the Settlement Amount shall be Zero dollars (\$0).

14.5.3. The Buyer shall not have to enter into replacement transactions to establish a Settlement Amount.

14.6. Rights and Remedies Are Cumulative. The rights and remedies of the Parties pursuant to this Section 14 shall be cumulative and in addition to the rights of the Parties otherwise provided in this Agreement.

14.7. Duty to Mitigate. Buyer and Seller shall each have a duty to mitigate damages pursuant to this Agreement, and each shall use reasonable efforts to minimize any damages it may incur as a result of the other Party's non-performance of this Agreement, including with respect to termination of this Agreement.

14.8. Right of First Refusal.

14.8.1. If Seller terminates this Agreement, as provided in Sections 14.10 or 11.4 (based on a Force Majeure as to which Seller is the Claiming

RENEWABLE MARKET ADJUSTING TARIFF POWER PURCHASE AGREEMENT

Party), or if Buyer terminates this Agreement as provided in Sections 14.2.2.2 and 13.3.1, or due to an Event of Default of Seller prior to the Guaranteed Commercial Operation Date, neither Seller nor Seller's Affiliates may sell, or enter into a contract to sell, Energy, Green Attributes, Capacity Attributes, or Resource Adequacy Benefits, generated by, associated with or attributable to a generating facility installed at the Site to a party other than Buyer for a period of two (2) years following the effective date of such termination ("Restricted Period").

14.8.2. This prohibition on contracting and sale will not apply if, before entering into such contract or making a sale to a party other than Buyer, Seller or Seller's Affiliate provides Buyer with a written offer to sell the Energy, Green Attributes, Capacity Attributes and Resource Adequacy Benefits to Buyer at the Contract Price and on other terms and conditions materially similar to the terms and conditions contained in this Agreement and Buyer fails to accept such offer within forty-five (45) days after Buyer's receipt thereof.

14.8.3. Neither Seller nor Seller's Affiliates may sell or transfer the Facility, or any part thereof, or land rights or interests in the Site of the proposed Facility (including the interconnection queue position identified in Section 2.4) during the Restricted Period so long as the limitations contained in this Section 14.8 apply, unless the transferee agrees to be bound by the terms set forth in this Section 14.8 pursuant to a written agreement reasonably approved by Buyer.

14.8.4. Seller shall indemnify and hold Buyer harmless from all benefits lost and other damages sustained by Buyer as a result of any breach of the covenants contained within this Section 14.8.

14.9. Transmission Costs Termination Right.

14.9.1. Subject to Section 14.9.2, Buyer has the right to terminate this Agreement on Notice, which will be effective five (5) Business Days after such Notice is given to Seller, on or before the date that is sixty (60) days after Seller provides to Buyer the results of any Interconnection Study or the interconnection agreement tendered to Seller by the CAISO or the Transmission/Distribution Owner if:

14.9.1.1. Such study or agreement as of the date of the termination Notice estimates, includes, indicates, specifies or reflects that the maximum total cost of transmission upgrades or new transmission facilities to any Transmission/Distribution Owner, including costs reimbursed by any Transmission/Distribution Owner to Seller ("Aggregate Network Upgrade Costs"), may in

RENEWABLE MARKET ADJUSTING TARIFF POWER PURCHASE AGREEMENT

the aggregate exceed Three Hundred Thousand dollars (\$300,000.00) (“Network Upgrades Cap”), irrespective of any subsequent amendment of such study or agreement or any contingencies or assumptions upon which such study or agreement is based; or

14.9.1.2. Buyer must procure transmission service from any other Transmission/Distribution Owner to allow Buyer to Schedule Energy from the Facility and the cost of such transmission service is not reimbursed or paid by Seller.

14.9.2. Notwithstanding Section 14.9.1, Buyer shall have no right to terminate this Agreement under Section 14.9.1, if Seller (a) concurrently with its provision of the relevant Interconnection Study or interconnection agreement pursuant to Section 6.12.2, irrevocably agrees, as applicable, to pay to Buyer (i) the amount which Aggregate Network Upgrade Costs exceed the Network Upgrades Cap (“Excess Network Upgrade Costs”), such payment to be made, at Buyer’s election, either directly to the Transmission/Distribution Owner on behalf of Seller or to Buyer for transfer to the Transmission/Distribution Owner at the time due, and (ii) any costs for transmission services specified in Section 14.9.1.2, and (b) enters into an interconnection agreement that contains language requiring Seller to pay, without reimbursement from Buyer or any other Transmission/Distribution Owner, all Excess Network Upgrade Costs; provided that Buyer shall have a separate right to terminate this Agreement on Notice, which will be effective five (5) Business Days after such Notice is given to Seller, on or before the date that is ninety (90) days after FERC, CAISO, or any Transmission/Distribution Owner, as applicable, rejects Seller’s interconnection agreement, in whole or in part, or modifies Seller’s interconnection agreement, in any such case, in a manner that would make Seller unable to comply with the terms of Section 14.9.2(b). If Seller elects to pay, without reimbursement, for any Excess Network Upgrade Costs pursuant to this Section 14.9.2, in no event shall Seller have any interest in or rights or title to any Network Upgrades or Congestion Revenue Rights (as defined in the CAISO Tariff) in connection with the development of the Facility or the delivery of Product to Buyer pursuant to this Agreement.

14.10. Permit Termination Right. Either Party has the right to terminate this Agreement on Notice, which will be effective five (5) Business Days after such Notice is given, if Seller has not obtained permits necessary for the construction and operation of the Project within twenty-two (22) months after the Execution Date and a Notice of termination is given on or before the end of the twenty-third (23rd) month after the Execution Date; provided

RENEWABLE MARKET ADJUSTING TARIFF POWER PURCHASE AGREEMENT

that prior to any termination by Seller under this Section 14.10, Seller must have taken all commercially reasonable actions (including but not limited to Seller's timely filing of required documents and payment of all applicable fees) to obtain such permits.

15. **SCHEDULING COORDINATOR; FORECASTING PENALTIES; CAISO CHARGES; GOVERNMENTAL CHARGES**

- 15.1. Scheduling Coordinator. Buyer shall be Seller's designated Scheduling Coordinator (as defined by CAISO Tariff). Seller shall comply with all forecasting and outage notification requirements in Appendix D. Buyer shall be responsible for all costs and charges assessed by the CAISO with respect to Scheduling and imbalances except as provided in Sections 6.8.2, 15.2 and 15.3. Throughout the Delivery Term, Buyer shall be entitled to all CAISO revenues and credits associated with the Project.
- 15.2. Forecasting Penalties and CAISO Penalties. Seller is liable for Forecasting Penalties and CAISO Penalties under the following circumstances:
- 15.2.1. Determining Seller's Liability for Forecasting Penalties. If in any hour of any month in the Delivery Term Seller fails to comply with the requirements in Appendix D of this Agreement with respect to Seller's Available Capacity forecasting, and the sum of Energy Deviations for each of the six Settlement Intervals in that hour exceed the Performance Tolerance Band described in Section 15.2.2, then Seller is liable for a forecasting penalty ("Forecasting Penalty") equal to one hundred fifty percent (150%) of the Contract Price for each kWh of electric Energy Deviation, or any portion thereof, in that hour.
- 15.2.2. Performance Tolerance Band. The "Performance Tolerance Band," in kWh, is equal to: (a) three percent (3%) times; (b) forecasted Available Capacity times; (c) one (1) hour.
- 15.2.3. Seller's Liability for CAISO Penalties. Seller shall assume all liability and reimburse Buyer for any and all CAISO Penalties incurred by Buyer because of Seller's failure to adhere to its obligations under the CAISO Tariff or any CAISO directive or to perform any covenant or obligation set forth in this Agreement.
- 15.3. Availability Charges. If the Facility is subject to the terms of the Availability Standards, Non-Availability Charges, and Availability Incentive Payments as contemplated under Section 40.9 of the CAISO Tariff, any Availability Incentive Payments will be for the benefit of Seller and for Seller's account and any Non-Availability Charges will be the responsibility of Seller and for Seller's account.

RENEWABLE MARKET ADJUSTING TARIFF POWER PURCHASE AGREEMENT

15.4. Governmental Charges. Seller shall pay or cause to be paid all taxes imposed by any Governmental Authority (“Governmental Charges”) on or with respect to the Product or the Transaction arising at the Delivery Point, including, but not limited to, ad valorem taxes and other taxes attributable to the Project, land, land rights or interests in land for the Project. Buyer shall pay or cause to be paid all Governmental Charges on or with respect to the Product or the Transaction from the Delivery Point. In the event Seller is required by Law or regulation to remit or pay Governmental Charges which are Buyer’s responsibility hereunder, Buyer shall reimburse Seller for such Governmental Charges within thirty (30) days of Notice by Seller. If Buyer is required by Law or regulation to remit or pay Governmental Charges which are Seller’s responsibility hereunder, Buyer may deduct such amounts from payments to Seller with respect to payments under the Agreement; if Buyer elects not to deduct such amounts from Seller’s payments, Seller shall reimburse Buyer for such amounts within thirty (30) days of Notice from Buyer. Nothing shall obligate or cause a Party to pay or be liable to pay any Governmental Charges for which it is exempt under the Law. A Party that is exempt at any time and for any reason from one or more Governmental Charges bears the risk that such exemption shall be lost or the benefit of such exemption reduced; and thus, in the event a Party’s exemption is lost or reduced, each Party’s responsibility with respect to such Governmental Charge shall be in accordance with the first four sentences of this Section.

16. RELEASE OF INFORMATION AND RECORDING CONVERSATION

16.1. Release of Information. Seller authorizes Buyer to release to the FERC, CEC, the CPUC and/or other Governmental Authority information regarding the Facility, including the Seller’s name and location, and the size, location and operational characteristics of the Facility, the Term, the ERR type, the Commercial Operation Date, greenhouse gas emissions data and the net power rating of the Facility, as requested from time to time pursuant to the CEC’s, CPUC’s or applicable Governmental Authority’s rules and regulations.

16.2. Recording. Unless a Party expressly objects to a recording at the beginning of a telephone conversation, each Party consents to the creation of a tape or electronic recording of all telephone conversations between Buyer’s employees or representatives performing a Scheduling Coordinator function as provided in Section 15.1 and any representative of Seller. The Parties agree that any such recordings will be retained in confidence, secured from improper access, and may be submitted in evidence in any proceeding or action relating to this Agreement. Each Party waives any further notice of such monitoring or recording, and agrees to notify its officers and employees of such monitoring or recording and to obtain any necessary consent of such officers and employees.

RENEWABLE MARKET ADJUSTING TARIFF POWER PURCHASE AGREEMENT

17. ASSIGNMENT

- 17.1. General Assignment. Except as provided in Sections 17.2 and 17.3, neither Party shall assign this Agreement or its rights hereunder without the prior written consent of the other Party, which consent shall not be unreasonably withheld so long as among other things (a) the assignee assumes the transferring Party's payment and performance obligations under this Agreement, (b) the assignee agrees in writing to be bound by the terms and conditions hereof, (c) the transferring Party delivers evidence satisfactory to the non-transferring Party of the proposed assignee's technical and financial capability to meet or exceed such characteristics in the assigning Party's obligations hereunder and (d) the transferring Party delivers such tax and enforceability assurance as the other Party may reasonably request. Notwithstanding the foregoing and except as provided in Section 17.2, consent shall not be required for an assignment of this Agreement where the assigning Party remains subject to liability or obligation under this Agreement; provided that (i) the assignee assumes the assigning Party's payment and performance obligations under this Agreement, (ii) the assignee agrees in writing to be bound by the terms and conditions hereof, and (iii) the assigning Party provides the other Party with at least thirty (30) days' prior written Notice of the assignment. Appendix K is the General Consent to Assignment form that shall be used for this Section 17.1.
- 17.2. Assignment to Financing Providers. Seller shall be permitted to assign this Agreement as collateral for any financing or refinancing of the Project (including any tax equity or lease financing) with the prior written consent of the Buyer, which consent shall not be unreasonably withheld or delayed. The Parties agree that, the consent provided to Buyer in accordance with this Section 17.2 shall be in a form substantially similar to the Form of Financing Consent attached hereto as Appendix L; provided that (a) Buyer shall not be required to consent to any additional terms or conditions beyond those contained in Appendix L, including extension of any cure periods or additional remedies for financing providers, and (b) Seller shall be responsible at Buyer's request for Buyer's reasonable costs and attorneys' fees associated with the review, negotiation, execution and delivery of documents in connection with such assignment.
- 17.3. Notice of Change in Control. Except in connection with public market transactions of the equity interests or capital stock of Seller or Seller's Affiliates, Seller shall provide Buyer notice of any direct change of control of Seller (whether voluntary or by operation of Law).

18. GOVERNING LAW

This agreement and the rights and duties of the parties hereunder shall be governed by and construed, enforced and performed in accordance with the laws of the

RENEWABLE MARKET ADJUSTING TARIFF POWER PURCHASE AGREEMENT

state of California, without regard to principles of conflicts of law. To the extent enforceable at such time, each party waives its respective right to any jury trial with respect to any litigation arising under or in connection with this agreement. [Standard term and condition that “may not be modified” pursuant to prior Commission decisions, including Decision 07-11-025, Decision 08-08-028 and Decision 10-03-021, as modified by Decision 11-01-025]

19. DISPUTE RESOLUTION

19.1. Intent of the Parties. The sole procedure to resolve any claim arising out of or relating to this Agreement is the dispute resolution procedure set forth in this Section 19, except that either Party may seek an injunction in Superior Court in San Francisco, California if such action is necessary to prevent irreparable harm, in which case both Parties nonetheless will continue to pursue resolution of all other aspects of the dispute by means of this procedure.

19.2. Management Negotiations.

19.2.1. The Parties will attempt in good faith to resolve any controversy or claim arising out of or relating to this Agreement by prompt negotiations between each Party’s authorized representative, or such other person designated in writing as a representative of the Party (each a “Manager”). Either Manager may request a meeting to, be held in person or telephonically, to initiate negotiations to be held within ten (10) Business Days of the other Party’s receipt of such request, at a mutually agreed time and place.

19.2.2. All communication and writing exchanged between the Parties in connection with these negotiations shall be deemed confidential and shall be inadmissible as evidence such that it cannot be used or referred to in any subsequent judicial or arbitration process between the Parties, whether with respect to this dispute or any other.

19.2.3. If the matter is not resolved within forty-five (45) days of commencement of negotiations under Section 19.2.1, or if the Party receiving the written request to meet refuses or does not meet within the ten (10) Business Day period specified in Section 19.2.1, either Party may initiate arbitration of the controversy or claim according to the terms of Section 19.3.

19.3. Arbitration Initiation. If the dispute cannot be resolved by negotiation as set forth in Section 19.2 above, then the Parties shall resolve such controversy through arbitration (“Arbitration”). The Arbitration shall be adjudicated by one retired judge or justice from the JAMS panel. The Arbitration shall take place in San Francisco, California, and shall be administered by and in accordance with JAMS’ Commercial Arbitration Rules. If the Parties cannot



RENEWABLE MARKET ADJUSTING TARIFF POWER PURCHASE AGREEMENT

mutually agree on the arbitrator who will adjudicate the dispute, then JAMS shall provide the Parties with an arbitrator pursuant to its then-applicable Commercial Arbitration Rules. The arbitrator shall have no affiliation with, financial or other interest in, or prior employment with either Party and shall be knowledgeable in the field of the dispute. Either Party may initiate Arbitration by filing with the JAMS a notice of intent to arbitrate at any time following the unsuccessful conclusion of the management negotiations provided for in Section 19.2.

19.4. Arbitration Process. The arbitrator shall have the discretion to order depositions of witnesses to the extent the arbitrator deems such discovery relevant and appropriate. Depositions shall be limited to a maximum of three (3) per Party and shall be held within thirty (30) days of the making of a request for depositions. Additional depositions may be scheduled only with the permission of the arbitrator, and for good cause shown. Each deposition shall be limited to a maximum of six (6) hours duration unless otherwise permitted by the arbitrator for good cause shown. All objections are reserved for the Arbitration hearing except for objections based on privilege and proprietary and confidential information. The arbitrator shall also have discretion to order the Parties to exchange relevant documents. The arbitrator shall also have discretion to order the Parties to answer interrogatories, upon good cause shown.

19.4.1. Each of the Parties shall submit to the arbitrator, in accordance with a schedule set by the arbitrator, offers in the form of the award it considers the arbitrator should make. If the arbitrator requires the Parties to submit more than one such offer, the arbitrator shall designate a deadline by which time the Parties shall submit their last and best offer. In such proceedings the arbitrator shall be limited to awarding only one of the two "last and best" offers submitted, and shall not determine an alternative or compromise remedy.

19.4.2. The arbitrator shall have no authority to award punitive or exemplary damages or any other damages other than direct and actual damages and the other remedies contemplated by this Agreement.

19.4.3. The arbitrator's award shall be made within nine (9) months of the notice of intention to arbitrate and the arbitrator shall agree to comply with this schedule before accepting appointment. However, this time limit may be extended by agreement of the Parties or by the arbitrator, if necessary. At the conclusion of the Arbitration, the arbitrator shall prepare in writing and provide to each Party a decision setting forth factual findings, legal analysis, and the reasons on which the arbitrator's decision is based.



RENEWABLE MARKET ADJUSTING TARIFF POWER PURCHASE AGREEMENT

- 19.4.4. The arbitrator shall not have the power to commit errors of law or fact, or to commit any abuse of discretion, that would constitute reversible error had the decision been rendered by a California superior court. The arbitrator's decision may be vacated or corrected on appeal to a California court of competent jurisdiction for such error.
- 19.4.5. The California Superior Court of the City and County of San Francisco may enter judgment upon any award rendered by the arbitrator. The Parties are aware of the decision in *Advanced Micro Devices, Inc. v. Intel Corp.*, 9 Cal. 4th 362 (1994) and, except as modified by this Agreement, intend to limit the power of the arbitrator to that of a Superior Court judge enforcing California Law.
- 19.4.6. The prevailing Party in this dispute resolution process is entitled to recover its costs and reasonable attorneys' fees.
- 19.4.7. The arbitrator shall have the authority to grant dispositive motions prior to the commencement of or following the completion of discovery if the arbitrator concludes that there is no material issue of fact pending before him or her.
- 19.4.8. Unless otherwise agreed to by the Parties, all proceedings before the arbitrator shall be reported and transcribed by a certified court reporter, with each Party bearing one-half of the court reporter's fees.
- 19.4.9. Except as may be required by Law, neither a Party nor an arbitrator may disclose the existence, content, or results of any Arbitration hereunder without the prior written consent of both Parties.

20. MISCELLANEOUS

- 20.1. Severability. If any provision in this Agreement is determined to be invalid, void or unenforceable by the CPUC or any court having jurisdiction, such determination shall not invalidate, void, or make unenforceable any other provision, agreement or covenant of this Agreement. Any provision of this Agreement held invalid or unenforceable only in part or degree will remain in full force and effect to the extent not held invalid or unenforceable.
- 20.2. Counterparts. This Agreement may be executed in one or more counterparts each of which shall be deemed an original and all of which shall be deemed one and the same Agreement. Delivery of an executed counterpart of this Agreement by facsimile or PDF transmission will be deemed as effective as delivery of an originally executed counterpart. Each Party delivering an executed counterpart of this Agreement by facsimile or PDF transmission will also deliver an originally executed counterpart, but



RENEWABLE MARKET ADJUSTING TARIFF POWER PURCHASE AGREEMENT

the failure of any Party to deliver an originally executed counterpart of this Agreement will not affect the validity or effectiveness of this Agreement.

- 20.3. General. This Agreement has been approved by the CPUC and modification of the terms and conditions of this Agreement, other than administrative amendments that do not impact the CPUC approved standard terms and conditions of this Agreement, will result in the need to obtain additional CPUC approval of the amended Agreement. In addition to the foregoing, no amendment to or modification of this Agreement shall be enforceable unless reduced to writing and executed by both Parties. This Agreement shall not impart any rights enforceable by any third party other than a permitted successor or assignee bound to this Agreement. Waiver by a Party of any default by the other Party shall not be construed as a waiver of any other default. The term “including” when used in this Agreement shall be by way of example only and shall not be considered in any way to be in limitation. The headings used herein are for convenience and reference purposes only.
- 20.4. Interpretation. Whenever this Agreement specifically refers to any Law, tariff, Governmental Authority, regional reliability council, Transmission/Distribution Owner, or credit rating agency, the Parties hereby agree that the references also refers to any successor to such Law, tariff or organization.
- 20.5. Construction. The Parties acknowledge and agree that this Agreement has been approved by the CPUC and that the Agreement will not be construed against any Party as a result of the preparation, substitution, or other event of negotiation, drafting or execution thereof.



RENEWABLE MARKET ADJUSTING TARIFF
POWER PURCHASE AGREEMENT

IN WITNESS WHEREOF, each Party has caused this Agreement to be duly executed by its authorized representative as of the date of last signature provided below.

PUTAH CREEK SOLAR FARMS, LLC

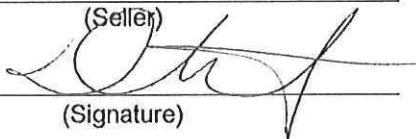
 (Seller)

 (Signature)
 Daniel R Martinez

 (Type/Print Name)
 CFO

 (Title)
 12/16/2013

 (Date)

PACIFIC GAS AND ELECTRIC COMPANY

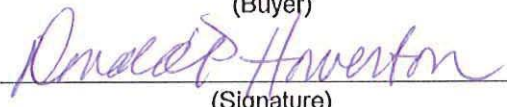
 (Buyer)

 (Signature)
 Donald P. Haverton

 (Type/Print Name)
 Director - Renewable Transactions

 (Title)
 12/20/13

 (Date)

Appendix A - Definitions

“Accepted Compliance Costs” has the meaning set forth in Section 4.6.3.

“Affiliate” means, with respect to a Party, any entity that, directly or indirectly, through one or more intermediaries, controls, or is controlled by, or is under common control with that Party.

“Aggregate Network Upgrade Costs” has the meaning set forth in Section 14.9.1.1.

“Aggregated Telemetry Cost Cap” has the meaning set forth in Appendix F.
[Only applicable if Facility is less than 500 kW]

“Aggregated Telemetry System” has the meaning set forth in Appendix F.
[Only applicable if Facility is less than 500 kW]

“Aggregated Telemetry System Installation Costs” means initial costs to Seller for the purchase and installation of the Aggregated Telemetry System. In no event shall “Aggregated Telemetry System Installation Costs” include ongoing operating expenses of the Aggregated Telemetry System following its initial installation, including but not limited to communication costs and costs associated with maintaining a T-1 line. *[Only applicable if Facility is less than 500 kW]*

“Arbitration has the meaning set forth in Section 19.3.

“As-Available Facility” means a generating facility that is powered by one of the following sources, except for a de minimis amount of Energy from other sources: (a) wind, (b) solar energy, (c) hydroelectric potential derived from small conduit water distribution facilities that do not have storage capability, or (d) other variable sources of energy that are contingent upon natural forces other than geothermal.

“Available Capacity” means the power output from the Facility, expressed in whole kilowatts, that is available to generate Product.

“Availability Standards” means the program set forth in Section 40.9 of the CAISO Tariff, as it may be amended, supplemented or replaced (in whole or in part) from time to time, setting forth certain standards regarding the desired level of availability for Resource Adequacy resources and possible charges and incentive payments for performance thereunder.

“Bankrupt” means with respect to any entity, such entity:

(a) Files a petition or otherwise commences, authorizes or acquiesces in the commencement of a proceeding or cause of action under any bankruptcy, insolvency, reorganization or similar law, or has any such petition filed or commenced against it;

APPENDIX A - DEFINITIONS

- (b) Makes an assignment or any general arrangement for the benefit of creditors;
- (c) Otherwise becomes bankrupt or insolvent (however evidenced);
- (d) Has a liquidator, administrator, receiver, trustee, conservator or similar official appointed with respect to such entity or any substantial portion of its property or assets; or
- (e) Is generally unable to pay its debts as they fall due.

“Baseload Facility” means a generating facility that does not qualify as an As-Available Facility.

“Business Day” means any day except a Saturday, Sunday, a Federal Reserve Bank holiday, or the Friday following Thanksgiving during the hours of 8:00 a.m. and 5:00 p.m. local time for the relevant Party’s principal place of business where the relevant Party in each instance shall be the Party from whom the notice, payment or delivery is being sent.

“Buyer’s WREGIS Account” has the meaning set forth in Section 4.3.1. *[for Facilities (1) 500 kW or greater and (2) eligible for a CAISO revenue meter.]*

“CAISO” means the California Independent System Operator Corporation or any successor entity performing similar functions.

“CAISO Grid” means the system of transmission lines and associated facilities that have been placed under the CAISO’s operational control.

“CAISO Penalties” means any fees, liabilities, assessments, or similar charges assessed by the CAISO for (a) violation of the CAISO Tariff and all applicable protocols, WECC rules or CAISO operating instructions or orders or (b) as a result of Seller’s failure to follow Prudent Electrical Practices. “CAISO Penalties” do not include the costs and charges related to Scheduling and imbalances as addressed in Section 15.1 of this Agreement.

“CAISO Tariff” means the CAISO FERC Electric Tariff, Fifth Replacement Volume No. 1, as amended from time to time.

“California Renewables Portfolio Standard” means the renewable energy program and policies codified in California Public Utilities Code Sections 399.11 through 399.31 and California Public Resources Code Sections 25740 through 25751, as such provisions may be amended or supplemented from time to time.

“Capacity Attributes” means any current or future defined characteristic, certificate, tag, credit, or ancillary service attribute, whether general in nature or specific

APPENDIX A - DEFINITIONS

as to the location or any other attribute of the Project, intended to value any aspect of the capacity of the Project to produce Energy or ancillary services, including, but not limited to, any accounting construct so that the full Contract Capacity of the Project may be counted toward a Resource Adequacy Requirement or any other measure by the CPUC, the CAISO, the FERC, or any other entity invested with the authority under federal or state Law, to require Buyer to procure, or to procure at Buyer's expense, Resource Adequacy or other such products.

"CEC" means the California Energy Commission or its successor agency.

"CEC Certification" means certification by the CEC that the Facility is an ERR and that all Energy produced by the Facility qualifies as generation from an ERR.

"CEC Pre-Certification" means provisional certification of the proposed Facility as an ERR by the CEC upon submission by a facility of a complete CEC-RPS-1B application and required supplemental information.

"CEC Verification" means verification by the CEC based on ongoing reporting by Seller that the Facility is an ERR and that all Energy produced by the Facility qualifies as generation from an ERR.

"Check Meter" means the Buyer revenue-quality meter section(s) or meter(s), which Buyer may require at its discretion, and which will include those devices normally supplied by Buyer or Seller under the applicable utility electric service requirements.

"Claiming Party" has the meaning set forth in Section 11.2.

"Collateral Requirement" has the meaning set forth in Section 13.1.

"Commercial Operation" means the Facility is operating and able to produce and deliver the Product to Buyer pursuant to the terms of this Agreement.

"Commercial Operation Date" means the date on which the Facility achieves Commercial Operation.

"Compliance Action" has the meaning set forth in Section 4.6.1.

"Compliance Expenditure Cap" has the meaning set forth in Section 4.6.

"Contract Capacity" means the lesser of: (a) the amount of electric energy generating capacity, set forth in Section 3.1, that Seller commits to install at the Site; and (b) the Demonstrated Contract Capacity.

"Contract Price" has the meaning set forth in Section 3.6.

"Contract Quantity" has the meaning set forth in Section 3.2.

RENEWABLE MARKET ADJUSTING TARIFF POWER PURCHASE AGREEMENT

APPENDIX A - DEFINITIONS

“Contract Year” means a period of twelve (12) consecutive months with the first Contract Year commencing on the Commercial Operation Date and each subsequent Contract Year commencing on the anniversary of the Commercial Operation Date.

“Control Area” means the electric power system (or combination of electric power systems) under the operational control of the CAISO or any other electric power system under the operation control of another organization vested with authority comparable to that of the CAISO.

“Costs” means (a) brokerage fees, commissions and other similar third-party transaction costs and expenses reasonably incurred either in terminating any arrangement pursuant to which it has hedged its obligations or in entering into new arrangements which replace the Transaction; and (b) all reasonable attorneys’ fees and expenses incurred in connection with the termination of the Transaction.

“CPUC” means the California Public Utilities Commission, or successor entity.

“Credit Rating” means, with respect to any entity, (a) the rating then assigned to such entity’s unsecured senior long-term debt obligations (not supported by third party credit enhancements), or (b) if such entity does not have a rating for its unsecured senior long-term debt obligations, then the rating assigned to such entity as an issuer rating by S&P and/or Moody’s. If the entity is rated by both S&P and Moody’s and such ratings are not equivalent, the lower of the two ratings shall determine the Credit Rating. If the entity is rated by either S&P or Moody’s, but not both, then the available rating shall determine the Credit Rating.

“Cure” has the meaning set forth in Section 13.6.

“Current Inverters” means devices used to convert DC electric energy to alternating current electric energy. [*for solar photovoltaic technology*]

“Curtailed Product Payment” means the sum of all payments each month for Paid Curtailed Product.

“Curtailment Order” means any instruction from Buyer to Seller to reduce the delivery of Energy from the Facility for any reason other than as set forth in Sections 6.8.1(a) or (b).

“Daily Delay Liquidated Damages” has the meaning set forth in Section 2.8.2.4.

“DC” means direct current. [*for solar photovoltaic technology*]

“DC Collection System” means the DC equipment, cables, components, devices and materials that interconnect the Photovoltaic Modules with the Current Inverters. [*for solar photovoltaic technology*]

APPENDIX A - DEFINITIONS

“Deficient Month” has the meaning set forth in Section 4.3.5. *[for Facilities (1) 500 kW or greater and (2) eligible for a CAISO revenue meter.]*

“Delay” has the meaning set forth in Section 2.9.1.

“Deliverability Upgrades” means all Network Upgrades necessary for the Facility to receive Full Capacity Deliverability Status.

“Delivered Energy” means all Energy produced from the Project, expressed in kWh, as recorded by the meter specified in Section 6.2.1 or the Check Meter, as applicable.

“Delivery Point” means the point of interconnection to the CAISO Grid and, for payment purposes, the corresponding PNode.

“Delivery Term” has the meaning set forth in Section 3.5.

“Demonstrated Contract Capacity” means the Facility’s total rated electric alternating current energy generating capacity which will equal the [lesser of (a) the sum of the Inverter Block Unit Capacity of all Inverter Block Units in the Facility and (b) the continuous output power rating at the expected operating power factor of the step-up transformer that connects the Facility to the Transmission/Distribution Owner’s system*[for solar photovoltaic technology]* [the total of the manufacturer’s nameplate ratings of all installed Wind Turbines, consistent with Prudent Electrical Practices and accepted industry standards, as indicated on the nameplates physically attached to the individual Wind Turbine generators*[for wind technology]*] [sum of the Metered Amounts for the Demonstration Hour*[all other technologies]*], as determined in accordance with Appendix M.

“Demonstration Date” has the meaning set forth in Appendix M. *[for solar photovoltaic and wind technologies]*

“Demonstration Hour” has the meaning set forth in Appendix M. *[for technologies other than solar photovoltaic and wind]*

“Distribution Upgrades” has the meaning set forth in the CAISO Tariff.

“Early Termination Date” has the meaning set forth in Section 14.3.

“Electric System Upgrades” means any Network Upgrades, Distribution Upgrades, Deliverability Upgrades, or Interconnection Facilities that are determined to be necessary by the CAISO or Transmission/Distribution Owner, as applicable, to physically and electrically interconnect the Project to the Transmission/Distribution Owner’s electric system for receipt of Energy at the Point of Interconnection (as defined in the CAISO Tariff) if connecting to the CAISO Grid, or the Interconnection Point, if the Transmission/Distribution Owner’s electric system is not part of the CAISO Grid.

APPENDIX A - DEFINITIONS

“Eligible Intermittent Resources Protocol” or “EIRP” has the meaning set forth in the CAISO Tariff.

“Eligible Renewable Energy Resource” or “ERR” has the meaning set forth in Public Utilities Code Sections 399.12 and California Public Resources Code Section 25741, as either code provision may be amended or supplemented from time to time.

“Emergency” means (a) an actual or imminent condition or situation which jeopardizes the integrity of the electric system or the integrity of any other systems to which the electric system is connected or any condition so defined and declared by the CAISO; or (b) an emergency condition as defined under an interconnection agreement and any abnormal interconnection or system condition that requires automatic or immediate manual action to prevent or limit loss of load or generation supply, that could adversely affect the reliability of the electric system or generation supply, that could adversely affect the reliability of any interconnected system, or that could otherwise pose a threat to public safety.

“Energy” means three-phase, 60-cycle alternating current electric energy measured in kWh, net of Station Use and, in the case of excess sales arrangements, any Site Host Load. For purposes of the definition of “Green Attributes,” the word “energy” shall have the meaning set forth in this definition.

“Energy Deviation(s)” means the absolute value of the difference, in kWh, in any Settlement Interval between (a) the final accepted Bid (as defined in the CAISO Tariff) submitted for the Project for the hour of the Settlement Interval divided by the number of Settlement Intervals in the hour; and (b) Delivered Energy for the Settlement Interval.

“Engineer Report” has the meaning set forth in Appendix M.

“Excess Network Upgrade Costs” has the meaning set forth in Section 14.9.2.

“Execution Date” means the latest signature date found at the end of the Agreement.

“Facility” has the meaning set forth in Section 2. The terms “Facility” or “Project” as used in this Agreement are interchangeable.

“FERC” means the Federal Energy Regulatory Commission or any successor government agency.

“Forced Outage” means any unplanned reduction or suspension of the electrical output from the Facility resulting in the unavailability of the Facility, in whole or in part, in response to a mechanical, electrical, or hydraulic control system trip or operator-initiated trip in response to an alarm or equipment malfunction and any other unavailability of the Facility for operation, in whole or in part, for maintenance or repair that is not a scheduled maintenance outage and not the result of Force Majeure.

APPENDIX A - DEFINITIONS

“Force Majeure” means any occurrence that was not anticipated as of the Execution Date that:

- (a) In whole or in part:
 - (i) Delays a Party’s performance under this Agreement;
 - (ii) Causes a Party to be unable to perform its obligations; or
 - (iii) Prevents a Party from complying with or satisfying the conditions of this Agreement;
- (b) Is not within the control of that Party; and
- (c) The Party has been unable to overcome by the exercise of due diligence, including an act of God, flood, drought, earthquake, storm, fire, pestilence, lightning and other natural catastrophes, epidemic, war, riot, civil disturbance or disobedience, terrorism, sabotage, strike or labor dispute, or curtailment or reduction in deliveries at the direction of a Transmission/Distribution Owner or the CAISO (except as set forth below).

Force Majeure does not include:

- (d) The lack of wind, sun or other fuel source of an inherently intermittent nature;
- (e) Reductions in generation from the Facility resulting from ordinary wear and tear, deferred maintenance or operator error;
- (f) Curtailment or reduction in deliveries at the direction of a Transmission/Distribution Owner or the CAISO when the basis of the curtailment or reduction in deliveries ordered by a Transmission/Distribution Owner or the CAISO is congestion arising in the ordinary course of operations of the Transmission/Distribution Owner’s system or the CAISO Grid, including congestion caused by outages or capacity reductions for maintenance, construction or repair; or
- (g) Any delay in providing, or cancellation of, interconnection service by a Transmission/Distribution Owner or the CAISO, except to the extent such delay or cancellation is the result of a force majeure claimed by the Transmission/Distribution Owner or the CAISO.

“Force Majeure Delay” has the meaning set forth in Section 2.8.2.3

“Forecasting Penalty” has the meaning set forth in Section 15.2.1.

APPENDIX A - DEFINITIONS

“Full Capacity Deliverability Status” has the meaning set forth in the CAISO Tariff.

“Full Capacity Option Notice” has the meaning set forth in Section 4.4.3.

“Gains” means with respect to any Party, an amount equal to the present value of the economic benefit to it, if any (exclusive of Costs), resulting from the termination of the Transaction, determined in a commercially reasonable manner, subject to Section 14.5. Factors used in determining economic benefit may include, without limitation, reference to information either available to it internally or supplied by one or more third parties, including, without limitation, quotations (either firm or indicative) of relevant rates, prices, yields, yield curves, volatilities, spreads or other relevant market data in the relevant markets, market price referent, market prices for a comparable transaction, forward price curves based on economic analysis of the relevant markets, settlement prices for a comparable transaction at liquid trading platforms (e.g., NYMEX), all of which should be calculated for the remaining Delivery Term to determine the value of the Product.

“GEP Damages” has the meaning set forth in Appendix G.

“GEP Failure” means Seller’s failure to produce Delivered Energy in an amount equal to or greater than the Guaranteed Energy Production amount for the applicable Performance Measurement Period.

“GEP Shortfall” means the amount in MWh by which Seller failed to achieve the Guaranteed Energy Production in the applicable Performance Measurement Period.

“Governmental Authority” means any federal, state, local or municipal government, governmental department, commission, board, bureau, agency, or instrumentality, or any judicial, regulatory or administrative body, having jurisdiction as to the matter in question.

“Governmental Charges” has the meaning set forth in Section 15.4.

“Green Attributes” means any and all credits, benefits, emissions reductions, offsets, and allowances, howsoever entitled, attributable to the generation from the Project, and its avoided emission of pollutants. Green Attributes include but are not limited to Renewable Energy Credits, as well as: (1) any avoided emission of pollutants to the air, soil or water such as sulfur oxides (SOx), nitrogen oxides (NOx), carbon monoxide (CO) and other pollutants; (2) any avoided emissions of carbon dioxide (CO₂), methane (CH₄), nitrous oxide, hydrofluorocarbons, perfluorocarbons, sulfur hexafluoride and other greenhouse gases (GHGs) that have been determined by the United Nations Intergovernmental Panel on Climate Change, or otherwise by law, to contribute to the actual or potential threat of altering the Earth’s climate by trapping heat

APPENDIX A - DEFINITIONS

in the atmosphere¹; (3) the reporting rights to these avoided emissions, such as Green Tag Reporting Rights. Green Tag Reporting Rights are the right of a Green Tag Purchaser to report the ownership of accumulated Green Tags in compliance with federal or state law, if applicable, and to a federal or state agency or any other party at the Green Tag Purchaser's discretion, and include without limitation those Green Tag Reporting Rights accruing under Section 1605(b) of The Energy Policy Act of 1992 and any present or future federal, state, or local law, regulation or bill, and international or foreign emissions trading program. Green Tags are accumulated on a MWh basis and one Green Tag represents the Green Attributes associated with one (1) MWh of Energy. Green Attributes do not include (i) any energy, capacity, reliability or other power attributes from the Project, (ii) production tax credits associated with the construction or operation of the Project and other financial incentives in the form of credits, reductions, or allowances associated with the project that are applicable to a state or federal income taxation obligation, (iii) fuel-related subsidies or "tipping fees" that may be paid to Seller to accept certain fuels, or local subsidies received by the generator for the destruction of particular preexisting pollutants or the promotion of local environmental benefits, or (iv) emission reduction credits encumbered or used by the Project for compliance with local, state, or federal operating and/or air quality permits. If the Project is a biomass or biogas facility and Seller receives any tradable Green Attributes based on the greenhouse gas reduction benefits or other emission offsets attributed to its fuel usage, it shall provide Buyer with sufficient Green Attributes to ensure that there are zero net emissions associated with the production of electricity from the Project. [Standard term and condition that "may not be modified" pursuant to prior Commission decisions, including Decision 07-11-025, Decision 08-08-028 and Decision 10-03-021, as modified by Decision 11-01-025]

"Guaranteed Commercial Operation Date" has the meaning set forth in Section 2.8.2.

"Guaranteed Energy Production" or "GEP" has the meaning set forth in Section 12.2.

"Installed DC Rating" means, at any time, the sum of the Photovoltaic Module DC Ratings for all Photovoltaic Modules actually installed at the Site and verified by Buyer in accordance with Appendix M, or at Buyer's option, in an Engineer Report, expressed in kWDC. *[for solar photovoltaic technology]*

"Interconnection Facilities" has the meaning set forth in the tariff applicable to the Seller's interconnection agreement.

¹ Avoided emissions may or may not have any value for GHG compliance purposes. Although avoided emissions are included in the list of Green Attributes, this inclusion does not create any right to use those avoided emissions to comply with any GHG regulatory program.

APPENDIX A - DEFINITIONS

“Interconnection Study” means any of the studies defined in the CAISO’s Tariff or any Transmission/Distribution Owner’s tariff that reflect methodology and costs to interconnect the Facility to the Transmission/Distribution Owner’s electric grid.

“Interest Rate” means the rate per annum equal to the “Monthly” Federal Funds Rate (as reset on a monthly basis based on the latest month for which such rate is available) as reported in Federal Reserve Bank Publication H.15-519, or its successor publication.

“Inverter Block Unit” means each Current Inverter installed on the Site as part of the Facility, along with the associated DC Collection Systems and Photovoltaic Modules connected to such Current Inverter. *[for solar photovoltaic technology]*

“Inverter Block Unit Capacity” means, with respect to each Inverter Block Unit, the total rated electric alternating current energy generating capacity of such Inverter Block Unit, determined as the lesser of:

(a) The manufacturer’s output rating of the Current Inverter included in such Inverter Block Unit, consistent with Prudent Electrical Practices and accepted industry standards, as indicated on the nameplate physically attached to such Current Inverter;

(b) The sum of the manufacturer’s nameplate ratings of all Photovoltaic Modules included in such Inverter Block Unit, consistent with Prudent Electrical Practices and accepted industry standards, as indicated on the nameplates physically attached to such individual Photovoltaic Modules; and

(c) The continuous power output rating at the expected operating power factor of the Inverter Block Unit’s medium voltage transformer.
[for solar photovoltaic technology]

“JAMS” means JAMS, Inc. or its successor entity, a judicial arbitration and mediation service.

“kW” means kilowatt.

“kWh” means kilowatt-hour.

“kWPC” means peak DC power. *[for solar photovoltaic technology]*

“Law” means any statute, law, treaty, rule, regulation, ordinance, code, permit, enactment, injunction, order, writ, decision, authorization, judgment, decree or other legal or regulatory determination or restriction by a court or Governmental Authority of competent jurisdiction, including any of the foregoing that are enacted, amended, or issued after the Execution Date, and which becomes effective during the Delivery Term; or any binding interpretation of the foregoing.

APPENDIX A - DEFINITIONS

“Letter(s) of Credit” means an irrevocable, non-transferable standby letter of credit issued either by (a) a U.S. commercial bank, or (b) a U.S. branch of a foreign commercial bank, acceptable to Buyer, with either such bank having a Credit Rating of at least: (i) an A- from S&P with a stable designation and an A3 from Moody’s with a stable designation, if such bank is rated by both S&P and Moody’s; or (ii) an A- from S&P with a stable designation or an A3 from Moody’s with a stable designation, if such bank is rated by either S&P or Moody’s, but not both, even if such bank was rated by both S&P and Moody’s as of the date of issuance of the Letter of Credit but ceases to be rated by either, but not both of those ratings agencies. The Letter of Credit must be substantially in the form as contained in Appendix H to this Agreement; provided that if the Letter of Credit is issued by a branch of a foreign bank, Buyer may require changes to such form.

“Licensed Professional Engineer” means a person acceptable to Buyer in its reasonable judgment who (a) is licensed to practice engineering in California, (b) has training and experience in the power industry specific to the technology of the Project, (c) has no economic relationship, association, or nexus with Seller or Buyer, other than to meet the obligations of Seller pursuant to this Agreement, (d) is not a representative of a consultant, engineer, contractor, designer or other individual involved in the development of the Project or of a manufacturer or supplier of any equipment installed at the Project, and (e) is licensed in an appropriate engineering discipline for the required certification being made.

“Losses” means, with respect to any Party, an amount equal to the present value of the economic loss to it, if any (exclusive of Costs), resulting from the termination of the Transaction, determined in a commercially reasonable manner, subject to Section 14.5. Factors used in determining the loss of economic benefit may include, without limitation, reference to information either available to it internally or supplied by one or more third parties including, without limitation, quotations (either firm or indicative) of relevant rates, prices, yields, yield curves, volatilities, spreads or other relevant market data in the relevant markets, market price referent, market prices for a comparable transaction, forward price curves based on economic analysis of the relevant markets, settlement prices for a comparable transaction at liquid trading platforms (e.g. NYMEX), all of which should be calculated for the remaining term of the Transaction to determine the value of the Product.

“Manager” has the meaning set forth in Section 19.2.

“Meter Service Agreement” has the meaning set forth in the CAISO Tariff.

“MW” means megawatt (AC).

“MWh” means megawatt-hour.

“Network Upgrades” has the meaning set forth in the CAISO Tariff.

APPENDIX A - DEFINITIONS

“Network Upgrades Cap” has the meaning set forth in Section 14.9.1.1.

“Notice,” unless otherwise specified in the Agreement, means written communications by a Party to be delivered by hand delivery, United States mail, overnight courier service, facsimile or electronic messaging (e-mail).

“Paid Curtailed Product” has the meaning set forth in Section 6.8.3. The amount of “Paid Curtailed Product” shall be determined as set forth in Section 6.8.4.

“Participating Generator Agreement” has the meaning set forth in the CAISO Tariff.

“Participating Intermittent Resource” or “PIRP” has the meaning set forth in the CAISO Tariff.

“Party” means the Buyer or Seller individually, and “Parties” means both collectively. For purposes of Section 18 (Governing Law) the word “party” or “parties” shall have the meaning set forth in this definition.

“Payment Allocation Factors” shall initially mean the energy-only payment allocation factors set forth in Appendix C. Effective with respect to payments for periods beginning on or after the first day of the calendar month following receipt of a valid Full Capacity Option Notice, “Payment Allocation Factors” shall mean, with respect to such periods, the full capacity deliverability payment allocation factors set forth in Appendix C.

“Performance Measurement Period” has the meaning set forth in Section 12.1.

“Performance Tolerance Band” shall be calculated as set forth in Section 15.2.2.

“Permitting Delay” has the meaning set forth in Section 2.8.2.1.

“Permitted Extensions” has the meaning set forth in Section 2.8.2.

“Photovoltaic Module” means the individual module or component that produces DC electric energy from sun light. *[for solar photovoltaic technology]*

“Photovoltaic Module DC Rating” means, for each Photovoltaic Module installed or to be installed at the Site, the number (expressed in kWpDC) stated on the nameplate affixed thereto representing the manufacturer’s maximum (at “peak” sunlight) DC power rating at the standard test condition (“Pmp” or Power maximum at peak). *[for solar photovoltaic technology]*

“Planned Outage” means the removal of equipment from service availability for inspection and/or general overhaul of one or more major equipment groups. To qualify as a Planned Outage, the maintenance (a) must actually be conducted during the

APPENDIX A - DEFINITIONS

Planned Outage, and in Seller's sole discretion must be of the type that is necessary to reliably maintain the Project, (b) cannot be reasonably conducted during Project operations, and (c) causes the generation level of the Project to be reduced by at least ten percent (10%) of the Contract Capacity.

"PNode" has the meaning set forth in the CAISO Tariff.

"Product" means all electric energy produced by the Facility throughout the Delivery Term, net of Station Use, electrical losses from the Facility to the Delivery Point, and, in the case of excess sale arrangements, any Site Host Load; all Green Attributes; all Capacity Attributes, if any; and all Resource Adequacy Benefits, if any; generated by, associated with or attributable to the Facility throughout the Delivery Term.

"Project" has the meaning set forth in Section 2. The terms "Facility" and "Project" as used in this Agreement are interchangeable.

"Prudent Electrical Practices" means those practices, methods and acts that would be implemented and followed by prudent operators of electric energy generating facilities in the Western United States, similar to the Facility, during the relevant time period, which practices, methods and acts, in the exercise of prudent and responsible professional judgment in the light of the facts known at the time the decision was made, could reasonably have been expected to accomplish the desired result consistent with good business practices, reliability and safety. Prudent Electrical Practices shall include, at a minimum, those professionally responsible practices, methods and acts described in the preceding sentence that comply with manufacturers' warranties, restrictions in this Agreement, and the requirements of Governmental Authorities, WECC standards, the CAISO and Laws. Prudent Electrical Practices also includes taking reasonable steps to ensure that:

(a) Equipment, materials, resources, and supplies, including spare parts inventories, are available to meet the Facility's needs;

(b) Sufficient operating personnel are available at all times and are adequately experienced and trained and licensed as necessary to operate the Facility properly and efficiently, and are capable of responding to reasonably foreseeable emergency conditions at the Facility and Emergencies whether caused by events on or off the Site;

(c) Preventive, routine, and non-routine maintenance and repairs are performed on a basis that ensures reliable, long term and safe operation of the Facility, and are performed by knowledgeable, trained, and experienced personnel utilizing proper equipment and tools;

APPENDIX A - DEFINITIONS

(d) Appropriate monitoring and testing are performed to ensure equipment is functioning as designed;

(e) Equipment is not operated in a reckless manner, in violation of manufacturer's guidelines or in a manner unsafe to workers, the general public, or the Transmission/Distribution Owner's electric system or contrary to environmental laws, permits or regulations or without regard to defined limitations such as, flood conditions, safety inspection requirements, operating voltage, current, volt ampere reactive (VAR) loading, frequency, rotational speed, polarity, synchronization, and control system limits; and

(f) Equipment and components are designed and manufactured to meet or exceed the standard of durability that is generally used for electric energy generating facilities operating in the Western United States and will function properly over the full range of ambient temperature and weather conditions reasonably expected to occur at the Site and under both normal and emergency conditions.

"PURPA" means the Public Utility Regulatory Policies Act of 1978, Public Law, 95-617, as amended from time to time.

"Qualifying Facility" means an electric energy generating facility that complies with the qualifying facility definition established by PURPA and any FERC rules as amended from time to time (18 Code of Federal Regulations Part 292, Section 292.203 et seq.) implementing PURPA and, to the extent required to obtain or maintain Qualifying Facility status, is self-certified as a Qualifying Facility or is certified as a Qualified Facility by the FERC.

"Renewable Energy Credit" has the meaning set forth in Public Utilities Code Section 399.12(h), as may be amended from time to time or as further defined or supplemented by Law.

"Resource Adequacy" means the procurement obligation of load serving entities, including Buyer, as such obligations are described in CPUC Decisions D.04-10-035 and D.05-10-042 and subsequent CPUC decisions addressing Resource Adequacy issues, as those obligations may be altered from time to time in the CPUC Resource Adequacy Rulemakings (R.) 04-04-003 and (R.) 05-12-013 or by any successor proceeding, and all other Resource Adequacy obligations established by any other entity, including the CAISO.

"Resource Adequacy Benefits" means the rights and privileges attached to the Facility that satisfy any entity's resource adequacy obligations, as those obligations are set forth in any Resource Adequacy Rulings and shall include any local, zonal or otherwise locational attributes associated with the Facility.

"Resource Adequacy Requirements" has the meaning set forth in Section 4.4.1.

RENEWABLE MARKET ADJUSTING TARIFF POWER PURCHASE AGREEMENT

APPENDIX A - DEFINITIONS

“Resource Adequacy Rulings” means CPUC Decisions 04-01-050, 04-10-035, 05-10-042, 06-06-064, 06-07-031, 07-06-029, 08-06-031, 09-06-028, 10-06-036, 11-06-022 and any subsequent CPUC ruling or decision, or any other resource adequacy laws, rules or regulations enacted, adopted or promulgated by any applicable Governmental Authority, as such decisions, rulings, Laws, rules or regulations may be amended or modified from time-to-time during the Delivery Term.

“Restricted Period” has the meaning set forth in Section 14.8.1.

“Schedule,” “Scheduled” or “Scheduling” means the action of Buyer in submitting bids to the CAISO and receiving all CAISO markets results from the CAISO; provided that a CAISO market result where the Facility is instructed to deliver zero (0) kWhs is not considered a “Schedule” for purposes of this Agreement.

“Seller Excuse Hours” means those hours during which Seller is unable to schedule or deliver Energy to Buyer as a result of (a) a Force Majeure event, (b) Buyer’s failure to perform, or (c) curtailment under Section 6.8.

“Seller’s WREGIS Account” has the meaning set forth in Section 4.3.1. *[for Facilities (1) 500 kW or greater and (2) eligible for a CAISO revenue meter.]*

“Settlement Amount” has the meaning set forth in Section 14.5.1.

“Settlement Interval” means any one of the six ten (10) minute time intervals beginning on any hour and ending on the next hour (e.g. 12:00 to 12:10, 12:10 to 12:20, etc.).

“Site” means the real property on which the Facility is, or will be, located, as further described in Appendix E.

“Site Control” means the Seller: (a) owns the Site, (b) leases the Site, (c) is the holder of a right-of-way grant or similar instrument with respect to the Site, or (d) prior to the Commercial Operation Date, has the unilaterally exercisable contractual right to acquire or cause to be acquired on its behalf any of (a), (b), or (c).

“Site Host Load” means the electric energy produced by or associated with the Facility that serves electrical loads (that are not Station Use) of Seller or one or more third parties conducted pursuant to California Public Utilities Code Section 218(b).

“Station Use” means energy consumed within the Facility’s electric energy distribution system as losses, as well as energy used to operate the Facility’s auxiliary equipment. The auxiliary equipment may include, but is not limited to, forced and induced draft fans, cooling towers, boiler feeds pumps, lubricating oil systems, plant lighting, fuel handling systems, control systems, and sump pumps.

RENEWABLE MARKET ADJUSTING TARIFF POWER PURCHASE AGREEMENT

APPENDIX A - DEFINITIONS

“Telemetry System” means a system of electronic components that collects all required telemetry in accordance with the CAISO’s Business Practice Manual for direct telemetry, the PIRP/EIRP and Buyer operational requirements and communicates this telemetry to the CAISO and Buyer as required by applicable tariff or this Agreement. The Telemetry System does not include other components of the Facility that do not collect or communicate such required telemetry, including but not limited to, Seller’s system control and data acquisition systems.

“Term” has the meaning set forth in Section 3.4.1.

“TOD Periods” means the time of delivery periods set forth in Appendix C.

“Transaction” means the particular transaction described in Section 3.3.

“Transmission Delay” has the meaning set forth in Section 2.8.2.2.

“Transmission/Distribution Owner” means any entity or entities responsible for the interconnection of the Facility or transmitting the Delivered Energy on behalf of Seller from the Facility to the Delivery Point.

“Useful Thermal Energy Output” has the meaning set forth in 18 CFR §292.202(h) and modified by the Energy Policy Act of 2005, or any successor thereto. *[for cogeneration Facilities]*

“WECC” means the Western Electricity Coordinating Council, the regional reliability council for the Western United States, Northwestern Mexico and Southwestern Canada.

“Wind Turbines” means the wind turbine generators installed on the Site as part of the Facility including any replacements or substitutes therefore. *[for wind technology]*

“WMDVBE” means women, minority and disabled veteran-owned business enterprise as contemplated by CPUC General Order 156.

“WREGIS” means the Western Renewable Energy Generating Information System or any successor renewable energy tracking program.

“WREGIS Certificate Deficit” has the meaning set forth in Section 4.3.5. *[for Facilities (1) 500 kW or greater and (2) eligible for a CAISO revenue meter.]*

“WREGIS Certificates” has the same meaning as “Certificate” as defined by WREGIS in the WREGIS Operating Rules and are designated as eligible for complying with the California Renewables Portfolio Standard. *[for Facilities (1) 500 kW or greater and (2) eligible for a CAISO revenue meter.]*

RENEWABLE MARKET ADJUSTING TARIFF POWER PURCHASE AGREEMENT

APPENDIX A - DEFINITIONS

“WREGIS Operating Rules” means those operating rules and requirements adopted by WREGIS as of December 2010, as subsequently amended, supplemented or replaced (in whole or in part) from time to time. *[for Facilities (1) 500 kW or greater and (2) eligible for a CAISO revenue meter.]*

*** *End of Appendix A* ***



**RENEWABLE MARKET ADJUSTING TARIFF
POWER PURCHASE AGREEMENT
APPENDIX B - COMMERCIAL OPERATION DATE
CONFIRMATION LETTER**

Appendix B – Commercial Operation Date Confirmation Letter

In accordance with the terms of that certain Small Renewable Generator Power Purchase Agreement dated _____ (“Agreement”) for the Facility named _____ by and between Pacific Gas and Electric Company (“Buyer”) and _____ (“Seller”), this letter serves to document the Parties further agreement that (i) the conditions precedent to the occurrence of the Commercial Operation Date have been satisfied, and (ii) Seller has scheduled and Buyer has received the Energy, as specified in the Agreement, as of this ____ day of _____, _____. This letter shall confirm the Commercial Operation Date, as defined in the Agreement, as the date referenced in the preceding sentence.

IN WITNESS WHEREOF, each Party has caused this Agreement to be duly executed by its authorized representative as of the date of last signature provided below:

By:

By:

(Seller)

**PACIFIC GAS AND ELECTRIC
COMPANY**

(Buyer)

(Signature)

(Signature)

(Type/Print Name)

(Type/Print Name)

(Title)

(Title)

(Date)

(Date)

*** End of Appendix B ***

**RENEWABLE MARKET ADJUSTING TARIFF
POWER PURCHASE AGREEMENT
APPENDIX C - TIME OF DELIVERY PERIODS AND
PAYMENT ALLOCATION FACTORS**

**Appendix C – Time of Delivery Periods and Payment
Allocation Factors**

Energy-Only Payment Allocation Factors

Monthly Period	Super-Peak	Shoulder	Night
Jun – Sep	1.157	1.011	0.951
Oct.- Dec., Jan. & Feb.	1.071	1.018	0.963
Mar. – May	0.907	0.937	0.987

Full Capacity Deliverability Payment Allocation Factors

Monthly Period	Super-Peak	Shoulder	Night
Jun – Sep	2.297	1.069	0.798
Oct.- Dec., Jan. & Feb.	0.953	0.857	0.808
Mar. – May	1.041	0.819	0.828

Definitions:

1. Super-Peak (5x8) = HE (Hours Ending) 13 – 20 (Pacific Prevailing Time (PPT)), Monday - Friday (*except* NERC holidays) in the applicable Monthly Period.
2. Shoulder = HE 7 - 12, 21 and 22 PPT Monday - Friday (*except* NERC holidays); and HE 7 - 22 PPT Saturday, Sunday and *all* NERC holidays in the applicable Monthly Period.
3. Night (7x8) = HE 1 - 6, 23 and 24 PPT all days (*including* NERC holidays) in the applicable Monthly Period.

“NERC Holidays” mean the following holidays: New Year’s Day, Memorial Day, Independence Day, Labor Day, Thanksgiving Day, and Christmas Day. Three of these days, Memorial Day, Labor Day, and Thanksgiving Day occur on the same day each year. Memorial Day is the last Monday in May; Labor Day is the first Monday in September; and Thanksgiving Day is the 4th Thursday in November.

**RENEWABLE MARKET ADJUSTING TARIFF
POWER PURCHASE AGREEMENT
APPENDIX C - TIME OF DELIVERY PERIODS AND
PAYMENT ALLOCATION FACTORS**

New Year's Day, Independence Day, and Christmas Day, by definition, are predetermined dates each year. However, in the event they occur on a Sunday, the "NERC Holiday" is celebrated on the Monday immediately following that Sunday. However, if any of these days occur on a Saturday, the "NERC Holiday" remains on that Saturday.

*** *End of Appendix C* ***

**RENEWABLE MARKET ADJUSTING TARIFF
POWER PURCHASE AGREEMENT
APPENDIX D - FORECASTING AND OUTAGE
NOTIFICATION REQUIREMENTS**

Appendix D – Forecasting and Outage Notification Requirements

A. NOTIFICATION REQUIREMENTS FOR START-UP AND SHUTDOWN

Prior to paralleling to or after disconnecting from the electric system, ALWAYS follow your balancing authority rules and notify your applicable Transmission/Distribution Owner local switching center and notify Buyer's Real Time Desk by telephone as follows:

- Contact the applicable Transmission/Distribution Owner local switching center and Buyer's Real Time Desk to parallel before any start-up
- Contact the applicable Transmission/Distribution Owner local switching center and Buyer's Real Time Desk again with parallel time after start-up.
- Contact the applicable Transmission/Distribution Owner local switching center and Buyer's Real Time Desk after any separation and report the separation time as well as the date and time estimate for return to service.

Buyer's Real Time Desk Primary Telephone: (415) 973-4500.

B. SUBMISSION OF AVAILABLE CAPACITY AND PROJECT OUTAGES

1. Submit information by posting to PG&E's approved web-based system.
2. If the website is unavailable, implement the procedures set forth below:
 - a. **For all email correspondence, enter the following in the email subject field: Contract Name, Email Purpose, Delivery Date Range, (For example: "XYZ Company Project #2 Daily Forecast of Available Capacity for dd/mm/yyyy through dd/mm/yyyy")**
 - b. For Annual Forecasts of Available Capacity, email to DAenergy@pge.com and Bilat Settlements@pge.com.
 - c. For Monthly and Day Ahead Forecasts of Available Capacity, email to DAenergy@pge.com.
 - d. For Day Ahead Forecasts of Available Capacity after fourteen (14) hours before the WECC Preschedule Day, but before the CAISO deadline for

**RENEWABLE MARKET ADJUSTING TARIFF
POWER PURCHASE AGREEMENT
APPENDIX D - FORECASTING AND OUTAGE
NOTIFICATION REQUIREMENTS**

- submitting Day-Ahead Schedules, call primary phone (415) 973-1971 or backup phone (415) 973-4500. Also send email to DAenergy@pge.com.
- e. For Hourly Forecasts of Available Capacity, call PG&E's Real Time Desk at (415) 973-4500 and email to RealTime@pge.com.
 - f. For Planned Outages and prolonged outages, complete the specifics below and submit by email to DAenergy@pge.com and Bilat_Settlements@pge.com.
 - g. For Forced Outages, complete the specifics below and submit by email to RealTime@pge.com and Bilat_Settlements@pge.com.
 - i. **Email subject Field: XYZ Company Project #2 Outage Notification for dd/mm/yyyy through dd/mm/yyyy**
 - ii. **Email body:**
 - 1. **Type of Outage: Planned Outage, Forced Outage, Prolonged Outage**
 - 2. **Start Date and Start Time**
 - 3. **Estimated or Actual End Date and End Time**
 - 4. **Date and time when reported to PG&E and name(s) of PG&E representative(s) contacted**
 - 5. **Text description of additional information as needed, including, but not limited to, changes to a Planned Outage, Prolonged Outage or Forced Outage.**

C. AVAILABLE CAPACITY FORECASTING.

Seller shall provide the Available Capacity forecasts described below. ***[The following bracketed language applies to As-Available solar or wind Projects only]*** [Seller's availability forecasts below shall include Project availability and updated status of ***[The following bracketed language applies to solar Projects only]*** [photovoltaic panels, inverters, transformers, and any other equipment that may impact availability] or ***[The following bracketed language applies to wind Projects only]*** [transformers, wind turbine unit status, and any other equipment that may impact availability].] ***[The following bracketed language applies to As-Available Product only]*** Seller shall use commercially reasonable efforts to forecast the Available Capacity of the Project accurately and to transmit such information in a format reasonably acceptable to Buyer. Buyer and Seller shall agree upon reasonable changes to the requirements and

RENEWABLE MARKET ADJUSTING TARIFF POWER PURCHASE AGREEMENT

APPENDIX D - FORECASTING AND OUTAGE NOTIFICATION REQUIREMENTS

procedures set forth below from time-to-time, as necessary to comply with CAISO Tariff changes, accommodate changes to their respective generation technology and organizational structure and address changes in the operating and Scheduling procedures of Buyer and the CAISO, including but not limited to automated forecast and outage submissions.

1. Annual Forecast of Available Capacity. No later than (I) the earlier of July 1 of the first calendar year following the Execution Date or one hundred and eighty (180) days before the first day of the first Contract Year of the Delivery Term (“First Annual Forecast Date”), and (II) on or before July 1 for each calendar year from the First Annual Forecast Date for every subsequent Contract Year during the Delivery Term, Seller shall provide to Buyer a non-binding forecast of the hourly Available Capacity for each day in each month of the following calendar year in a form reasonably acceptable to Buyer.

2. Monthly Forecast of Available Capacity. Ten (10) Business Days before the beginning of each month during the Delivery Term, Seller shall provide to Buyer a non-binding forecast of the hourly Available Capacity for each day of the following month in a form reasonably acceptable to Buyer.

3. Day-Ahead Forecast of Available Capacity. During each month of the Delivery Term, Seller or Seller’s agent shall provide a binding day ahead forecast of Available Capacity (the “Day-Ahead Availability Notice”) to Buyer via Buyer’s internet website for each day no later than fourteen (14) hours before the beginning of the “Preschedule Day” (as defined by the WECC) for such day. For Baseload Facilities, Seller or Seller’s agent shall also provide a binding day ahead forecast of hourly Delivered Energy under the same constraints and timing as above. The current industry standard Preschedule Day timetable in the WECC is as follows:

- (1) Monday - Preschedule Day for Tuesday
- (2) Tuesday - Preschedule Day for Wednesday
- (3) Wednesday - Preschedule Day for Thursday
- (4) Thursday - Preschedule Day for Friday and Saturday
- (5) Friday - Preschedule Day for Sunday and Monday

Exceptions to this standard Monday through Friday Preschedule Day timetable are presently set forth by the WECC in order to accommodate holidays, monthly transitions and other events. Exceptions are posted on the WECC website (www.wecc.biz) under the document title, “Preschedule Calendar.” Each Day-Ahead Availability Notice shall clearly identify, for each hour, Seller’s forecast of all amounts of

**RENEWABLE MARKET ADJUSTING TARIFF
POWER PURCHASE AGREEMENT
APPENDIX D - FORECASTING AND OUTAGE
NOTIFICATION REQUIREMENTS**

Available Capacity pursuant to this Agreement. If the Available Capacity changes by at least one (1) MW (AC) as of a time that is more than fourteen (14) hours prior to the Preschedule Day but prior to the CAISO deadline for Day-Ahead Schedules, then Seller must notify Buyer of such change by telephone and shall send a revised notice to Buyer's internet website. Such Notices shall contain information regarding the beginning date and time of the event resulting in the change in Available Capacity, the expected end date and time of such event, the expected Available Capacity in MW (AC), and any other necessary information.

Day-Ahead Desk
Primary Telephone: (415) 973-1971
Backup Telephone: (415) 973-4500

If Seller fails to provide Buyer with a Day-Ahead Availability Notice as required herein, then, (I) until Seller provides a Day-Ahead Availability Notice, Buyer may rely on the most recent Day-Ahead Forecast of Available Capacity submitted by Seller to Buyer and Seller and (II) Seller may be subject to penalties and charges as provided in this Agreement.

4. Hourly Forecast of Available Capacity. During the Delivery Term, Seller shall notify Buyer of any changes in Available Capacity of one (1) MW (AC) or more, whether due to Forced Outage, Force Majeure or other cause, as soon as reasonably possible, but no later than one (1) hour before Buyer is required to submit Hour-Ahead schedules to the CAISO. Available Capacity changes after one (1) hour before the CAISO deadline for Hour-Ahead Schedules, but before the CAISO Hour-Ahead deadline, shall also be reported by Seller to Buyer as soon as reasonably possible. Such Notices shall contain information regarding the beginning date and time of the event resulting in the change in Available Capacity, the expected end date and time of such event, the expected Available Capacity in MW (AC), and any other information required by the CAISO or reasonably requested by Buyer. With respect to any Forced Outage, Seller shall use commercially reasonable efforts to notify Buyer of such outage within ten (10) minutes of the commencement of the Forced Outage. Seller shall inform Buyer of any developments that will affect either the duration of such outage or the availability of the Project during or after the end of such outage. These notices and changes to Available Capacity shall be communicated by telephone to Buyer's Hour-Ahead Trading Desk and shall be sent to Buyer's internet website:

Hour-Ahead Desk
Primary Telephone: (415) 973-4500

5. Buyer Provision of Forecasting Services. Seller may request that Buyer perform forecasting services required by this Appendix D if it is reasonably practicable for such forecasting services to be performed by a person or entity other than Seller. Buyer may perform such services directly or retain a third-

**RENEWABLE MARKET ADJUSTING TARIFF
POWER PURCHASE AGREEMENT
APPENDIX D - FORECASTING AND OUTAGE
NOTIFICATION REQUIREMENTS**

party to perform such services. Buyer may charge a reasonable fee for any such services, which, in the case Buyer retains a third-party, may include a reasonable administration fee in addition to the fee any such third-party charges Buyer.

**** End of Appendix D ****

Appendix E – Description of the Facility

Seller should complete the information below and attach a description of the Facility, including a summary of its significant components, a drawing showing the general arrangements of the Facility, and a single line diagram illustrating the interconnection of the Facility and loads with Buyer's electric distribution system.

Name of the Facility: _____

Address of the Facility: _____

Description of the Facility, including a summary of its significant components, such as [Photovoltaic Modules, DC Collection System, Current Inverters *[for solar photovoltaic technology]*] [generator system and the thermal system equipment, including heat recovery system, heat exchangers, absorption chillers, boilers, or furnaces *[for cogeneration Facilities]*], meteorological station, solar irradiance instrumentation and any other related electrical equipment:

Drawing showing the general arrangement of the Facility:

A single-line diagram illustrating the interconnection of the Facility with Buyer:

A legal description of the Site, including a Site map:

Longitude and latitude of the centroid of the Site:

Forecast of the Useful Thermal Energy Output (MMBtu/month) *[for cogeneration Facilities]*:

Dedicated Use(s) of the Facility's Useful Thermal Energy Output *[for cogeneration Facilities]*:

*** End of Appendix E ***

Project: Putah Creek Solar Farm is a 2.49MWDC / 2MW AC solar project utilizing commercially proven photovoltaic modules, inverters and interconnection equipment. The energy sale transaction is Full Buy/Sell. The project will utilize single axis tracking systems to maximize solar generation of the PV modules, especially during peak demand hours of 2PM-8PM, June 1- September 30. The current land use is agricultural. The APN is: 030-200-36.

Address: Corner of Highway 128 and County Road 87D, Winters, CA 95694

Coordinates in decimals:

Latitude : 38.52158997246891, Longitude : -121.994796706607

Interconnection Details: The project, Q#: 0141-WD, will interconnect to the PG&E 12.47kV distribution grid running parallel with the project site's northern property boundary. The Point of Interconnection is located on the northern side of the project site, adjacent to the Putah Creek Substation. Per the provided Interconnection Agreement, the project will interconnect to Putah Creek Circuit #1102 at 12.47kV and will incur no network upgrade costs.

The project's interconnection agreement has been signed and executed between PG&E and Putah Creek Solar Farms LLC. Financial security for the interconnection work has been posted per PG&E requirements. The expected commercial operation date is February 1, 2015 although it is likely the project could be online sooner given its mature permitting and interconnection status.

Permitting: The project has received a Conditional Use Permit from Yolo County, dated July 12, 2013.

Technical Details: The project will utilize commercial grade 275 watt photovoltaic modules from Suntech Power Inc. or an equivalent commercially proven vendor. The project will utilize (4) 500KW Advanced Energy Solaron Inverters. These inverters are in use across PG&E territory including the 5MW Sunset Reservoir site in San Francisco. The AE inverters are well known and accepted by PG&E as state of the art solar inverter systems.

Solar PV	
Equipment	Description
PV Modules	Suntech STP275-24/Vd Watt or commercially proven equivalent
Inverters	Advanced Energy Solaron 500KW
Step-up transformer	1MVA 200V/12.47kV (2 units)

Generation: The project is expected to generate 5 GWH in Year 1 and more than 80 GWH over the life of the PPA with PG&E.

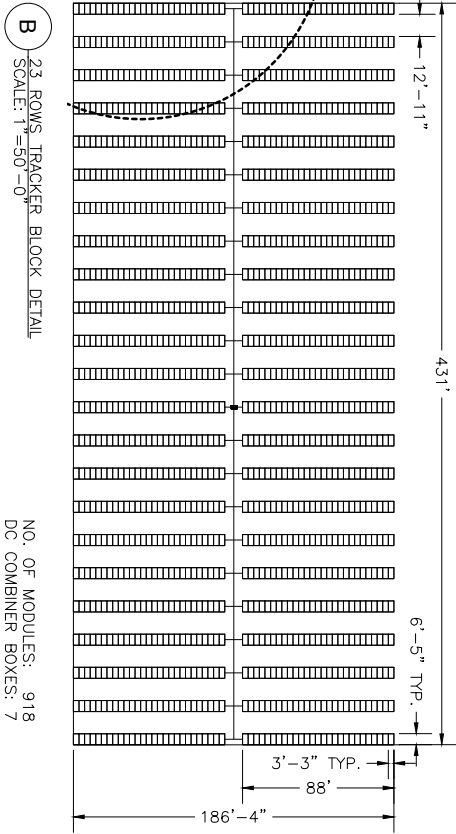
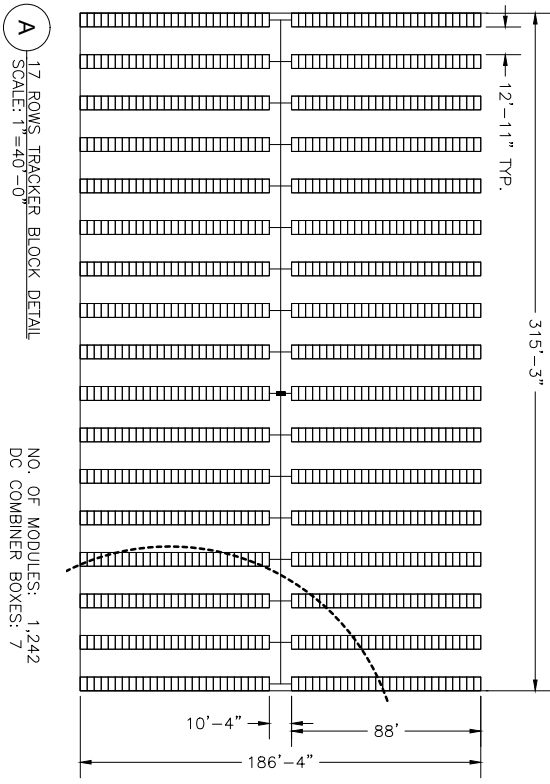

NOTES:

A. 15KV SWITCH GEAR IS APPROXIMATELY 100 FT FROM PUTAH CREEK CIRCUIT #1102.

B. 1MW INVERTER PAD INCLUDES 480V-12.47KV TRANSFORMER, 2 X 500KW INVERTERS, DC RECOMBINER AND 480V-120V STEP DOWN TRANSFORMER FOR LOCAL 120V POWER USE.

ARRAY INFORMATION	
MODULE TYPE	SUNTECH Z75 OR EQUIVALENT
TOTAL MODULE COUNT	9,064
MODULE STC-DC SIZE	275W
TOTAL STC-DC SIZE	2,49MWP
NO. OF INVERTERS	4

SEAL:

CLIENT: PUTAH CREEK SOLAR FARMS LLC

DESCRIPTION	DATE	BY
01 FIRST REV	10-DEC-10	-
02 SECOND REV	16-DEC-10	-
03 THIRD REV	08-MAY-13	-
04 FOURTH REV	09-MAY-13	-
06 SIXTH REV	26-AUG-13	-
07 SEVENTH REV	30-SEP-13	-



FACILITY DRAWING

PROJECT: PUTAH CREEK SOLAR FARMS WINTERS, CA 95694

DATE	SCALE
26-AUG-13	1:800

PROJECT NO.	SIZE	DWG NAME
24	36"	A.2.1

SHEET: A.2.1

← PHOTOVOLTAIC FIELD → INVERTER AND TRANSFORMER TO MEDIUM VOLTAGE (4 X 500KW UNITS) → MEDIUM VOLTAGE S/G & NETWORK → O/H TO (E) PG&E DISTRIBUTION

(ESTIMATED: 9,064 x 275W PV PANELS IN 824 STRINGS IN 1-AXIS TRACKER ORIENTATION)

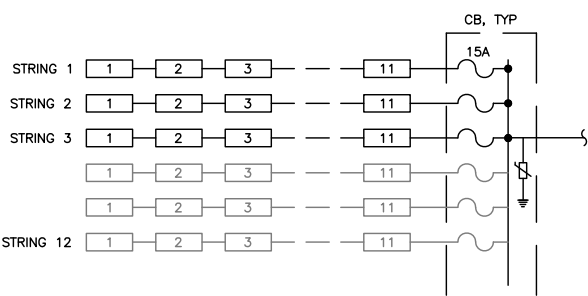
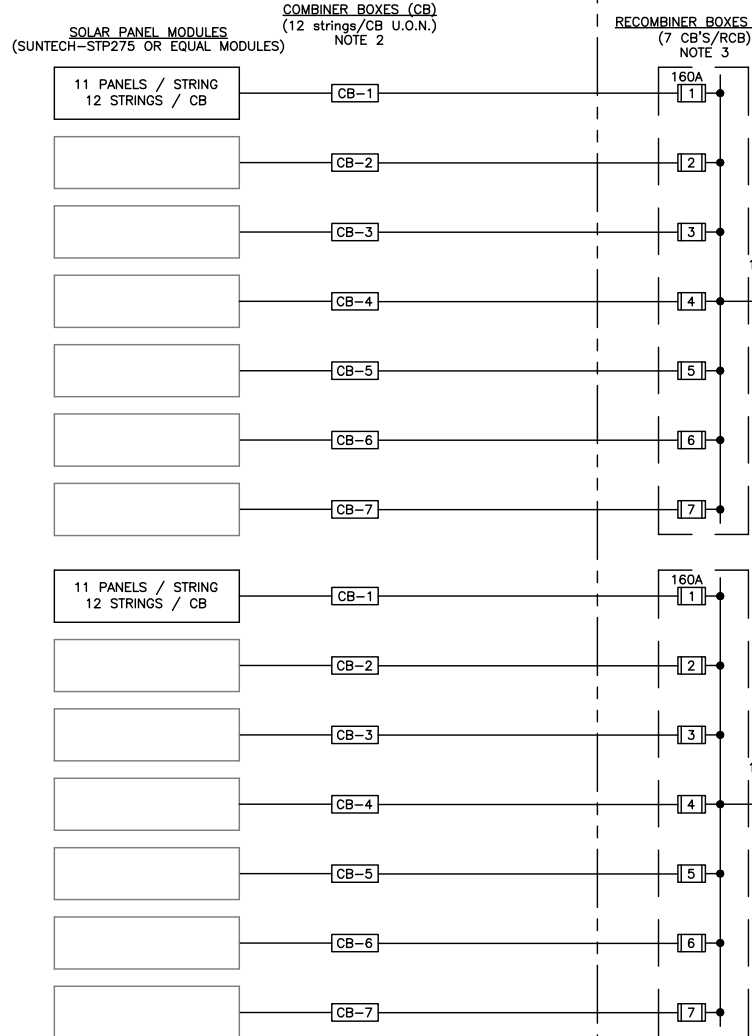

DETAIL OF SOLAR PANELS AND COMBINER BOX FOR SUNTECH 280W PANEL

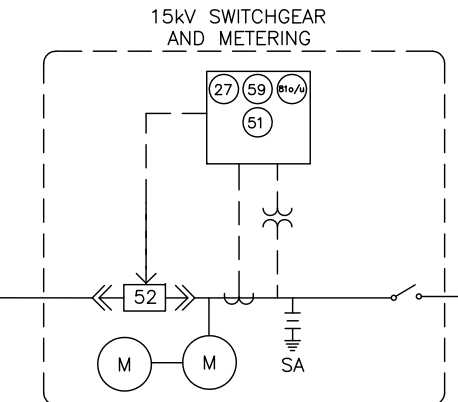
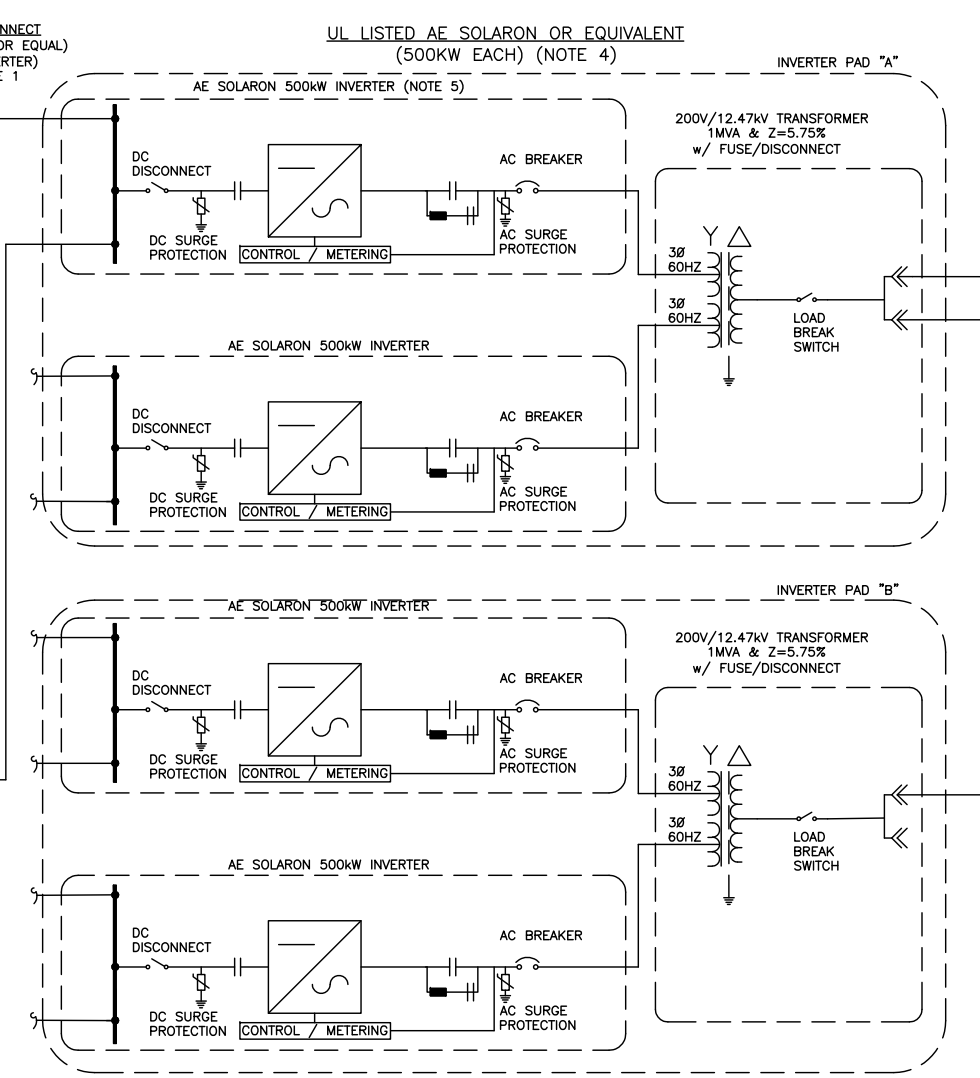

(E) PG&E DISTRIBUTION
PUTAH CREEK
CIRCUIT #1102

- NOTES:
- 1) TWO 2-POLE DC DISCONNECTS BY SQUARE D (OR EQUAL) RATED AS SHOWN PER EACH 500KW INVERTER.
 - 2) EACH STRING CONSISTS OF 11 PANELS AND EACH COMBINER BOX (CB) CONTAINS 12 STRINGS, THAT IS 121 PANELS/CB.
 - 3) THERE ARE TWO RECOMBINER BOXES (RCB) FOR EACH 500KW INVERTER, EACH CONTAINING THE OUTPUTS FROM SEVEN COMBINER BOXES. RECOMBINER BOXES AND THE DISCONNECTS SHALL BE SITUATED CLOSE TO THE INVERTER PACKAGE.
 - 4) BASED ON FINAL LAYOUT, NUMBER AND SIZE OF INVERTERS AND TRANSFORMERS MAY CHANGE TO OPTIMIZE ENERGY PRODUCTION.
 - 5) FULL PROTECTION INCLUDING GROUND FAULT INTERRUPTION IS ALSO PROVIDED BY THE INVERTERS ON THE LV SIDE.

ELECTRICAL BLOCK DIAGRAM

SOLVIDA
ENERGY GROUP

CLIENT: PUTAH CREEK SOLAR FARMS

DATE: 26-AUG-13

SINGLE LINE DIAGRAM
PUTAH CREEK SOLAR FARMS
WINTERS, CA 95694

DATE	SCALE	
26-AUG-13	NTS	
PROJECT	SIZE	DWG#
SHE1-24"x36"		A.2.1

E.2.1

SEAL:



VICINITY MAP OF PUTAH CREEK SOLAR FARM
(Q#: 0141-WD), WINTERS, CA 95694



- NOTES:
- A. 15KV SWITCH GEAR IS APPROXIMATELY 100 FT FROM PUTAH CREEK CIRCUIT #1102.
 - B. 1MW INVERTER PAD INCLUDES 480V-12.47KV TRANSFORMER, 2 X 500KW INVERTERS, DC RECOMBINER AND 480V-120V STEP DOWN TRANSFORMER FOR LOCAL 120V POWER USE.

SITE ADDRESS:
CORNER OF COUNTY ROAD 87D AND HIGHWAY 128,
WINTERS, CA 95694
LATITUDE: : 38.5219855366191 , LONGITUDE: -121.994922770431

ARRAY INFORMATION	
MODULE TYPE	SUNTECH 275 OR EQUIVALENT
TOTAL MODULE COUNT	9,064
MODULE STC-DC SIZE	275W
TOTAL STC-DC SIZE	2,49MWP
NO. OF INVERTERS	4

DATE: 26-AUG-13
SCALE: 1:1,000
PROJECT NO.: 24 X36"
SHEET: A.1.1

PUTAH CREEK SOLAR FARMS
WINTERS, CA 95694

CLIENT: PUTAH CREEK SOLAR FARMS LLC

DESCRIPTION	DATE	BY
01 FIRST REV	10-DEC-10	-
02 SECOND REV	16-DEC-10	-
03 THIRD REV	08-MAY-13	-
04 FOURTH REV	09-MAY-13	-
07 SEVENTH REV	30-SEP-13	-
12 TWELFTH REV	02-DEC-13	-



Appendix F – Telemetry Requirements

1. Telemetering System.

Seller shall install a Telemetering System at the Facility. *[Applicable to all Facilities]*

Notwithstanding the foregoing, Seller shall not be required to install a data processing gateway and, if directed by Buyer, Seller shall participate in Buyer's aggregated Telemetering System ("Aggregated Telemetering System"). In no event shall the Aggregated Telemetering System Installation Costs exceed Twenty Thousand dollars (\$20,000.00) (the "Aggregated Telemetering Cost Cap"); provided that if the Aggregated Telemetering System Installation Costs exceed the Aggregated Telemetering Cost Cap then Buyer shall have the right, but not the obligation, in its sole discretion, to agree to pay for such costs in excess of the Aggregated Telemetering Cost Cap. To the extent requested by Buyer, Seller shall provide evidence of the Aggregated Telemetering System Installation Costs satisfactory to Buyer. *[Only applicable if Facility is less than 500 kW]*

The above-mentioned connections and data transfer must be included in the systems engineering tasks as a part of the construction of the Facility, and must be fully functional before Commercial Operation Date.

2. Additional Data Requirements.

Seller shall comply with the telemetry parameters set forth in the Meteorological Data Requirements table below and meet the meteorological data requirements pursuant to the CAISO's Business Practice Manual for Direct Telemetry. Prior to Commercial Operation Date, if the Facility uses a technology type identified in the table below, Seller shall demonstrate to Buyer's reasonable satisfaction that Seller has installed equipment capable of complying with the requirements of this Section 2.

RENEWABLE MARKET ADJUSTING TARIFF POWER PURCHASE AGREEMENT

APPENDIX F - TELEMETRY REQUIREMENTS

Meteorological Data Requirements				
Technology Type	Telemetry Parameters	Units	Accuracy	
Solar Photovoltaic	Back Panel Temperature	°C	± 1 ⁰	
	Global Horizontal Irradiance	W/m ²	± 25 W/m ²	
	Plane of Array Irradiance (If PV is fixed) Direct Normal Irradiance (If PV is Tracking)	W/m ²	± 25 W/m ²	
	Wind Speed	m/s	± 1 m/s	
	Peak Wind Speed (Within 1 minute)	m/s	± 1 m/s	
	Wind Direction	Degrees	± 5 ⁰	
	Ambient Air Temperature	°C	± 1 ⁰	
	Dewpoint Air Temperature	°C	± 1 ⁰	
	Horizontal Visibility	m	--	
	Precipitation (Rain Rate)	mm/hr	--	
	Precipitation (Running 30 day total)	mm	--	
	Barometric Pressure	Hecto Pascals (HPa)	± 60 Pa	
	Solar Thermal or Solar Trough	Global Horizontal Irradiance	W/m ²	± 25 W/m ²
		Plane of Array Irradiance (If PV is fixed) Direct Normal Irradiance (If PV is Tracking)	W/m ²	± 25 W/m ²
Wind Speed		m/s	± 1 m/s	
Peak Wind Speed (Within 1 minute)		m/s	± 1 m/s	
Wind Direction		Degrees	± 5 ⁰	
Ambient Air Temperature		°C	± 1 ⁰	
Dewpoint Air Temperature		°C	± 1 ⁰	
Horizontal Visibility		m	--	
Precipitation (Rain Rate)		mm/hr	--	
Precipitation (Running 30 day total)		mm	--	
Barometric Pressure		Hecto Pascals (HPa)	± 60 Pa	
Wind		Wind Speed	m/s	± 1 m/s
		Peak Wind Speed (Within 1 minute)	m/s	± 1 m/s
		Wind Direction	Degrees	± 5 ⁰

**RENEWABLE MARKET ADJUSTING TARIFF
POWER PURCHASE AGREEMENT**

APPENDIX F - TELEMETRY REQUIREMENTS

Meteorological Data Requirements			
	Wind Speed Standard Deviation	--	--
	Wind Direction Standard Deviation	--	--
	Barometric Pressure	Hecto Pascals (HPa)	± 60 Pa
	Ambient Temperature	°C	± 1 ⁰

*** End of Appendix F ***

**RENEWABLE MARKET ADJUSTING TARIFF
POWER PURCHASE AGREEMENT
APPENDIX G - GUARANTEED ENERGY
PRODUCTION DAMAGES**

Appendix G – Guaranteed Energy Production Damanges

In accordance with the provisions in Section 12.2, GEP Damages means the liquidated damages payment due by Seller to Buyer, calculated as follows:

$$[(A-B) \times (C-D)]$$

Where:

A = the Guaranteed Energy Production for the Performance Measurement Period, in MWh

B = Sum of Delivered Energy over the Performance Measurement Period, in MWh

C = Replacement price for the Performance Measurement Period, in \$/MWh, reflecting the sum of (a) the simple average of the simple average of the Day Ahead Integrated Forward Market hourly price, as published by the CAISO, for the Existing Zone Generation Trading Hub, in which the Project resides, plus (b) \$50/MWh

D = the unweighted Contract Price for the Performance Measurement Period, in \$/MWh

The Parties agree that in the above calculation of GEP Damages, the result of “(C-D)” shall not be less than \$20/MWh and shall be no greater than seventy five percent (75%) of the Contract Price (in \$/MWh).

*** End of Appendix G ***



RENEWABLE MARKET ADJUSTING TARIFF
POWER PURCHASE AGREEMENT
APPENDIX H - FORM OF LETTER OF CREDIT

Appendix H – Form of Letter of Credit

Issuing Bank Letterhead and Address

STANDBY LETTER OF CREDIT NO. _____

Date: _____ [insert issue date]

Beneficiary: Pacific Gas and Electric Company
77 Beale Street, Mail Code B28L
San Francisco, CA 94105
Attention: Credit Risk Management

Applicant: [Insert name and address of Applicant]

Letter of Credit Amount: _ [insert amount]

Expiry Date: _____ [insert expiry date]

Ladies and Gentlemen:

By order of _____ [insert name of Applicant]
("Applicant"), we hereby issue in favor of Pacific Gas and Electric Company (the
"Beneficiary") our irrevocable standby letter of credit No. _____ [insert
number of letter of credit] ("Letter of Credit"), for the account of Applicant, for drawings
up to but not to exceed the aggregate sum of U.S. \$ _____
_____ [insert amount in figures
followed by (amount in words)] ("Letter of Credit Amount"). This Letter of Credit is
available with _____

[insert name of issuing bank, and the city and state in which it is located] by sight
payment, at our offices located at the address stated below, effective immediately, and
it will expire at our close of business on _____ [insert
expiry date] (the "Expiry Date").

Funds under this Letter of Credit are available to the Beneficiary against presentation of
the following documents:

- 1. Beneficiary's signed and dated sight draft in the form of Exhibit A hereto,
referencing this Letter of Credit No. _____ [insert number] and stating
the amount of the demand; and

**RENEWABLE MARKET ADJUSTING TARIFF
POWER PURCHASE AGREEMENT
APPENDIX H - FORM OF LETTER OF CREDIT**

2. One of the following statements signed by an authorized representative or officer of Beneficiary:

A. "Pursuant to the terms of that certain Power Purchase Agreement ("PPA"), dated _____, between Beneficiary and _____ *[insert name of Seller under the PPA]*, Beneficiary is entitled to draw under Letter of Credit No. _____ *[insert number]* amounts owed by _____ *[insert name of Seller under the PPA]* under the PPA; or

B. "Letter of Credit No. _____ *[insert number]* will expire in thirty (30) days or less and _____ *[insert name of Seller under the PPA]* has not provided replacement security acceptable to Beneficiary.

Special Conditions:

1. Partial and multiple drawings under this Letter of Credit are allowed;
2. All banking charges associated with this Letter of Credit are for the account of the Applicant;
3. This Letter of Credit is not transferable;
4. A drawing for an amount greater than the Letter of Credit Amount is allowed, however, payment shall not exceed the Letter of Credit Amount; and
5. The Expiry Date of this Letter of Credit shall be automatically extended (without an amendment hereto) for a period of one (1) year from the Expiry Date or any future Expiry Date, unless _____ *[insert name of Seller under the PPA]* has provided replacement security acceptable to Beneficiary, or Beneficiary has returned this Letter of Credit to _____ *[insert name of Seller under the PPA]* prior to the Expiry Date.

We engage with you that drafts drawn under and in compliance with the terms of this Letter of Credit will be duly honored upon presentation, on or before the Expiry Date (or after the Expiry Date as provided below), at our offices at *[insert issuing bank's address for drawings]*.

All demands for payment shall be made by presentation of originals or copies of documents; or by facsimile transmission of documents to *[insert fax number]*, Attention: *[insert name of issuing bank's receiving department]*, with originals or copies of documents to follow by overnight mail. If presentation is made by facsimile transmission, you may contact us at *[insert phone number]* to confirm our receipt of the transmission. Your failure to seek such a telephone confirmation does not affect our obligation to honor such a presentation.



**RENEWABLE MARKET ADJUSTING TARIFF
POWER PURCHASE AGREEMENT
APPENDIX H - FORM OF LETTER OF CREDIT**

Our payments against complying presentations under this Letter of Credit will be made no later than on the sixth (6th) banking day following a complying presentation.

Except as stated herein, this Letter of Credit is not subject to any condition or qualification. It is our individual obligation, which is not contingent upon reimbursement and is not affected by any agreement, document, or instrument between us and the Applicant or between the Beneficiary and the Applicant or any other party.

Except as otherwise specifically stated herein, this Letter of Credit is subject to and governed by the *Uniform Customs and Practice for Documentary Credits, 2007 Revision*, International Chamber of Commerce (ICC) Publication No. 600 (the "UCP 600"); provided that if this Letter of Credit expires during an interruption of our business as described in Article 36 of the UCP 600, we will honor drafts presented in compliance with this Letter of Credit within thirty (30) days after the resumption of our business and effect payment accordingly.

The law of the State of New York shall apply to any matters not covered by the UCP 600.

For telephone assistance regarding this Letter of Credit, please contact us at *[insert number and any other necessary details]*.

Very truly yours,

[insert name of issuing bank]

By: _____
Authorized Signature

Name _____
[print or type name]

Title: _____



RENEWABLE MARKET ADJUSTING TARIFF
POWER PURCHASE AGREEMENT
APPENDIX H - FORM OF LETTER OF CREDIT

Exhibit A SIGHT DRAFT

TO _____
[INSERT NAME AND ADDRESS OF PAYING BANK]

AMOUNT: \$ _____ DATE: _____

AT SIGHT OF THIS DEMAND PAY TO THE ORDER OF PACIFIC GAS AND ELECTRIC COMPANY THE AMOUNT OF U.S. \$ _____ U.S. DOLLARS)

DRAWN UNDER _____
[INSERT NAME OF ISSUING BANK] LETTER OF CREDIT NO. XXXXXX.

REMIT FUNDS AS FOLLOWS: _____

[INSERT PAYMENT INSTRUCTIONS]

DRAWER: _____

BY: _____

NAME AND TITLE: _____

*** End of Appendix H ***

RENEWABLE MARKET ADJUSTING TARIFF POWER PURCHASE AGREEMENT

APPENDIX J – NOTICES LIST

Appendix I - Seller's Milestone Schedule

No.	Date	Milestones
1		Submits interconnection application.
2		Files any land applications.
3		Files construction permit application(s).
4		Files a CEC Pre-Certification application.
5		Files material permit applications.
6		Receives a completed System Impact Study or Phase I Interconnection Study.
7		Obtains control of all lands and rights-of-way comprising the Site.
8		Receives a completed interconnection Facility Study or Phase II Interconnection Study.
9		Executes an interconnection agreement and transmission/distribution service agreement, as applicable.
10		Receives FERC acceptance of interconnection agreement and transmission agreement.
11		Receives construction permit.
12		Receives material permits.
13		Receives CEC Pre-Certification.
14		Receives FERC docket number assigned to Seller's filing of FERC Form 556.
15		Executes an Engineering, Procurement and Construction ("EPC") contract.
16		Procures the _____ [applicable electrical generating equipment] for the Facility.
17		Completes financing, including construction financing.
18		Begins construction of the Facility.
19		Begins startup activities.
20		Initial Synchronization Date.
21		Commercial Operation Date.
22		Demonstrates the Contract Capacity.
23		Receives CEC Certification.

*** End of Appendix I ***

RENEWABLE MARKET ADJUSTING TARIFF POWER PURCHASE AGREEMENT

APPENDIX J – NOTICES LIST

Appendix J – Notices List

Name: _____
[*Seller's Name*], a _____
_____ [*include
place of formation and business
type*] (“Seller”)

All Notices: [*Seller to complete*]

Delivery Address:

Street:

City: State: Zip:

Mail Address: (if different from above)

Attn:

Phone:

Facsimile:

DUNS:

Federal Tax ID Number:

Invoices:

Attn:

Phone:

Facsimile:

Scheduling:

Attn:

Phone:

Facsimile:

Payments:

Attn:

Phone:

Facsimile:

Wire Transfer:

Name: Pacific Gas and Electric Company, a
California corporation
 (“Buyer” or “PG&E”)

All Notices:

Delivery Address:

77 Beale Street, Mail Code N12E

San Francisco, CA 94105-1702

Mail Address:

P.O. Box 770000, Mail Code N12E

San Francisco, CA 94177

Attn: Candice Chan (CWW9@pge.com)

Director, Contract Mgmt & Settlements

Phone: (415) 973-7780

Facsimile: (415) 973-5507

DUNS:

Federal Tax ID Number:

Invoices:

Attn: Azmat Mukhtar (ASM3@pge.com)

Manager, Bilateral Settlements

Phone: (415) 973-4277

Facsimile: (415) 973-2151

Scheduling:

Attn: Mike McDermott (m0mc@pge.com)

Phone: (415) 973-4072

Facsimile: (415) 973-0400

Payments:

Attn: Azmat Mukhtar (ASM3@pge.com)

Manager, Bilateral Settlements

Phone: (415) 973-4277

Facsimile: (415) 973-2151

Wire Transfer:

RENEWABLE MARKET ADJUSTING TARIFF POWER PURCHASE AGREEMENT

APPENDIX J – NOTICES LIST

BNK:
ABA:
ACCT:

BNK:
ABA:
ACCT:

Credit and Collections:

Attn:

Phone:
Facsimile:

Credit and Collections:

Attn: Justice Awuku(J2AT@pge.com)
Manager, Credit Risk Management
Phone: (415) 973-4144
Facsimile: (415) 973-4071

With additional Notices of an Event of
Default to Contract Manager:

Attn: _____

Phone: _____
Facsimile: _____

Contract Manager:

Attn: Chad Curran (CRCq@pge.com)
Manager, Contract Management
Phone: (415) 973-6105
Facsimile: (415) 972-5507

With additional Notices of an Event of
Default to:

PG&E Law Department
Attn: Renewables Portfolio Standard
attorney
Phone: (415) 973-4377
Facsimile: (415) 972-5952

*** End of Appendix J ***

**RENEWABLE MARKET ADJUSTING TARIFF
POWER PURCHASE AGREEMENT
APPENDIX K – FORM OF GENERAL CONSENT TO
ASSIGNMENT**

Appendix K – Form of General Consent to Assignment

CONSENT TO ASSIGNMENT AND AGREEMENT

This Consent to Assignment and Agreement (“CTA”) is by and between _____ (“Buyer”), a California corporation, _____ **[Counterparty]** (“Assignor”), _____ **[Enter type of company]** and _____ **[Enter Assignee Name]** (“Assignee”), _____ **[Enter type of company]**. Buyer, Assignor and Assignee are sometimes referred to herein individually as “Party” and collectively as the “Parties”.

Buyer hereby consents to the assignment by Assignor to Assignee of the entirety of the rights, title and interest Assignor may have in and to the agreements described on Exhibit A attached hereto and incorporated herein by this reference the “Assigned Agreement(s)”, for the _____ **[Capacity_kW]** **[Fuel]** project named _____ **[Facility_description]** (**[Buyer Identification or Log No.]** **[Buyer_Lognum]**), located at _____ **[Plant_Street_Address]** **[Plant_City]**, **[Plant_State]** **[Plant_Zip_code]**, as of the date of last signature hereunder (the “Effective Date”) under the following terms and conditions:

1. Assignor and Assignee recognize and acknowledge that Buyer makes no representation or warranty, expressed or implied, that Assignor has any right, title, or interest in the Assigned Agreement(s). Assignee is responsible for satisfying itself as to the existence and extent of Assignor's right, title, and interest in the Assigned Agreement(s) and Assignor and Assignee expressly release Buyer from any liability resulting from or related to this CTA, including assignment for security if any, to which Buyer is consenting herein. Assignee and Assignor further release Buyer from any liability for consenting to any future assignments of the Agreement(s) by Assignee or Assignor.

2. Assignor and Assignee hereby agree that they shall be jointly and severally liable to Buyer for each and every duty and obligation in the Assigned Agreement(s) now the sole responsibility of Assignor. To this end, Assignor shall remain liable and responsible for all such duties and obligations and Assignee hereby agrees to assume each and every such duty and obligation, including, but not limited to, satisfying the Collateral Requirements in the Assigned Agreements.

**RENEWABLE MARKET ADJUSTING TARIFF
POWER PURCHASE AGREEMENT
APPENDIX K – FORM OF GENERAL CONSENT TO
ASSIGNMENT**

3. Assignor and Assignee hereby agree that they shall hold Buyer harmless from, and be jointly and severally liable to Buyer for, any third-party claims, losses, liabilities, damages, costs or expenses (including, without limitation, any direct, indirect or consequential claims, losses, liabilities, damages, costs or expenses, including legal fees) in connection with or arising out of any of the transactions contemplated by the assignment or this CTA.

4. Assignee acknowledges that the assignment of rights to it may be subject to previous assignments, liens or claims executed or arising prior to the Effective Date. Assignee agrees that it takes this assignment subject to any defenses or causes of action Buyer may have against Assignor.

5. Assignee hereby agrees that it will not assign any of the rights, title or interest in, or the duties and obligations under the Assigned Agreement(s) without the prior written consent of Buyer, unless otherwise specifically provided under the Assigned Agreement(s). Assignee further agrees that, in the event of any future assignment, Assignee shall remain jointly and severally liable to Buyer for each and every assigned duty and obligation under said Assigned Agreement(s).

6. Assignor hereby requests that Buyer (i) henceforth make any payments which shall become due under the Assigned Agreement(s) to Assignee and (ii) substitute Assignee for Assignor as the notice addressee under the Assigned Agreement(s). Assignor releases Buyer from all liability for making payment to Assignee, and Assignee releases Buyer from all liability for failure to direct such payments to Assignee rather than Assignor.

7. All notices hereunder shall be in writing and shall be effective when received; for purposes of this CTA, notices shall be deemed received (i) at the close of business on the date of receipt, if delivered by hand, or (ii) at the time and on the date of receipt of a facsimile, or (iii) when signed for by recipient, if sent via registered or certified mail, postage prepaid, or via courier; provided that, such notice was properly addressed to the appropriate address indicated on the signature page hereof or to such other address as a Party may designate by prior written notice to the other Parties.

8. Assignee and Assignor each agree that Buyer shall have (and Buyer hereby expressly reserves) the right to set off or deduct from payments due to Assignor, each and every amount due Buyer from Assignor arising out of or in connection with the Assigned Agreements in accordance with the terms of such Assigned Agreements or in accordance with applicable law. Assignee further agrees that it takes this assignment subject to any defenses or causes of action Buyer may have against Assignor.



**RENEWABLE MARKET ADJUSTING TARIFF
POWER PURCHASE AGREEMENT
APPENDIX K – FORM OF GENERAL CONSENT TO
ASSIGNMENT**

9. Assignee and Assignor agree that any change in payment notification will become effective within 30 days receipt of written notice.

10. Other than as explicitly provided herein, this CTA is neither a modification of nor an amendment to the Assigned Agreement(s).

11. The Parties hereto agree that this CTA shall be construed and interpreted in accordance with the laws of the State of California, excluding any choice of law rules which may direct the application of the laws of another jurisdiction.

12. No term, covenant or condition hereof shall be deemed waived and no breach excused unless such waiver or excuse shall be in writing and signed by the Party claimed to have so waived or excused.

[BUYER]
[Buyer address]

Assignee:
[Enter Assignee Address]

Attn: *[Enter title]* _____

[BUYER],
a California corporation

By: _____

Name: _____

Title: _____

Dated: _____

[Enter Assignee company name], [Enter type of company]

By: _____

Name: _____

Title: _____

Dated: _____



**RENEWABLE MARKET ADJUSTING TARIFF
POWER PURCHASE AGREEMENT
APPENDIX K – FORM OF GENERAL CONSENT TO
ASSIGNMENT**

Assignor:

[Counterparty],[Enter type of company]

*[Mailing_Street_Address]
[Mailing_City], [Mailing_State]
[Mailing_Zip_code]*

By: _____

Name: _____

Title: _____

Dated: _____

Attn: *[Enter title]* _____

**RENEWABLE MARKET ADJUSTING TARIFF
POWER PURCHASE AGREEMENT
APPENDIX L – FORM OF FINANCING CONSENT TO
ASSIGNMENT**

Appendix L – Form of Financing Consent to Assignment

CONSENT AND AGREEMENT

This CONSENT AND AGREEMENT (“Consent and Agreement”) is entered into as of [_____, 2___], between Pacific Gas and Electric Company (“Buyer”), and [_____] , as collateral agent (in such capacity, “Financing Provider”), for the benefit of various financial institutions (collectively, the “Secured Parties”) providing financing to [_____] (“Seller”). Buyer, Seller, and the Financing Provider shall each individually be referred to a “Party” and collectively as the “Parties.”

Recitals

- A. Pursuant to that certain Power Purchase Agreement dated as of _____, 2___ (as amended, modified, supplemented or restated from time to time, as including all related agreements, instruments and documents, collectively, the “Assigned Agreement”) between Buyer and Seller, Buyer has agreed to purchase energy from Seller.
- B. The Secured Parties have provided, or have agreed to provide, to Seller financing (including a financing lease) pursuant to one or more agreements (the “Financing Documents”), and require that Financing Provider be provided certain rights with respect to the “Assigned Agreement” and the “Assigned Agreement Accounts,” each as defined below, in connection with such financing.
- C. In consideration for the execution and delivery of the Assigned Agreement, Buyer has agreed to enter into this Consent and Agreement for the benefit of Seller.

Agreement

1. **Definitions.** Any capitalized term used but not defined herein shall have the meaning specified for such term in the Assigned Agreement.
2. **Consent.** Subject to the terms and conditions below, Buyer consents to and approves the pledge and assignment by Seller to Financing Provider pursuant to the Financing Documents of (a) the Assigned Agreement, and (b) the accounts, revenues

**RENEWABLE MARKET ADJUSTING TARIFF
POWER PURCHASE AGREEMENT
APPENDIX L – FORM OF FINANCING CONSENT TO
ASSIGNMENT**

and proceeds of the Assigned Agreement (collectively, the “Assigned Agreement Accounts”).

3. Limitations on Assignment. Financing Provider acknowledges and confirms that, notwithstanding any provision to the contrary under applicable law or in any Financing Document executed by Seller, Financing Provider shall not assume, sell or otherwise dispose of the Assigned Agreement (whether by foreclosure sale, conveyance in lieu of foreclosure or otherwise) unless, on or before the date of any such assumption, sale or disposition, Financing Provider or any third party, as the case may be, assuming, purchasing or otherwise acquiring the Assigned Agreement (a) cures any and all defaults of Seller under the Assigned Agreement which are capable of being cured and which are not personal to the Seller, (b) executes and delivers to Buyer a written assumption of all of Seller’s rights and obligations under the Assigned Agreement in form and substance reasonably satisfactory to Buyer, (c) otherwise satisfies and complies with all requirements of the Assigned Agreement, (d) provides such tax and enforceability assurance as Buyer may reasonably request, and (e) is a Permitted Transferee (as defined below). Financing Provider further acknowledges that the assignment of the Assigned Agreement and the Assigned Agreement Accounts is for security purposes only and that Financing Provider has no rights under the Assigned Agreement or the Assigned Agreement Accounts to enforce the provisions of the Assigned Agreement or the Assigned Agreement Accounts unless and until an event of default has occurred and is continuing under the Financing Documents between Seller and Financing Provider (a “Financing Default”), in which case Financing Provider shall be entitled to all of the rights and benefits and subject to all of the obligations which Seller then has or may have under the Assigned Agreement to the same extent and in the same manner as if Financing Provider were an original party to the Assigned Agreement.

“Permitted Transferee” means any person or entity who is reasonably acceptable to Buyer. Financing Provider may from time to time, following the occurrence of a Financing Default, notify Buyer in writing of the identity of a proposed transferee of the Assigned Agreement, which proposed transferee may include Financing Provider, in connection with the enforcement of Financing Provider’s rights under the Financing Documents, and Buyer shall, within thirty (30) business days of its receipt of such written notice, confirm to Financing Provider whether or not such proposed transferee is a “Permitted Transferee” (together with a written statement of the reason(s) for any negative determination) it being understood that if Buyer shall fail to so respond within such thirty (30) business day period such proposed transferee shall be deemed to be a “Permitted Transferee”.

4. Cure Rights.

(a) Notice to Financing Provider by Buyer. Buyer shall, concurrently with the delivery of any notice of an event of default under the Assigned Agreement (each, an

**RENEWABLE MARKET ADJUSTING TARIFF
POWER PURCHASE AGREEMENT
APPENDIX L – FORM OF FINANCING CONSENT TO
ASSIGNMENT**

“Event of Default”) to Seller (a “Default Notice”), provide a copy of such Default Notice to Financing Provider pursuant to Section 9(a) of this Consent and Agreement. In addition, Seller shall provide a copy of the Default Notice to Financing Provider the next business day after receipt from Buyer, independent of any agreement of Buyer to deliver such Default Notice.

(b) Cure Period Available to Financing Provider Prior to Any Termination by Buyer. Upon the occurrence of an Event of Default, subject to (i) the expiration of the relevant cure periods provided to Seller under the Assigned Agreement, and (ii) Section 4(a) above, Buyer shall not terminate the Assigned Agreement unless it or Seller provides Financing Provider with notice of the Event of Default and affords Financing Provider an Additional Cure Period (as defined below) to cure such Event of Default. For purposes of this Agreement “Additional Cure Period” means (i) with respect to a monetary default, ten (10) days in addition to the cure period (if any) provided to Seller in the Assigned Agreement, and (ii) with respect to a non-monetary default, thirty (30) days in addition to the cure period (if any) provided to Seller in the Assigned Agreement.

(c) Failure by Buyer to Deliver Default Notice. If neither Buyer nor Seller delivers a Default Notice to Financing Provider as provided in Section 4(a), the Financing Provider’s applicable cure period shall begin on the date on which notice of an Event of Default is delivered to Financing Provider by either Buyer or Seller. Except for a delay in the commencement of the cure period for Financing Provider and a delay in Buyer’s ability to terminate the Assigned Agreement (in each case only if both Buyer and Seller fail to deliver notice of an Event of Default to Financing Provider), failure of Buyer to deliver any Default Notice shall not waive Buyer’s right to take any action under the Assigned Agreement and will not subject Buyer to any damages or liability for failure to provide such notice.

(d) Extension for Foreclosure Proceedings. If possession of the Project (as defined in the Assigned Agreement) is necessary for Financing Provider to cure an Event of Default and Financing Provider commences foreclosure proceedings against Seller within thirty (30) days of receiving notice of an Event of Default from Buyer or Seller, whichever is received first, Financing Provider shall be allowed a reasonable additional period to complete such foreclosure proceedings, such period not to exceed ninety (90) days; provided, however, that Financing Provider shall provide a written notice to Buyer that it intends to commence foreclosure proceedings with respect to Seller within ten (10) business days of receiving a notice of such Event of Default from Buyer or Seller, whichever is received first. In the event Financing Provider succeeds to Seller’s interest in the Project as a result of foreclosure proceedings, the Financing Provider or a purchaser or grantee pursuant to such foreclosure shall be subject to the requirements of Section 3 of this Consent and Agreement.

5. Setoffs and Deductions. Each of Seller and Financing Provider agrees that Buyer shall have the right to set off or deduct from payments due to Seller each and

**RENEWABLE MARKET ADJUSTING TARIFF
POWER PURCHASE AGREEMENT**
**APPENDIX L – FORM OF FINANCING CONSENT TO
ASSIGNMENT**

every amount due Buyer from Seller whether or not arising out of or in connection with the Assigned Agreement. Financing Provider further agrees that it takes the assignment for security purposes of the Assigned Agreement and the Assigned Agreement Accounts subject to any defenses or causes of action Buyer may have against Seller.

6. No Representation or Warranty. Seller and Financing Provider each recognizes and acknowledges that Buyer makes no representation or warranty, express or implied, that Seller has any right, title, or interest in the Assigned Agreement or as to the priority of the assignment for security purposes of the Assigned Agreement or the Assigned Agreement Accounts. Financing Provider is responsible for satisfying itself as to the existence and extent of Seller's right, title, and interest in the Assigned Agreement, and Financing Provider releases Buyer from any liability resulting from the assignment for security purposes of the Assigned Agreement and the Assigned Agreement Accounts.

7. Amendment to Assigned Agreement. Financing Provider acknowledges and agrees that Buyer may agree with Seller to modify or amend the Assigned Agreement, and that Buyer is not obligated to notify Financing Provider of any such amendment or modification to the Assigned Agreement. Financing Provider hereby releases Buyer from all liability arising out of or in connection with the making of any amendment or modification to the Assigned Agreement.

8. Payments under Assigned Agreement. Buyer shall make all payments due to Seller under the Assigned Agreement from and after the date hereof to [_____], as depository agent, to ABA No. [_____], Account No. [_____], and Seller hereby irrevocably consents to any and all such payments being made in such manner. Each of Seller, Buyer and Financing Provider agrees that each such payment by Buyer to such depository agent of amounts due to Seller from Buyer under the Assigned Agreement shall satisfy Buyer's corresponding payment obligation under the Assigned Agreement.

9. Miscellaneous.

(a) Notices. All notices hereunder shall be in writing and shall be deemed received (i) at the close of business of the date of receipt, if delivered by hand or by facsimile or other electronic means, or (ii) when signed for by recipient, if sent registered or certified mail, postage prepaid, provided such notice was properly addressed to the appropriate address indicated on the signature page hereof or to such other address as a party may designate by prior written notice to the other parties, at the address set forth below:

**RENEWABLE MARKET ADJUSTING TARIFF
POWER PURCHASE AGREEMENT
APPENDIX L – FORM OF FINANCING CONSENT TO
ASSIGNMENT**

If to Financing Provider:	
Name:	
Address:	
Attn:	
Telephone:	
Facsimile:	
Email:	

If to Buyer:	
Name:	
Address:	
Attn:	
Telephone:	
Facsimile:	
Email:	

(b) No Assignment. This Consent and Agreement shall be binding upon and shall inure to the benefit of the successors and assigns of Buyer, and shall be binding on and inure to the benefit of the Financing Provider, the Secured Parties and their respective successors and permitted transferees and assigns under the loan agreement and/or security agreement.

(c) No Modification. This Consent and Agreement is neither a modification of nor an amendment to the Assigned Agreement.

(d) Choice of Law. The parties hereto agree that this Consent and Agreement shall be construed and interpreted in accordance with the laws of the State of California, excluding any choice of law rules which may direct the application of the laws of another jurisdiction.

(e) No Waiver. No term, covenant or condition hereof shall be deemed waived and no breach excused unless such waiver or excuse shall be in writing and signed by the party claimed to have so waived or excused.



**RENEWABLE MARKET ADJUSTING TARIFF
POWER PURCHASE AGREEMENT
APPENDIX L – FORM OF FINANCING CONSENT TO
ASSIGNMENT**

(f) Counterparts. This Consent and Agreement may be executed in one or more duplicate counterparts, and when executed and delivered by all the parties listed below, shall constitute a single binding agreement.

(g) No Third Party Beneficiaries. There are no third party beneficiaries to this Consent and Agreement.

(h) Severability. The invalidity or unenforceability of any provision of this Consent and Agreement shall not affect the validity or enforceability of any other provision of this Consent and Agreement, which shall remain in full force and effect.

(i) Amendments. This Consent and Agreement may be modified, amended, or rescinded only by writing expressly referring to this Consent and Agreement and signed by all parties hereto.

IN WITNESS WHEREOF, each of Buyer and Financing Provider has duly executed this Consent and Agreement as of the date first written above.

PACIFIC GAS AND ELECTRIC COMPANY

(Buyer)

(Signature)

(Type/Print Name)

(Title)

(Date)

(Financing Provider), as collateral agent

(Signature)

(Type/Print Name)

(Title)

(Date)

**RENEWABLE MARKET ADJUSTING TARIFF
POWER PURCHASE AGREEMENT
APPENDIX L – FORM OF FINANCING CONSENT TO
ASSIGNMENT**

ACKNOWLEDGEMENT

The undersigned hereby acknowledges the Consent and Agreement set forth above, makes the agreements set forth therein as applicable to Seller, including the obligation of Seller to provide a copy of any Default Notice it receives from Buyer to Financing Provider the next business day after receipt by Seller, and confirms that the Financing Provider identified above and the Secured Parties have provided or are providing financing to the undersigned.

(Name of Seller)

(Signature)

(Type/Print Name)

(Title)

(Date)

*** End of Appendix L ***

**RENEWABLE MARKET ADJUSTING TARIFF
POWER PURCHASE AGREEMENT
APPENDIX M – PROCEDURE FOR
DEMONSTRATION OF CONTRACT CAPACITY**

Appendix M - Procedure for Demonstration of Contract Capacity

1. Seller's Notice of Demonstration Date.

Seller shall provide at least thirty (30) days prior Notice to Buyer of the date selected by Seller ("Demonstration Date") during which Seller intends to demonstrate the Contract Capacity. Upon Buyer's request, Seller shall make reasonable efforts to reschedule the Demonstration Date.

[for solar photovoltaic and wind technologies]

Seller's Notice of Demonstration Hour.

Seller shall provide Notice to Buyer of the date and hour selected by Seller during which Seller claims it has demonstrated the applicable Contract Capacity ("Demonstration Hour").

[for technologies other than solar photovoltaic and wind]

2. Demonstration of Contract Capacity.

Subject to Section 4 of this Appendix M, Buyer shall complete a Site visit on the Demonstration Date to verify that the Facility was developed in accordance with the Facility and Site description set forth in Appendix E and to determine the Demonstrated Contract Capacity [and Installed DC Rating *[solar photovoltaic technology]*].

[for solar photovoltaic and wind technologies]

Demonstration of Contract Capacity.

- (a) Unless Buyer provides timely Notice to Seller that additional days are required to substantiate data, Buyer shall, within thirty (30) days after Seller's Notice of the Demonstration Hour, retrieve interval data downloaded from the meter specified in Section 6.2.1 or Check Meter, as applicable, for the twelve (12) hour periods before and after the Demonstration Hour; and
- (b) Buyer may, at its sole discretion, complete a Site visit within thirty (30) days after Buyer's receipt of Seller's Notice of the Demonstration Hour to verify that the Facility was developed in accordance with the Facility and Site description set forth in Appendix E. *[for technologies other than solar photovoltaic and wind]*

**RENEWABLE MARKET ADJUSTING TARIFF
POWER PURCHASE AGREEMENT
APPENDIX M – PROCEDURE FOR
DEMONSTRATION OF CONTRACT CAPACITY**

3. Demonstrated Contract Capacity.

Unless Buyer provides timely Notice to Seller that additional days are required to substantiate data, Buyer shall within ten (10) Business Days after Buyer's Site visit pursuant to Section 2 of this Appendix M provide Notice to Seller of the amount of the Demonstrated Contract Capacity.

4. Buyer's Election of Demonstration Method.

Notwithstanding the foregoing, Buyer may, in its sole discretion, (a) require that Seller, at its own cost, provide a certified statement from a Licensed Professional Engineer verifying that the Facility was developed in accordance with the Facility and Site description set forth in Appendix E and setting forth the Demonstrated Contract Capacity determined in accordance with this Appendix M as of the date of the certification (an "Engineer Report") or (b) waive the requirement to demonstrate the Contract Capacity.

In the event that the Buyer waives demonstration of the Contract Capacity, the Demonstrated Contract Capacity will be deemed to be equal to the Contract Capacity specified in Section 3.1 of the Agreement.

*** *End of Appendix M* ***



RENEWABLE MARKET ADJUSTING TARIFF POWER PURCHASE AGREEMENT

APPENDIX N-1 – QF EFFICIENCY MONITORING PROGRAM – COGENERATION DATA REPORTING FORM

Appendix N-1 - QF Efficiency Monitoring Program – Cogeneration Data Reporting Form

[PrevYear]

I. Name and Address of Project

Name: _____
 Street: _____
 City: _____ State: _____ Zip Code: _____
 ID No.: _____ Generation Nameplate (KW): _____

II. In Operation: Yes No

III. Can your facility dump your thermal output directly to the environment? Yes No

IV. Ownership

	Name	Address	Ownership (%)	Utility
1	_____	_____	Y	N
2	_____	_____	Y	N
3	_____	_____	Y	N
4	_____	_____	Y	N
5	_____	_____	Y	N

V. [PrevYear] Monthly Operating Data

- Indicate the unit of measure used for your Useful Thermal Energy Output if other than mBTUs:

BTUs _____ Therms _____ mMBTUs _____

If Energy Input is natural gas, use the Lower Heating Value (LHV) as supplied by Gas Supplier.

	Useful Power Output (1) (kWh)	Energy Input (Therms)	Useful Thermal Energy Output (mBtu)
Jan			
Feb			
Mar			
Apr			
May			
Jun			
Jul			
Aug			
Sep			
Oct			
Nov			
Dec			
Yearly Total			

(1) Useful Power Output is the electric or mechanical energy made available for use from the facility.

*** End of Appendix N-1 ***



**RENEWABLE MARKET ADJUSTING TARIFF
POWER PURCHASE AGREEMENT
APPENDIX N-2 – FUEL USE STANDARDS – SMALL
POWER PRODUCER DATA REPORTING FORM**

**Appendix N-2 - Fuel Use Standards – Small Power Producer Data
Reporting Form**

[Prev Year]; ID No. _____

I. Name and Address of Facility (“Project”)

Name: _____

Street: _____

City: _____ State: _____ Zip Code: _____

Generation Nameplate (KW): _____

II. Primary Energy: Biomass Waste Solar Other: _____

III. Ownership

	Name	Address	Ownership (%)	Utility
1	_____	_____	_____	Y N
2	_____	_____	_____	Y N
3	_____	_____	_____	Y N
4	_____	_____	_____	Y N
5	_____	_____	_____	Y N

IV. [Prev Year] Monthly Operating Data

	Useful Power Output (1) (kWh)	Primary Energy Source (2) (mBTU)	Supplementary Energy Source (3) (mBTU)	Total Energy Input (4) (mBTU)
Jan				
Feb				
Mar				
Apr				
May				
Jun				
Jul				
Aug				
Sep				
Oct				
Nov				
Dec				
Total				

- (1) Useful Power Output is the electric or mechanical energy made available for use from the facility.
- (2) The Primary Energy Source must be biomass, waste, renewable resources, or geothermal resources. Use Lower Heating Value (LHV)
- (3) The Supplementary Energy Source is the use of fossil fuel. Use Lower Heating Value (LHV)
- (4) Please use Total Energy Input to include all energy sources: primary, supplementary, and auxiliary power from outside the facility.

*** End of Appendix N-2 ***



**RENEWABLE MARKET ADJUSTING TARIFF
POWER PURCHASE AGREEMENT
APPENDIX N-2 – FUEL USE STANDARDS – SMALL
POWER PRODUCER DATA REPORTING FORM**
