



**RENEWABLE POWER PURCHASE AGREEMENT**

*between*

**SOUTHERN CALIFORNIA EDISON COMPANY**

*and*

**PACIFIC ULTRAPOWER CHINESE STATION (RAP ID #1242)**

**TABLE OF CONTENTS**

**PREAMBLE AND RECITALS** ..... 1

**ARTICLE ONE. SPECIAL CONDITIONS** ..... 2

    1.01 Generating Facility.....2

    1.02 Forecasted Commercial Operation Date.....2

    1.03 Commercial Operation Deadline.....2

    1.04 Term.....3

    1.05 Product Price.....3

    1.06 Performance Assurance Amount.....4

    1.07 Interconnection Queue Position.....4

    1.08 Compliance Expenditure Cap.....4

**ARTICLE TWO. TERM AND CONDITIONS PRECEDENT; TERMINATION** ..... 6

    2.01 Obligations Prior to Commencement of the Term.....6

    2.02 Conditions Precedent to Commencement of Term.....6

    2.03 Termination Rights.....7

    2.04 Rights and Obligations Surviving Termination.....8

**ARTICLE THREE. SELLER’S OBLIGATIONS** ..... 11

    3.01 Conveyance of Entire Output, Conveyance of Green Attributes, Capacity Attributes and Resource Adequacy Benefits.....11

    3.02 Resource Adequacy Performance Obligation.....12

    3.03 Other Sales of Product.....13

    3.04 Allocation of Availability Incentive Payments and Non-Availability Charges.....13

    3.05 Permits, Interconnection and Transmission Service Agreements, and CAISO Tariff Compliance.....13

    3.06 Development Security.....13

    3.07 Seller’s Energy Delivery Obligation.....17

    3.08 Metering, Communications, Telemetry and Meteorological Station(s).....18

    3.09 Site Location and Control.....21

    3.10 Change in Structure, Ownership or Financing.....21

    3.11 Design.....21

    3.12 Operation and Record Keeping.....22

    3.13 Obtaining Scheduling Coordinator Services.....24

    3.14 Forecasting.....25

    3.15 Scheduled Outages.....25

    3.16 Progress Reporting Toward Meeting Milestone Schedule.....26

    3.17 [Intentionally Deleted.].....26

    3.18 Provision of Information.....26

    3.19 SCE’s Access Rights.....28

    3.20 Obtaining and Maintaining CEC Certification, and CEC Verification.....28

    3.21 Notice of Cessation or Termination of Service Agreements.....29

    3.22 Lost Output Report.....29

*The contents of this document are subject to restrictions on disclosure as set forth herein.*

3.23 Actual Availability Report.....30

3.24 [Intentionally Deleted.].....30

3.25 [Intentionally Deleted.].....30

3.26 [Intentionally Deleted.].....30

3.27 NERC Reliability Standards. ....30

3.28 Application of Prevailing Wage.....31

**ARTICLE FOUR. SCE’S OBLIGATIONS..... 32**

4.01 Obligation to Pay and Invoice.....32

4.02 SCE’s Check Meter.....32

4.03 Scheduling Coordinator. ....33

4.04 Termination of Scheduling Coordinator. ....33

4.05 Exclusive Rights to Product and Cost Responsibility.....33

4.06 Interest Payments on Cash Deposits. ....33

**ARTICLE FIVE. FORCE MAJEURE ..... 35**

5.01 No Default for Force Majeure.....35

5.02 Requirements Applicable to the Claiming Party. ....35

5.03 Commercial Operation Deadline Extension. ....35

5.04 Termination.....36

**ARTICLE SIX. EVENTS OF DEFAULT; REMEDIES ..... 37**

6.01 Events of Default. ....37

6.02 Early Termination. ....40

6.03 Termination Payment.....40

**ARTICLE SEVEN. LIMITATIONS OF LIABILITIES..... 42**

**ARTICLE EIGHT. CREDIT AND COLLATERAL REQUIREMENTS ..... 43**

8.01 Financial Information.....43

8.02 Development Security and Performance Assurance.....43

8.03 First Priority Security Interest in Cash or Cash Equivalent Collateral. ....46

8.04 Credit and Collateral Covenants. ....46

8.05 Commercial Code Waiver.....47

8.06 Consolidation of Seller’s Financial Statements.....48

**ARTICLE NINE. GOVERNMENTAL CHARGES..... 51**

9.01 Cooperation to Minimize Tax Liabilities.....51

9.02 Governmental Charges.....51

9.03 Providing Information to Taxing Authorities. ....51

**ARTICLE TEN. MISCELLANEOUS ..... 52**

10.01 Representations and Warranties.....52

10.02 Additional Seller Representations, Warranties and Covenants. ....52

10.03 Indemnity. ....54

10.04 Assignment. ....56

10.05 Consent to Collateral Assignment. ....56

10.06 Abandonment.....58

*The contents of this document are subject to restrictions on disclosure as set forth herein.*

10.07 Governing Law. ....58  
10.08 Notices. ....58  
10.09 General. ....59  
10.10 Confidentiality. ....60  
10.11 Insurance. ....63  
10.12 Nondedication. ....66  
10.13 Mobile Sierra. ....67  
10.14 Simple Interest Payments.....67  
10.15 Payments. ....67  
10.16 Seller Ownership and Control of Generating Facility. ....67  
10.17 Required Material. ....67

**ARTICLE ELEVEN. CHANGE IN ELECTRIC MARKET DESIGN ..... 69**

**ARTICLE TWELVE. MEDIATION AND ARBITRATION ..... 70**

12.01 Dispute Resolution.....70  
12.02 Mediation. ....70  
12.03 Arbitration.....71  
12.04 Provisional Relief.....73

**SIGNATURES**

## LIST OF EXHIBITS

- A. Definitions.
- B. Generating Facility and Site Description.
- C. Notice List.
- D. Forecasting and Scheduling Requirements and Procedures.
- E. Payments and Invoicing.
- F. Product Replacement Damage Amount.
- G. Seller's Milestone Schedule and Material Permits.
- H. Milestone Progress Reporting Form.
- I. Time of Delivery Periods and Product Payment Allocation Factors.
- J. Procedure for Demonstration of Contract Capacity and Partial or Full Return of Development Security.
- K. Seller's Estimate of Lost Output.
- L. Form of Letter of Credit.
- M. CAISO Costs and CAISO Sanctions.
- N. Actual Availability Report.
- O. [Intentionally Deleted.]

## RENEWABLE POWER PURCHASE AGREEMENT

between

**SOUTHERN CALIFORNIA EDISON COMPANY**

and

**PACIFIC ULTRAPOWER CHINESE STATION**

**(RAP ID # 1242)**

### PREAMBLE

This Renewable Power Purchase Agreement, together with the exhibits and attachments (collectively, the “Agreement”) is made and effective as of the following date: October 18, 2016 (“Effective Date”).

This Agreement is entered into between:

- (i) **Southern California Edison Company** (“SCE”), a California corporation, whose principal place of business is at 2244 Walnut Grove Avenue, Rosemead, California 91770, and
- (ii) **Pacific Ultrapower Chinese Station** (“Seller”), a California General Partnership, whose principal place of business is at 8755 Enterprise Drive, Jamestown, California 95327.

SCE and Seller are sometimes referred to herein individually as a “Party” and jointly as the “Parties.” Unless the context otherwise specifies or requires, capitalized terms in this Agreement have the meanings set forth in Exhibit A.

### RECITALS

- A. Seller is willing to own, and Operate a Generating Facility which qualifies, or will qualify, as an ERR, and to sell the Product to SCE pursuant to the terms and conditions set forth in this Agreement; and
- B. SCE is willing to purchase the Product from Seller pursuant to the terms and conditions set forth in this Agreement.

## ARTICLE ONE. SPECIAL CONDITIONS

### 1.01 Generating Facility.

- (a) Name: Pacific Ultrapower Chinese Station
- (b) Location of Site: 8755 Enterprise Drive, Jamestown, California 95327, as further described in Exhibit B.
- (c) Description: As set forth in Exhibit B.
- (d) Product: All electric energy produced by the Generating Facility throughout the Delivery Term, net of Station Use; all Green Attributes; all Capacity Attributes; and all Resource Adequacy Benefits; generated by, associated with or attributable to the Generating Facility throughout the Delivery Term.
- (e) Interconnection Point: Pacific Ultrapower Chinese Station Tap, New Melones 115kV Line
- (f) Delivery Point: At the point of interconnection with the CAISO-Controlled Grid, New Melones 115Kv (Cal-ISO Resource ID ULTPCH\_1\_UNIT).
- (g) ERR Type: Biomass.
- (h) Contract Capacity: 18 MW.

The Contract Capacity may be reduced as set forth in Section 3.06(g).

- (i) [Intentionally Deleted.]
- (j) Expected Annual Net Energy Production.

The Expected Annual Net Energy Production for each Term Year will be the value calculated in accordance with the following formula:

EXPECTED ANNUAL NET ENERGY PRODUCTION, in kWh = A x B x C

Where:

- A = Contract Capacity in kW.
- B = 82% capacity factor.
- C = 8,760 hours per year.

### 1.02 Forecasted Commercial Operation Date.

The Forecasted Commercial Operation Date is March 1, 2017.

### 1.03 Commercial Operation Deadline.

- (a) Subject to any extensions made pursuant to Sections 3.06(c) or 5.03, and further subject to Section 1.03(c), the Commercial Operation Date must be no later than [N/A] (“Commercial Operation Deadline”).

*The contents of this document are subject to restrictions on disclosure as set forth herein.*

- (b) Subject to Section 1.03(d), if Seller has not obtained Permit Approval on or before that date that is ninety (90) days before the date that is twenty-four (24) months from the date of CPUC Approval, then, upon SCE's receipt of Notice from Seller, which Notice must be provided at least sixty (60) days before the date that is twenty-four (24) months from the date of CPUC Approval, the Commercial Operation Deadline shall be extended six (6) months from the date that is twenty-four (24) months from the date of CPUC Approval; provided, however, such extension shall not be given if the failure to obtain Permit Approval was as a result of Seller's failure to take all commercially reasonable actions to apply for and meet all of its requirements and deadlines to obtain such Permit Approval.
- (c) Notwithstanding anything in this Agreement to the contrary, the Commercial Operation Deadline may not be later than the date that is forty-two months from the date of CPUC Approval.
- (d) Upon request from SCE, Seller shall provide documentation demonstrating to SCE's reasonable satisfaction that the delays described in Section 1.03(b), did not result from Seller's action or failure to take action as described in Section 1.03(b).

## 1.04 Term.

- (a) The Term commences on the Commercial Operation Date determined in accordance with Section 2.02 and ends on the last day of the calendar month that is [N/A] months from the month of the Commercial Operation Date (the "Term").

## 1.05 Product Price.

- (a) Subject to Sections 1.05(b) and 1.05(c)(i), the Product Price is [N/A] dollars per MWh.
- (b) [Intentionally Deleted.]
- (c) Excess Deliveries.
  - (i) If during any Settlement Interval Seller delivers Metered Amounts, expressed in MWh, in excess of the product of the Contract Capacity, expressed in MW, multiplied by the length of such Settlement Interval, expressed in hours, then the Product Price applicable to all such excess MWh in such Settlement Interval shall be Zero dollars (\$0) per MWh, and if there is a Negative LMP during such Settlement Interval, Seller shall pay to SCE an amount equal to the absolute value of the Negative LMP times such excess MWh ("Negative LMP Costs").
  - (ii) If during any Term Year Seller delivers Metered Amounts, together with Curtailed Product, that are in the aggregate in excess of one hundred fifteen percent (115%) of the Expected Annual Net Energy Production for such Term Year and such Metered Amounts are not (1) subject to Section 1.05(c)(i) or (2) delivered in violation of Section 3.12(g), then Seller shall



be responsible for and pay all CAISO Sanctions and CAISO Costs and Seller shall be entitled to all CAISO Revenues with respect to all such excess Metered Amounts in such Term Year.

1.06 Performance Assurance Amount.

Commencing with the Commercial Operation Date and for every Term Year during the Term, Seller shall post and maintain Performance Assurance in the amount of Four Million Four Hundred Eighty Thousand dollars (\$4,480,000.00).

1.07 Interconnection Queue Position.

N/A

1.08 Compliance Expenditure Cap.

If Seller establishes to SCE's reasonable satisfaction that a change in Applicable Laws occurring after the Effective Date has increased Seller's cost above the cost that could reasonably have been contemplated as of the Effective Date to take all actions to comply with Seller's obligations under the Agreement with respect to obtaining, maintaining, conveying or effectuating SCE's use of (as applicable), the items listed in Sections 1.11(a) through (d), then Seller's required out-of-pocket expenses are limited to One Hundred Fifty-One Thousand dollars (\$151,000.00 ) in the aggregate each Term Year ("Compliance Expenditure Cap") between the Effective Date and the last day of the Term:

- (a) CEC Pre-Certification or CEC Certification and CEC Verification;
- (b) Green Attributes;
- (c) Capacity Attributes; and
- (d) Resource Adequacy Benefits.

Any actions required for Seller to comply with its obligations set forth in the first paragraph above, the cost of which will be included in the Compliance Expenditure Cap, shall be referred to collectively as the "Compliance Actions."

If Seller reasonably anticipates the need to incur out-of-pocket expenses in excess of the Compliance Expenditure Cap in order to take any Compliance Action Seller shall provide Notice to SCE of such anticipated out-of-pocket expenses.

SCE will have sixty (60) days to evaluate such Notice (during which time period Seller is not obligated to take any Compliance Actions described in the Notice) and shall, within such time, either (1) agree to reimburse Seller for all or some portion of the costs that exceed the Compliance Expenditure Cap (such SCE-agreed upon costs, the "Accepted Compliance Costs"), or (2) waive Seller's obligation to take such Compliance Actions, or any part thereof for which SCE has not agreed to reimburse Seller.

If SCE agrees to reimburse Seller for the Accepted Compliance Costs, then Seller shall take such Compliance Actions covered by the Accepted Compliance Costs as agreed

*RAP ID #1242, Pacific Ultrapower Chinese Station*

upon by the Parties and SCE shall reimburse Seller for Seller's actual costs to effect the Compliance Actions, not to exceed the Accepted Compliance Costs.

---

*\*\*\* End of ARTICLE ONE \*\*\**

*The contents of this document are subject to restrictions on disclosure as set forth herein.*

---

**ARTICLE TWO. TERM AND CONDITIONS PRECEDENT; TERMINATION****2.01 Obligations Prior to Commencement of the Term.****(a) CPUC Filing and Approval of this Agreement.**

Within ninety (90) days after the Effective Date, SCE shall file with the CPUC the appropriate request for CPUC Approval. SCE shall expeditiously seek CPUC Approval, including promptly responding to any requests for information related to the request for CPUC Approval. As requested by SCE, Seller shall use commercially reasonable efforts to support SCE in obtaining CPUC Approval. SCE has no obligation to seek rehearing or to appeal a CPUC decision which fails to approve this Agreement or which contains findings required for CPUC Approval with conditions or modifications unacceptable to either Party.

**(b) Seller's Interconnection Queue Position.**

Seller must not (i) withdraw the Interconnection Queue Position identified in Section 1.07, (ii) assign or transfer that Interconnection Queue Position to any entity, or (iii) utilize the Interconnection Queue Position for the benefit of any power purchase and sale agreement other than the Agreement, in each case, without SCE's prior written consent.

**(c) Seller's Regulatory and Governmental Filings.**

- (i) Within one hundred eighty (180) days after the Effective Date, Seller shall file an application or other appropriate request for CEC Pre-Certification for the Generating Facility.
- (ii) On or before March 1, 2017, Seller shall file all applications or other appropriate requests with the proper authorities for all Material Permits, and shall promptly respond to any requests for information from the requesting authority.

**2.02 Conditions Precedent to Commencement of Term.****(a) Commencement of Term.**

The Term commences upon the Commercial Operation Date.

**(b) Commercial Operation.**

- (i) Subject to the remainder of this subsection 2.02(b), the Commercial Operation Date shall be a date selected by Seller upon at least three (3) Business Days Notice to SCE; *provided*, the Commercial Operation Date may not be earlier than March 1, 2017.
- (ii) The Commercial Operation Date may not occur until each of the following has been satisfied:
  - (1) Seller has completed the installation and testing of the Generating Facility for purposes of financing, Permits, the interconnection

*The contents of this document are subject to restrictions on disclosure as set forth herein.*

agreement, operating agreements, the EPC agreement and manufacturer's warranties;

- (2) Seller has received an independent engineer's certification that the Generating Facility has been completed in all material respects (except punch list items that do not materially and adversely affect the ability of the Generating Facility to operate as intended);
- (3) Seller has met all conditions set forth in Section 3.12(c);
- (4) Seller has posted with SCE the Performance Assurance required under Section 8.02 calculated in accordance with Section 1.06;
- (5) Seller has paid to SCE the full amount of the Excess Network Upgrade Costs, if applicable; and
- (6) Seller has taken all steps necessary to allow SCE to be designated as the Account Holder in accordance with Section 3.01(d)(iv).

## 2.03 Termination Rights.

### (a) Termination Rights of Both Parties.

- (i) If either Party exercises a termination right, as set forth in Sections 2.03(a)(ii), 2.03(b) or 5.04, a Termination Payment will be calculated in accordance with Section 6.03, the Forward Settlement Amount will be Zero dollars (\$0), the terminating Party will be considered the Non-Defaulting Party and, if the termination occurs before the commencement of the Term, Seller will be entitled to a return of any Development Security provided to SCE.
- (ii) Either Party has the right to terminate this Agreement on Notice, which will be effective five (5) Business Days after such Notice is given, if CPUC Approval has not been obtained or waived by SCE in its sole discretion within three hundred sixty-five (365) days after SCE files its request for CPUC Approval and a Notice of termination is given on or before the three hundred ninety-fifth (395th) day after SCE files the request for CPUC Approval.

### (b) Termination Rights of SCE.

SCE has the right to terminate this Agreement on Notice, which will be effective five (5) Business Days after such Notice is given to Seller, on or before the date that is sixty (60) days after Seller provides to SCE the results of any Interconnection Study or the interconnection agreement tendered to Seller by the Transmission Provider if:

- (i) Such Interconnection Study or agreement as of the date of the termination Notice, estimates, includes, specifies or reflects that the maximum total cost of transmission upgrades or new transmission facilities to SCE, or any

*The contents of this document are subject to restrictions on disclosure as set forth herein.*

Transmission Provider under the jurisdiction of the CAISO, including costs reimbursed by SCE, or any Transmission Provider under the jurisdiction of the CAISO, to Seller (“Aggregate Network Upgrade Costs”), may in the aggregate exceed Zero dollars (\$0) (“Network Upgrades Cap”), irrespective of any subsequent amendments of such Interconnection Study or agreement or any contingencies or assumptions upon which such Interconnection Study or agreement is based; or

- (ii) SCE must procure transmission service from any other Transmission Provider to allow SCE to Schedule electric energy from the Generating Facility and the cost for such transmission service is not reimbursed or paid by Seller.

Notwithstanding anything to the contrary in this Section 2.03(b), SCE shall have no right to terminate this Agreement under this Section 2.03(b), if Seller, concurrently with its provision of the relevant Interconnection Study or agreement pursuant to Section 3.17(a), irrevocably agrees that Seller shall owe to SCE (I) the amount by which the Aggregate Network Upgrade Costs exceed the Network Upgrades Cap (“Excess Network Upgrade Costs”), and (II) any costs for transmission services specified in Section 2.03(b)(ii). If Seller elects to pay, without reimbursement, for the Excess Network Upgrade Costs pursuant to this Section 2.03(b), in no event shall Seller have any interest in or rights or title to any Network Upgrades (as defined in the CAISO Tariff) or Congestion Revenue Rights (as defined in the CAISO Tariff) in connection with the development of the Generating Facility or the delivery of Product to SCE pursuant to this Agreement.

- (c) Uncured Defaults.

Upon the occurrence of an Event of Default, the Non-Defaulting Party may terminate this Agreement as set forth in Section 6.02.

- (d) End of Term.

This Agreement automatically terminates at the end of the Term as set forth in Section 1.04 unless earlier terminated as provided in this Agreement.

#### 2.04 Rights and Obligations Surviving Termination.

- (a) Survival of Rights and Obligations Generally.

The rights and obligations that are intended to survive a termination of this Agreement are all of those rights and obligations that this Agreement expressly provides survive any such termination and those that arise from Seller’s or SCE’s covenants, agreements, representations, and warranties applicable to, or to be performed, at or during any time before or as a result of the termination of this Agreement, including:

*The contents of this document are subject to restrictions on disclosure as set forth herein.*

- (i) The obligation of Seller to pay the Product Replacement Damage Amount as set forth in Section 3.07(b);
- (ii) The obligation to make, or the right to receive, a Termination Payment as set forth in Section 6.03;
- (iii) The indemnity obligations as set forth in Section 10.03;
- (iv) The obligation of confidentiality as set forth in Section 10.10;
- (v) The right to pursue remedies as set forth in Sections 6.02 and 12.04;
- (vi) The limitation of liabilities as set forth in Article Seven;
- (vii) A Party's obligation:
  - (1) To make or receive payment, as applicable, for CAISO Revenues and make payment for CAISO Costs, CAISO Sanctions, and SCE Penalties, as applicable, as set forth in Article Four, Exhibits E and N; and
  - (2) To make or receive Product Payments as set forth in Exhibit E;
- (viii) The covenants and indemnifications regarding the limitations on Seller's and Seller's Affiliates' ability to offer, make or agree to third-party sales as set forth in Sections 2.04(b) and 3.06(h), if applicable;
- (ix) The obligation of Seller to pay to SCE the Development Security if SCE terminates this Agreement in accordance with Section 6.02 prior to Commercial Operation;
- (x) The obligation of Seller to post Performance Assurance as set forth in Section 8.02;
- (xi) The dispute resolution provisions of Article Twelve;
- (xii) The obligation of SCE to return any Development Security under Section 3.06 and Performance Assurance under Section 8.02, as applicable;
- (xiii) Seller's obligations under Section 3.01(d)(iv); and
- (xiv) The obligation of Seller to transfer Green Attributes associated with Product, in accordance with Section 3.01(b), for which SCE has paid the Product Price.

(b) Limitations on Seller's and Seller's Affiliates' Ability to Make or Agree to Third-Party Sales from the Site after Certain Terminations of this Agreement.

If Seller terminates this Agreement, as provided in Sections 2.03(a)(ii) or 5.04 (based on a Force Majeure as to which Seller is the Claiming Party), or if SCE terminates this Agreement as provided in Section 3.06(d), or due to an Event of Default of Seller prior to the Commercial Operation Deadline, neither Seller nor

*The contents of this document are subject to restrictions on disclosure as set forth herein.*

Seller's Affiliates may sell, or enter into a contract to sell, electric energy, Green Attributes, Capacity Attributes, or Resource Adequacy Benefits, generated by, associated with or attributable to a generating facility installed at the Site to a party other than SCE for a period of two (2) years following the effective date of such termination (the "Restricted Period").

This prohibition on contracting and sale will not apply if, before entering into such contract or making a sale to a party other than SCE, Seller or Seller's Affiliate provides SCE with a written offer to sell the electric energy, Green Attributes, Capacity Attributes and Resource Adequacy Benefits to SCE at the Product Price and on other terms and conditions materially similar to the terms and conditions contained in this Agreement and SCE fails to accept such offer within forty-five (45) days after SCE's receipt thereof.

Neither Seller nor Seller's Affiliates may sell or transfer the Generating Facility, or any part thereof, or land rights or interests in the Site (including the Interconnection Queue Position) during the Restricted Period so long as the limitations contained in this Section 2.04(b) apply, unless the transferee agrees to be bound by the terms set forth in this Section 2.04(b) pursuant to a written agreement approved by SCE. Upon termination of this Agreement pursuant to the Sections referenced in the first paragraph of this Section 2.04(b), Seller shall deliver a notice of SCE's rights in respect of the Site, in a form reasonably acceptable to SCE, that SCE may record giving notice of SCE's rights under this Section 2.04(b).

Seller shall indemnify and hold SCE harmless from all benefits lost and other damages sustained by SCE as a result of any breach of the covenants contained within this Section 2.04(b).

---

\*\*\* *End of ARTICLE TWO* \*\*\*

**ARTICLE THREE. SELLER'S OBLIGATIONS****3.01 Conveyance of Entire Output, Conveyance of Green Attributes, Capacity Attributes and Resource Adequacy Benefits.**

- (a) Metered Amounts. Seller shall dedicate and convey the *entire* Metered Amounts throughout the Delivery Term to SCE. Seller shall convey title to and risk of loss of all Metered Amounts to SCE at the Delivery Point.
- (b) Green Attributes. Seller hereby provides and conveys all Green Attributes associated with all electricity generation from the Project to SCE as part of the Product being delivered. Seller represents and warrants that Seller holds the rights to all Green Attributes from the Project, and Seller agrees to convey and hereby conveys all such Green Attributes to SCE as included in the delivery of the Product from the Project.
- (c) Capacity Attributes and Resource Adequacy Benefits. Subject to Section 1.08, Seller shall dedicate and convey any and all Capacity Attributes and Resource Adequacy Benefits generated by, associated with or attributable to the Generating Facility throughout the Delivery Term to SCE and SCE shall be given sole title to all such Capacity Attributes and Resource Adequacy Benefits in order for SCE to meet its resource adequacy obligations under any Resource Adequacy Rulings.

Seller represents, warrants and covenants to SCE that:

- (i) As of the Effective Date, Seller has not used, granted, pledged, assigned or otherwise committed any portion of the generating capacity of the Generating Facility to meet the Resource Adequacy Requirements of, or to confer Resource Adequacy Benefits on, any entity other than SCE during the Delivery Term; and
- (ii) Throughout the Delivery Term, Seller will not use, grant, pledge, assign or otherwise commit any portion of the generating capacity of the Generating Facility to meet the Resource Adequacy Requirements of, or to confer Resource Adequacy Benefits on, any entity other than SCE.
- (d) Further Action by Seller. Subject to Section 1.08, commencing at least six (6) months before the Commercial Operation Date and throughout the Delivery Term, Seller shall, at its own cost, take all actions and execute all documents or instruments necessary to effectuate the use of the Green Attributes, Capacity Attributes and Resource Adequacy Benefits for SCE's sole benefit throughout the Delivery Term, which actions include:
  - (i) Cooperating with and encouraging the regional entity responsible for resource adequacy administration to certify or qualify the Contract Capacity for resource adequacy purposes;
  - (ii) Testing the Generating Facility in order to certify the Generating Facility for resource adequacy purposes;

*The contents of this document are subject to restrictions on disclosure as set forth herein.*



- (iii) Complying with all current and future CAISO Tariff provisions that address resource adequacy and are applicable to the Generating Facility, including provisions regarding performance obligations and penalties, if applicable;
- (iv) Complying with Applicable Laws regarding the certification and transfer of Renewable Energy Credits, including participation in the Western Renewable Energy Generation Information System (“WREGIS”) or other process recognized under Applicable Laws for the registration, transfer or ownership of Green Attributes associated with the Generating Facility. With respect to WREGIS, Seller shall cause and allow SCE to be the “Qualified Reporting Entity” and “Account Holder” (as these two terms are defined by WREGIS) for the Generating Facility.

If Seller has sold Product (or product that would be considered “Product” under this Agreement if it were attributable to the Delivery Term) to any party other than SCE with respect to a period that is prior to the Commercial Operation Date, Seller shall, or shall cause such party to: (i) take all actions necessary for SCE to be the Account Holder as of the Commercial Operation Date, and (ii) take all actions necessary for SCE to be the Qualified Reporting Entity prior to the generation of any WREGIS Certificates associated with deliveries of Product on and after the Commercial Operation Date. SCE agrees to transfer all WREGIS Certificates associated with generation from the Generating Facility prior to the Commercial Operation Date to Seller or Seller’s designee. Seller agrees to indemnify, defend and hold harmless SCE from and against any and all loss, liability, damage, claim, cost or expense of any kind or nature (including any direct, damage, claim, cost, charge, demand, or expense, and attorneys’ fee (including the cost of in-house counsel)) and other costs of litigation, arbitration and mediation, arising out of or in connection with SCE’s transfer to Seller or Seller’s designee of WREGIS Certificates associated with renewable power generated by the Generating Facility prior to the Commercial Operation Date;

- (v) Committing to SCE the entire Metered Amounts of the Generating Facility; and
- (vi) Pursuing and obtaining any and all Capacity Attributes and Resource Adequacy Benefits to the extent that Applicable Laws, including as may be changed after the Effective Date, allow for any Capacity Attributes or Resource Adequacy Benefits to be obtained other than by the completion of Delivery Network Upgrades.

### 3.02 Resource Adequacy Performance Obligation.

Commencing on the the Commercial Operation Date, and throughout the Term, in each month, Seller shall pay to SCE an amount (the “RA Deficit Payments”) equal to the

*The contents of this document are subject to restrictions on disclosure as set forth herein.*

product of (a) the difference, expressed in kW, of (i) the Qualifying Capacity of the Generating Facility for the applicable month, minus (ii) the Net Qualifying Capacity of the Generating Facility for the applicable month, multiplied by (b) the then-current CPM Capacity price as listed in Section 43.7.1 of the CAISO Tariff or its equivalent successor (the “Multiplier”), expressed in \$/kW-month. Should the CPM Capacity price cease to be published by the CAISO and no equivalent successor is published, the Multiplier shall be equal to the last CPM Capacity price listed in the CAISO Tariff and escalated by two percent (2%) every twelve (12) months thereafter. In any event, the Multiplier may not exceed \$120/kW-year.

3.03 Other Sales of Product.

Throughout the Delivery Term, Seller shall not sell the Product (or any portion thereof) to any entity other than SCE.

3.04 Allocation of Availability Incentive Payments and Non-Availability Charges.

If the Generating Facility is subject to the terms of the Availability Standards, Non-Availability Charges, and Availability Incentive Payments as contemplated under Section 40.9 of the CAISO Tariff, any Availability Incentive Payments will be for the benefit of Seller and for Seller’s account and any Non-Availability Charges will be the responsibility of Seller and for Seller’s account.

3.05 Permits, Interconnection and Transmission Service Agreements, and CAISO Tariff Compliance.

- (a) Seller shall obtain and maintain throughout the Delivery Term any and all interconnection and transmission service rights and Permits required to effect delivery of the electric energy from the Generating Facility to the Delivery Point.
- (b) Seller shall be responsible for all costs and charges directly caused by, associated with, or allocated to the interconnection of the Generating Facility to the Transmission Provider’s electric system and transmission of electric energy from the Generating Facility to the Transmission Provider’s electric system.
- (c) Seller shall comply with the CAISO Tariff, including securing and maintaining in full force all required CAISO agreements, certifications and approvals.
- (d) Seller shall secure through the CAISO the CAISO Resource ID that is to be used solely for the Generating Facility.
- (e) Seller shall comply with the requirements of Appendix H to Appendix CC of the CAISO Tariff.

3.06 Development Security.

(a) Amount.

Seller shall post and thereafter maintain development security (“Development Security”) equal to Ninety dollars (\$90) for each kilowatt of Contract Capacity.

*The contents of this document are subject to restrictions on disclosure as set forth herein.*

(b) Posting Requirements.

Seller shall post the Development Security upon the Effective Date.

- (i) The Development Security shall be held by SCE as security for Seller achieving Commercial Operation on or before the Commercial Operation Deadline and demonstrating the Contract Capacity in accordance with the terms of this Agreement.
- (ii) The Development Security must be in the form of either a cash deposit or a Letter of Credit;
- (iii) If Seller posts any Development Security in cash, Seller will receive Simple Interest Payments in accordance with the procedure specified in Section 4.06 of this Agreement; and
- (iv) If Seller provides the Development Security by means of a Letter of Credit, such Letter of Credit must be provided substantially in the form of Exhibit L.

(c) Daily Delay Liquidated Damages to Extend Commercial Operation Deadline.

Seller may extend the Commercial Operation Deadline by paying to SCE damages in an amount equal to one percent (1%) of the Development Security per day for each day (or portion thereof) from and including the Commercial Operation Deadline to and excluding the Commercial Operation Date (“Daily Delay Liquidated Damages”).

To extend the Commercial Operation Deadline, Seller must, at the earliest possible time, but no later than 6 a.m. on the first day of the proposed Commercial Operation Deadline extension, provide SCE with Notice of its election to extend the Commercial Operation Deadline along with Seller’s estimate of the duration of the extension and its payment of Daily Delay Liquidated Damages for the full estimated Commercial Operation Deadline extension period.

Seller may further extend the Commercial Operation Deadline beyond the original Commercial Operation Deadline extension period subject to the same terms applicable to the original Commercial Operation Deadline extension.

The Daily Delay Liquidated Damages payments applicable to days included in any Commercial Operation Deadline extension are nonrefundable and are in addition to, and not a part of, the Development Security.

Seller will be entitled to a refund (without interest) of any estimated Daily Delay Liquidated Damages payments paid by Seller which exceed the amount required to cover the number of days by which the Commercial Operation Deadline was actually extended.

In no event may Seller extend the Commercial Operation Deadline for more than a total of one hundred eighty (180) days by the payment of Daily Delay Liquidated Damages.

(d) Failure to Meet the Commercial Operation Deadline.

Subject to Seller's right to extend the Commercial Operation Deadline as provided in Section 1.03, Section 3.06(c), and Section 5.03 (for Force Majeure where Seller is the Claiming Party), in the event that (i) Seller and SCE mutually agree that Commercial Operation will not occur on or before the Commercial Operation Deadline; (ii) the Commercial Operation Date will not occur due to any termination of this Agreement as a result of an Event of Default by Seller occurring on or before the Commercial Operation Deadline; (iii) the procurement of N/A for the Generating Facility does not occur within ninety (90) days after the applicable date set forth in the Milestone Schedule; or (iv) Seller abandons the Generating Facility prior to the Commercial Operation Date occurring, SCE shall be entitled to:

- (A) The entire Development Security, including the right to draw on and retain for its sole benefit any Letter of Credit and the proceeds thereof, as well as any cash, posted as Development Security; and
- (B) Terminate this Agreement;

*provided*, SCE shall give Notice to Seller of any determination under Sections 3.06(d)(iii) through (iv) that the Commercial Operation Date is unlikely to occur on or before the Commercial Operation Deadline, and if within thirty (30) days from the date of such Notice Seller can establish to SCE's reasonable satisfaction that the Commercial Operation Date is likely to occur on or before the Commercial Operation Deadline, SCE may not terminate the Agreement prior to the Commercial Operation Deadline or retain the Development Security at that time, but shall retain all other rights under this Agreement, including the right to terminate the Agreement and retain the entire Development Security if the Commercial Operation Date does not occur on or before the Commercial Operation Deadline in accordance with clause (ii) of the first paragraph of this Section 3.06(d).

If SCE terminates this Agreement pursuant to this Section 3.06(d), any amount of Development Security that Seller has not yet posted with SCE will be immediately due and payable by Seller to SCE.

In addition, subject to Section 2.04(b), if SCE terminates this Agreement pursuant to this Section 3.06(d), neither Party shall have liability for damages for failure to deliver or purchase Product after the effective date of such termination, and the Forward Settlement Amount will be Zero dollars (\$0).

(e) Full Return of Development Security.

*The contents of this document are subject to restrictions on disclosure as set forth herein.*

The Development Security will be returned to Seller in accordance with the procedure set forth in Exhibit J in each of the following circumstances:

- (i) Subject to the Commercial Operation Date occurring on or before the Commercial Operation Deadline or any extended Commercial Operation Deadline as provided in this Agreement, if Seller demonstrates the full Contract Capacity specified in Section 1.01(h) in accordance with the procedure set forth in Exhibit J; or
  - (ii) If this Agreement is terminated in accordance with Section 2.03(a)(ii) or 5.04; *provided*, a termination under Section 5.04 only entitles Seller to a return of the Development Security if the termination is based on a Force Majeure that prevents the Commercial Operation Date from occurring on or before the Commercial Operation Deadline or prevents Seller from demonstrating full Contract Capacity in accordance with Exhibit J.
- (f) Partial Return of the Development Security.
- (i) If Commercial Operation occurs on or before the Commercial Operation Deadline, but the Demonstrated Contract Capacity is less than the Contract Capacity set forth in Section 1.01(h), then Seller will be entitled to a return of only a portion of the Development Security equal to the product of Ninety dollars (\$90) per kilowatt times the kilowatts of Demonstrated Contract Capacity.
- (g) Modification of Special Conditions.
- (i) If the Contract Capacity set forth in Section 1.01(h) is greater than the Demonstrated Contract Capacity,
    - (1) The Contract Capacity will be reduced to an amount equal to the Demonstrated Contract Capacity;
    - (2) The Expected Annual Net Energy Production will be recalculated using such adjusted Contract Capacity; and
    - (3) The Performance Assurance Amount for the Performance Assurance required to be posted and maintained pursuant to Section 8.02 will be recalculated using such adjusted Contract Capacity, and any amount of Performance Assurance in excess of that required for the adjusted Contract Capacity will be returned to Seller.
  - (ii) Neither Party will have any liability for failure to purchase or deliver Product associated with or attributable to capacity in excess of the Demonstrated Contract Capacity (“Unincluded Capacity”), subject to Section 3.06(h).
- (h) Restrictions on Sales Related to Unincluded Capacity.

*The contents of this document are subject to restrictions on disclosure as set forth herein.*

- (i) Neither Seller nor Seller's Affiliates may sell, or enter into an agreement to sell, electric energy, Green Attributes, Capacity Attributes or Resource Adequacy Benefits associated with or attributable to Unincluded Capacity from any generating facility installed at the Site to a party other than SCE for a period of two (2) years following SCE's Notice to Seller of Seller's partial forfeiture of the Development Security pursuant to Exhibit J.
- (ii) With respect to Seller's Affiliates, the prohibition on contracting and sale as set forth in Section 3.06(h)(i) will not apply if, before entering into the contract or making a sale to a party other than SCE, any Seller's Affiliate wishing to enter into a contract or sale provides SCE with a written offer to sell the electric energy, Green Attributes, Capacity Attributes and Resource Adequacy Benefits related to Unincluded Capacity to SCE on terms and conditions materially similar to or no less favorable to SCE than the terms and conditions contained in this Agreement and SCE fails to accept such offer within forty-five (45) days after SCE's receipt thereof; *provided*, any Seller's Affiliate wishing to enter into a contract or sale must:
  - (1) Build a new generating facility separate from the Generating Facility to produce such additional electric energy and associated attributes;
  - (2) Establish an entity other than Seller to act as the seller for such additional electric energy and associated attributes;
  - (3) Meter such additional generating capacity separately from the Generating Facility, to SCE's reasonable satisfaction; and
  - (4) Separately interconnect such additional generating capacity to the Transmission Provider's system, to SCE's reasonable satisfaction.

If the preceding conditions are met, Seller's Affiliates (but not Seller) will be free to sell such additional electric energy and associated attributes to third parties.

### 3.07 Seller's Energy Delivery Obligation.

On the commencement of the first Term Year and for every Term Year thereafter, Seller is subject to the electric energy delivery requirements and damages for failure to perform as set forth in this Section 3.07.

#### (a) Performance Requirements.

##### (i) Seller's Energy Delivery Obligation.

"Seller's Energy Delivery Obligation" for the twelve (12) month period immediately preceding the end of each Term Year commencing at the end of the first Term Year ("Calculation Period") is ninety percent (90%) of the Expected Annual Net Energy Production.

*The contents of this document are subject to restrictions on disclosure as set forth herein.*

(ii) **Event of Deficient Energy Deliveries.**

At the end of each Term Year if the sum of the Qualified Amounts plus any Lost Output (calculated in accordance with Exhibit K) during the Term Year does not equal or exceed Seller's Energy Delivery Obligation, then an Event of Deficient Energy Deliveries will be deemed to have occurred.

(b) **Product Replacement Damage Amount.**

If an Event of Deficient Energy Deliveries occurs, as determined in accordance with Section 3.07(a)(ii) above, the Parties acknowledge that the damages sustained by SCE associated with an Event of Deficient Energy Deliveries would be difficult or impossible to determine, or that obtaining an adequate remedy would be unreasonably time consuming or expensive, and therefore agree that Seller shall pay SCE as liquidated damages an amount which is intended to compensate SCE for Seller's failure to perform, irrespective of whether SCE actually purchased replacement Product by reason of Seller's failure to perform (the "Product Replacement Damage Amount").

- (i) Within ninety (90) days after the end of the applicable Term Year, SCE shall calculate any Product Replacement Damage Amount as set forth in Exhibit F, and shall provide Notice to Seller of any Product Replacement Damage Amount owing, including a detailed explanation of, and rationale for, its calculation methodology, annotated work papers and source data.
- (ii) Seller shall have thirty (30) days after receipt of SCE's Notice to review SCE's calculation and either pay the entire Product Replacement Damage Amount claimed by SCE or pay any undisputed portion and provide Notice to SCE of the portion Seller disputes along with a detailed explanation of, and rationale for, Seller's calculation methodology, annotated work papers and source data.
- (iii) The Parties shall negotiate in good faith to resolve any disputed portion of the Product Replacement Damage Amount and shall, as part of such good faith negotiations, promptly provide information or data relevant to the dispute as each Party may possess which is requested by the other Party.
- (iv) If the Parties are unable to resolve a dispute regarding any Product Replacement Damage Amount within thirty (30) days after the sending of a Notice of dispute by Seller, either Party may submit the dispute to mediation and arbitration as provided in Article Twelve.

(c) **Continuing Obligations of Seller.**

Notwithstanding any payment of a Product Replacement Damage Amount, all of Seller's obligations under Sections 3.01 and 3.02 continue to apply.

3.08 **Metering, Communications, Telemetry and Meteorological Station(s).**

*The contents of this document are subject to restrictions on disclosure as set forth herein.*

(a) CAISO Approved Meter.

Seller shall, at its own cost, install, maintain and test all CAISO Approved Meters pursuant to the CAISO Tariff.

(b) Check Meter.

Seller will permit SCE to furnish and install one Check Meter on the high voltage side of the step-up transformer, substation, or any other location at SCE's sole discretion, associated with the Generating Facility in compliance with the applicable utility electric service requirements. Each Check Meter must be interconnected with SCE's communication network to permit:

- (i) Periodic, remote collection of revenue quality meter data; and
- (ii) Back-up real time transmission of operating-quality meter data.

(b) SCE's Access to Meters.

- (i) Subject to Section 3.18, Seller hereby grants SCE reasonable access to all CAISO Approved Meters and Check Meters for meter readings and any purpose necessary to effectuate this Agreement.
- (ii) Seller shall promptly provide SCE access to all meter data and data acquisition services both in real-time, and at later times, as SCE may reasonably request.
- (iii) Prior to the Commercial Operation Date, Seller shall provide instructions to the CAISO granting authorizations or other documentation sufficient to provide SCE with access to the CAISO Approved Meter(s) and to Seller's settlement data on OMAR.

(c) CAISO Approved Meter Maintenance.

- (i) Seller shall test and calibrate the CAISO Approved Meter(s), as necessary, but in no event will the period between testing and calibration dates be greater than twelve (12) months.
- (ii) Seller shall bear its own costs for any meter check or recertification of the CAISO Approved Meter(s).
- (iii) Seller shall replace each CAISO Approved Meter battery at least once every thirty-six (36) months or such shorter period as may be recommended by the CAISO Approved Meter manufacturer.

Notwithstanding the foregoing, if a CAISO Approved Meter battery fails, Seller shall replace such battery within one (1) day after becoming aware of its failure.

- (iv) Seller shall use certified test and calibration technicians to perform any work associated with the CAISO Approved Meter(s).



- (v) Seller shall inform SCE of test and calibration dates, provide SCE with access to observe and witness such testing and calibration, and provide SCE certified results of tests and calibrations within thirty (30) days after completion.
- (d) SCADA and Telemetry System.
- All communication, metering, telemetry, and associated generation operation equipment will be centralized into the Generating Facility's SCADA. Seller shall configure the SCADA so that SCE may access it via the GMS from the GOC. Seller shall link the systems via an approved SCE communication network, utilizing existing industry standard network protocol, as approved by SCE. The connection will be bidirectional in nature and used by the Parties to exchange all data points to and from the GOC. Seller shall be responsible for the costs of installing, configuring, maintaining and operating the SCADA and internal site links for the Generating Facility.
- Seller shall be responsible for designing, furnishing, installing, operating, maintaining and testing a real time Telemetry System capable of interconnecting to the GMS, the CAISO Approved Meter(s) and the Generating Facility's control system with the CAISO's Energy Communication Network.
- The Telemetry System shall be designed in accordance with the CAISO monitoring and communication requirements and must be capable of:
- (i) Reporting data from each CAISO Approved Meter;
  - (ii) Providing the status of key control points from the Generating Facility's control system;
  - (iii) Routing generating unit set points to the Generating Facility's control system; and
  - (iv) Communicating availability of the Generating Facility pursuant to Section 3.08(g).
- The Telemetry System must include a data processing gateway, internet connection, interconnecting cabling and all service agreements required for accessing the CAISO's Energy Communications Network.
- The above mentioned connections and data transfer must be included in the systems engineering tasks as a part of the construction of the Generating Facility, and must be fully functional before Commercial Operation.
- (e) [Intentionally Deleted.]
- (f) Real-Time Communication of Availability.
- (i) Prior to the Commercial Operation Date, Seller shall install a telecommunication system and demonstrate to SCE's reasonable

*The contents of this document are subject to restrictions on disclosure as set forth herein.*

satisfaction that the system interfaces with the Web Client and the GMS to provide SCE with Seller's Real-Time Availability.

- (ii) Seller shall maintain the telecommunications path, the hardware, and software to provide quality data to SCE throughout the Delivery Term.
- (iii) Upon Notice from SCE, Seller shall repair or have corrected as soon as possible, but no later than five (5) days after receipt of such Notice any:
  - (1) Inoperable telecommunications path;
  - (2) Inoperable software; or
  - (3) Faulty instrumentation.
- (iv) Seller shall submit an Actual Availability Report pursuant to Section 3.22 for any month in which Seller's telecommunications system was not available or did not provide quality data for longer than twenty-four (24) continuous hours.

### 3.09 Site Location and Control.

- (a) This Agreement is Site specific as set forth in Section 1.01(b). Seller may change the location of the Site only upon SCE's prior written consent, which consent is in SCE's sole discretion.
- (b) Seller shall have Site Control from the Effective Date and continuing throughout the Term.
- (c) Seller shall provide SCE with prompt Notice of any change in the status of Seller's Site Control.

### 3.10 Change in Structure, Ownership or Financing.

Seller shall provide Notice to SCE within five (5) Business Days after a change in the status of any of the following:

- (a) Seller's exact and complete name, form of organization, direct or indirect ownership and state of incorporation or organization, or address of Seller's principal place of business; and
- (b) Seller's construction-period financing and Operating-period financing, including the sources of equity investments and debt financings.

No Notice provided pursuant to this Section 3.10 constitutes or substitutes for any consent required pursuant to Sections 10.04 or 10.05.

### 3.11 Design.

At no cost to SCE, Seller shall be responsible for:

- (a) Designing and constructing the Generating Facility;
- (b) Using commercially reasonable efforts to acquire all Permits;

*The contents of this document are subject to restrictions on disclosure as set forth herein.*

- (c) Providing to SCE, at least thirty (30) days before the anticipated Commercial Operation Date, the following Generating Facility information:
  - (i) Site plan drawings for the Generating Facility;
  - (ii) Electrical one-line diagrams;
  - (iii) Control and data-acquisition details and configuration documents;
  - (iv) Major electrical equipment specifications;
  - (v) General arrangement drawings;
  - (vi) Longitude and latitude of each generator;
  - (vii) Artist renderings of the Site, if any;
  - (viii) Aerial photographs of the Site, if any;
  - (ix) Process flow diagrams;
  - (x) Piping and instrumentation diagrams;
  - (xi) Non-condensable gas composition;
  - (xii) Map showing the location of the Meteorological Equipment, including specifying the longitude and latitude of such.
  - (xiii) Copies of all Shared Facilities Agreements.
  
- (d) Providing SCE advance Notice at the earliest practicable time of any proposed material changes in the Generating Facility, but in no event less than thirty (30) days before the changes are to be made, which Notice must include the information set forth in Section 3.11(c), along with all specifications and drawings pertaining to any such changes and any changes to Exhibit B. SCE shall retain the right to review such proposed changes and accept or reject such changes in its sole discretion.
  
- (e) Providing to SCE, prior to commencement of any construction activities on the Site, a report from an independent engineer (acceptable to both SCE and Seller) certifying that Seller has a written plan for the safe construction and Operation of the Generating Facility in accordance with Prudent Electrical Practices.

### 3.12 Operation and Record Keeping.

- (a) Seller shall Operate the Generating Facility in accordance with Prudent Electrical Practices.
- (b) Seller shall comply with Operating orders in compliance with the CAISO Tariff.
- (c) On or prior to the Commercial Operation Date:
  - (i) SCE shall have obtained or waived CPUC Approval;

- (ii) Seller shall obtain CEC Pre-Certification;
  - (iii) Seller shall take all steps necessary to ensure that SCE becomes authorized by the CAISO to Schedule the electric energy produced by the Generating Facility with the CAISO;
  - (iv) SCE shall have been authorized by the CAISO to Schedule the electric energy produced by the Generating Facility with the CAISO;
  - (v) Seller shall demonstrate to SCE's reasonable satisfaction that Seller has executed all necessary Transmission Provider and CAISO agreements;
  - (vi) Seller shall provide to SCE the DLF used by the Transmission Provider in the administration of the transmission service agreement for the Generating Facility;
  - (vii) Seller shall be Forecasting to SCE in accordance with Exhibit D;
  - (viii) Seller shall commence delivering electric energy to SCE at the Delivery Point and the Generating Facility is operating in parallel with Seller's Transmission Provider;
  - (ix) [Intentionally Deleted.]
  - (x) Seller shall have registered with the NERC as the Generating Facility's Generator Owner and Generator Operator if Seller is required to be a registered entity pursuant to the NERC Reliability Standards; and
  - (xi) Seller shall have furnished to SCE all insurance documents required under Section 10.11.
- (d) Seller shall keep a daily operations log for the Generating Facility that shall include the following information:
- (i) Availability of the Generating Facility;
  - (ii) Circuit breaker trip operations;
  - (iii) Any significant events related to the Operation of the Generating Facility;
  - (iv) Real and reactive power and energy production;
  - (v) Changes in Operating status;
  - (vi) Protective apparatus operations;
  - (vii) Any unusual conditions found during inspections;
  - (viii) Electric energy production, fuel consumption and efficiency (if applicable); and
  - (ix) Status and settings of generator controls including automatic voltage regulator and power system stabilizer.

- (e) Seller shall log changes in the generator output setting if it is “block-loaded” to a specific kW capacity. Seller shall maintain complete records of the Generating Facility’s fuel consumption if a biomass or landfill generating facility, or geothermal fluid consumption if a geothermal generating facility.
- (f) Seller shall keep a maintenance log for the Generating Facility that shall include information on maintenance (both breakdown and preventative) performed, outages, inspections, manufacturer recommended services and replacement, electrical characteristics of the generators, control settings or adjustments of equipment and protective devices.

Seller shall maintain documentation of all procedures applicable to the testing and maintenance of the Generating Facility protective devices as necessary to comply with NERC Reliability Standards applicable to protection systems for large electric generators, if Seller is required to be a registered entity pursuant to the NERC Reliability Standards.

Such information in Sections 3.12(d), 3.12(e) and 3.12(f) above shall be provided or made available to SCE within twenty (20) days after any Notice.

- (g) Seller shall promptly curtail the production of the Generating Facility:
  - (i) Upon Notice from SCE that Seller has been instructed by the CAISO or Transmission Provider to curtail energy deliveries; *provided*, solely the action of the CAISO issuing a Schedule shall not by itself constitute an instruction by the CAISO to curtail energy deliveries pursuant to this Section 3.12(g)(i);
  - (ii) Upon Notice that Seller has been given a curtailment order or similar instruction in order to respond to an Emergency; or
  - (iii) If SCE issues a Curtailment Order.
- (h) Information maintained pursuant to this Section 3.12 shall be kept by Seller throughout the Delivery Term and shall be provided or made available to SCE within twenty (20) days after any Notice.
- (i) Seller must be interfaced with SCE’s Generation Management System and be responsive to 5-minute Dispatch Instruction and other applicable CAISO Tariff rules.

### 3.13 Obtaining Scheduling Coordinator Services.

Seller shall comply with all applicable CAISO Tariff procedures, protocol, rules and testing as necessary for SCE to submit Bids for the electric energy produced by the Generating Facility.

- (a) Designating SCE as Scheduling Coordinator.
  - (i) At least thirty (30) days before the Commercial Operation Date, Seller shall take all actions and execute and deliver to SCE all documents

*The contents of this document are subject to restrictions on disclosure as set forth herein.*

necessary to authorize or designate SCE as the Scheduling Coordinator throughout the Delivery Term.

- (ii) Throughout the Delivery Term, Seller shall not authorize or designate any other party to act as Scheduling Coordinator, nor shall Seller perform, for its own benefit, the duties of Scheduling Coordinator.
- (iii) Seller is responsible for and shall pay SCE an amount equal to the costs (including the costs of SCE employees or agents) SCE incurs, as determined in SCE's sole discretion, as a result of SCE being designated as the Generating Facility's Scheduling Coordinator including the costs associated with the registration of the Generating Facility with the CAISO, and the installation, configuration, and testing of all equipment and software necessary for SCE to act as Scheduling Coordinator or to Schedule the Generating Facility ("SC Set-Up Fee"); *provided*, the SC Set-up Fee shall not exceed \$20,000.

(b) Replacement of SCE as Scheduling Coordinator.

At least forty-five (45) days before the end of the Term, or as soon as practicable before the date of any termination of this Agreement before the end of the Term, Seller shall take all actions necessary to terminate the designation of SCE as Seller's Scheduling Coordinator as of hour ending 24:00 on the last day of the Term. These actions include the following:

- (i) Seller shall submit to the CAISO a designation of a new Scheduling Coordinator for Seller to replace SCE;
- (ii) Seller shall cause the newly designated Scheduling Coordinator to submit a letter to the CAISO accepting the designation; and
- (iii) Seller shall inform SCE of the last date on which SCE will be Seller's Scheduling Coordinator. SCE must consent to any date other than the last day of the Term, such consent not to be unreasonably withheld.

3.14 Forecasting.

Seller shall Forecast in accordance with the provisions of Exhibit D.

Seller shall use commercially reasonable efforts to Operate the Generating Facility so that the available capacity or electric energy from the Generating Facility conforms with Forecasts provided in accordance with Exhibit D.

3.15 Scheduled Outages.

- (a) Commencing at least sixty (60) days before the Commercial Operation Date and throughout the Delivery Term, Seller shall, no later than January 1, April 1, July 1 and October 1 of each year, submit to SCE, using the Web Client, Seller's schedule of proposed planned outages ("Outage Schedule") for the subsequent twenty-four month period.

*The contents of this document are subject to restrictions on disclosure as set forth herein.*

- (b) Seller shall provide the following information for each proposed planned outage:
  - (i) Start date and time;
  - (ii) End date and time; and
  - (iii) Capacity online, in MW, during the planned outage.
- (c) Within thirty (30) days after SCE's receipt of an Outage Schedule, SCE shall notify Seller in writing of any reasonable request for changes to the Outage Schedule, and Seller shall, consistent with Prudent Electrical Practices, accommodate SCE's requests regarding the timing of any planned outage.
- (d) Seller shall cooperate with SCE to arrange and coordinate all Outage Schedules with the CAISO.
- (e) If a condition occurs at the Generating Facility which causes Seller to revise its planned outages, Seller shall promptly provide Notice to SCE, using the Web Client, of such change (including an estimate of the length of such planned outage) as required in the CAISO Tariff after the condition causing the change becomes known to Seller.
- (f) Seller shall promptly prepare and provide to SCE upon request, using the Web Client, all reports of actual or forecasted outages that SCE may reasonably require for the purpose of enabling SCE to comply with Section 761.3 of the California Public Utilities Code or any Applicable Law mandating the reporting by investor owned utilities of expected or experienced outages by electric energy generating facilities under contract to supply electric energy.

3.16 Progress Reporting Toward Meeting Milestone Schedule.

Seller shall use commercially reasonable efforts to meet the Milestone Schedule and avoid or minimize any delays in meeting this schedule. Seller shall provide a monthly written report of its progress toward meeting the Milestone Schedule using the procedures set forth in Exhibit H.

Seller shall include in such report a list of all letters, notices, applications, approvals, authorizations, filings, permits and licenses relating to any Transmission Provider, Governmental Authority or the CAISO and shall provide any such documents as may be reasonably requested on Notice from SCE.

In addition, Seller shall advise SCE as soon as reasonably practicable of any problems or issues of which Seller is aware which may materially impact Seller's ability to meet the Milestone Schedule.

A report delivered pursuant to this Section 3.16 shall not constitute Notice for any purpose under this Agreement, including with respect to any fact, circumstance, request, issue, dispute or matter included in such report.

3.17 [Intentionally Deleted.]

3.18 Provision of Information.

*The contents of this document are subject to restrictions on disclosure as set forth herein.*

Seller shall promptly provide to SCE copies of:

- (a) Within ten (10) Business Days of receipt thereof, copies of any Interconnection Study or the interconnection agreement tendered to Seller by the Transmission Provider and, concurrently with the provision of the first Interconnection Study or interconnection agreement tendered to Seller by the Transmission Provider that may give rise to a termination right of SCE under Section 2.03(b), Seller shall also provide SCE a Notice of Seller's irrevocable election to exercise or not exercise its right to assume financial responsibility for any Excess Network Upgrade Costs pursuant to Section 2.03(b), with a failure to provide such an election deemed to be an election not to exercise such rights;
- (b) All applications and approvals or disapprovals relating to CEC Pre-Certification, CEC Certification, CEC Verification, any Permit and PIRP/EIRP (in the event SCE requests Seller to apply to be in PIRP/EIRP);
- (c) All final and revised copies of material reports, studies and analyses furnished by the CAISO or any Transmission Provider, and any correspondence related thereto, concerning the interconnection of the Generating Facility to the Transmission Provider's electric system or the transmission of electric energy on the Transmission Provider's electric system;
- (d) All notifications of adjustments in the DLF used by the Transmission Provider in the administration of the transmission service agreement for the Generating Facility within thirty (30) days of receiving such notification from the Transmission Provider;
- (e) [Intentionally Deleted.]
- (f) Any reports, studies, or assessments of the Generating Facility prepared for Seller by an independent engineer; and
- (g) All Generating Facility and metering information as may be requested by SCE, including the following, at least thirty (30) days before the Commercial Operation Date:

For each CAISO Approved Meter:

- (i) Generating Station/Unit ID;
- (ii) CAISO Resource ID;
- (iii) CAISO Approved Meter Device ID;
- (iv) Password;
- (v) Data path (network (ECN) or modem);
- (vi) If modem, phone number;
- (vii) Copy of meter certification;

*The contents of this document are subject to restrictions on disclosure as set forth herein.*



- (viii) List of any CAISO metering exemptions (if any); and
- (ix) Description of any compensation calculations such as transformer losses and line losses.

For the Generating Facility:

- (1) Utility transmission/distribution one line diagram;
  - (2) Physical location, address or descriptive identification;
  - (3) Latitude and longitude of each generator of the Generating Facility;
  - (4) Telephone number on site;
  - (5) Telephone number of control room;
  - (6) Telephone number for operational issues; and
  - (7) Telephone number for administrative issues.
- (h) No later than twenty (20) days after each semi-annual period ending on June 30<sup>th</sup> or December 31<sup>st</sup>, a report listing all Diverse Business Enterprises that supplied goods or services to Seller during such period, including any certifications or other documentation of such Diverse Business Enterprises status as such and the aggregate amount paid to Diverse Business Enterprises during such period.
- (i) SCE has the right to disclose to the CPUC all such information provided by Seller pursuant to this Section 3.17(i).
  - (ii) Seller shall make reasonable efforts to accommodate requests by the CPUC (or by SCE in response to a request by the CPUC) to audit Seller in order to verify data provided by Seller pursuant to this Section 3.17(i).
- (i) Internal Revenue Service tax Form W-9 and California tax Form 590 (or their equivalent), completed with Seller's information, and any other documentation necessary for SCE to comply with its tax reporting or withholding obligations with respect to Seller, within ten (10) Business Days of Seller's receipt of Notice from SCE requesting the same.

### 3.19 SCE's Access Rights.

Seller hereby grants SCE the right of ingress and egress to examine the Site and Generating Facility for any purpose reasonably connected with this Agreement or the exercise of any and all rights of SCE under Applicable Law or SCE's tariff schedules and rules on file with the CPUC. When at the Site, SCE, its authorized agents, employees and inspectors shall adhere to safety and security procedures as may reasonably be required by Seller, provided Seller has provided such procedures to SCE in writing in advance.

### 3.20 Obtaining and Maintaining CEC Certification, and CEC Verification.

*The contents of this document are subject to restrictions on disclosure as set forth herein.*

- (a) Within thirty (30) days after the Commercial Operation Date, Seller shall file an application or other appropriate request with the CEC for CEC Certification for the Generating Facility.
- (b) Subject to Section 1.08, Seller shall take all necessary steps, including making or supporting timely filings with the CEC, to obtain and maintain CEC Certification and CEC Verification throughout the Delivery Term.
- (c) Upon request by SCE, Seller shall provide copies of all correspondence and documentation exchanged between the CEC and Seller.

### 3.21 Notice of Cessation or Termination of Service Agreements.

Seller shall provide Notice to SCE within one (1) Business Day after termination of, or cessation of service under, any agreement necessary to deliver Product to SCE at the Delivery Point or to meter the Metered Amounts.

### 3.22 Lost Output Report.

#### (a) Monthly Report; SCE Review.

Commencing on the Commercial Operation Date and continuing throughout the Term, Seller shall calculate Lost Output and prepare and provide to SCE a Lost Output Report by the tenth (10th) Business Day of each month in accordance with Exhibit K.

SCE will have thirty (30) days after receipt of Seller's monthly Lost Output Report or Supplemental Lost Output Report to review such report.

Upon SCE's request, Seller shall promptly provide to SCE any additional data and supporting documentation necessary for SCE to audit and verify any matters in the Lost Output Report.

#### (b) Disputes of Lost Output.

If SCE disputes Seller's Lost Output calculation, SCE shall provide Notice to Seller within thirty (30) days after receipt of Seller's Lost Output Report and include SCE's calculations and other data supporting its position.

The Parties shall negotiate in good faith to resolve any dispute.

If the Parties are unable to resolve a dispute within thirty (30) days after SCE's giving the dispute Notice, either Party may submit the dispute to mediation and arbitration as provided in Article Twelve.

Seller will have no right to claim any Lost Output for any month that was not identified in the original Lost Output Report for that month; *provided*, Seller may supplement the amount of Lost Output claimed ("Supplemental Lost Output") for the month with a supplemental Lost Output Report ("Supplemental Lost Output Report") if Seller can demonstrate that Seller neither knew nor could have known through the exercise of reasonable diligence about the Supplemental Lost Output within the foregoing thirty (30) day period and Seller provides the Supplemental

*The contents of this document are subject to restrictions on disclosure as set forth herein.*

Lost Output Report within ten (10) Business Days after learning the facts which provide the basis for the Supplemental Lost Output claim; *provided further*, in no event will SCE be obligated to accept a Supplemental Lost Output Report after thirty (30) days following the end of the applicable Term Year.

(c) Product Replacement Damage Amount Calculation.

The Lost Output amount that will be used by SCE in the Product Replacement Damage Amount calculation, set forth in Exhibit F, will be the amount calculated pursuant to Exhibit K or otherwise resolved pursuant to Section 3.21(b).

3.23 Actual Availability Report.

- (a) Throughout the Delivery Term, Seller shall prepare and provide to SCE a report with the Actual Available Capacity of the Generating Facility (an “Actual Availability Report”) for each month.

This report must be in the form set forth in Exhibit N and must be delivered to SCE no later than the seventh (7th) Business Day following the end of the month which is the subject of the Actual Availability Report.

- (b) Upon SCE’s request, Seller shall promptly provide to SCE any additional data and supporting documentation necessary for SCE to audit and verify any matters set forth in the Actual Availability Report.

3.24 [Intentionally Deleted.]

3.25 [Intentionally Deleted.]

3.26 [Intentionally Deleted.]

3.27 NERC Reliability Standards.

Throughout the Delivery Term, Seller shall be:

- (a) Responsible for complying with any NERC Reliability Standards applicable to the Generating Facility, including registration with NERC as the Generator Operator for the Generating Facility or other applicable category under the NERC Reliability Standards and implementation of all applicable processes and procedures required by NERC, WECC or CAISO for compliance with the NERC Reliability Standards; and
- (b) Liable for all penalties assessed by NERC (through WECC, the CAISO or otherwise) for violations of the NERC Reliability Standards by the Generating Facility or Seller, as Generator Operator or other applicable category.

However, if Seller learns that NERC (through WECC or otherwise) is considering or intends to assess Seller with a penalty that Seller believes is attributable to SCE’s actions or inactions as SC as described in the document entitled “NERC Reliability Standards - Responsibilities of the Generator Operator, Scheduling Coordinator, CAISO, and Reliability Coordinator” or other successor description or document on the CAISO website at the time of the potential assessment, Seller shall provide SCE with sufficient

*The contents of this document are subject to restrictions on disclosure as set forth herein.*

notice to allow SCE to take part in administrative processes, discussions or settlement negotiations with NERC, WECC or other entity arising from or related to the alleged violation or possible penalty. If the penalty is nonetheless assessed in spite of SCE's participation in the processes, discussions or settlement negotiations, or SCE waives its right to take part in the processes, discussion or settlement negotiations, SCE shall reimburse Seller for the penalty to the extent that:

- (c) It was solely caused by SCE's actions or inactions as SC as described in the document entitled "NERC Reliability Standards - Responsibilities of the Generator Operator, Scheduling Coordinator, CAISO, and Reliability Coordinator" or other successor description or document on the CAISO website at the time of the violation; and
- (d) Seller can establish to SCE's reasonable satisfaction that the penalty was actually assessed against Seller by NERC and paid by Seller to NERC.

### 3.28 Application of Prevailing Wage.

To the extent applicable, Seller shall comply with the prevailing wage requirements of Public Utilities Code Section 399.14, subdivision (h).

---

\*\*\* End of ARTICLE THREE \*\*

**ARTICLE FOUR. SCE'S OBLIGATIONS**4.01 Obligation to Pay and Invoice.

- (a) SCE shall provide information to Seller regarding CAISO Revenues, CAISO Costs, CAISO Sanctions, and SCE Penalties and shall pay Seller, all in accordance with Exhibit E.
- (b) Throughout the Delivery Term, SCE shall purchase Product generated by the Generating Facility and delivered at the Delivery Point in accordance with this Agreement, CAISO Tariff and Applicable Law, provided, subject to Section 4.01(c), SCE has no obligation to purchase from Seller any Product that is not or cannot be delivered to the Delivery Point as a result of any circumstance, including:
  - (i) An outage of the Generating Facility;
  - (ii) A Force Majeure under Article Five; or
  - (iii) A reduction or curtailment of deliveries in accordance with Section 3.12(g), except as set forth in Section 4.01(c).
- (c) Subject to Section 4.01(e), SCE will be obligated to pay Seller for any CP in each Term Year, in accordance with Exhibit E.
- (d) SCE will not be obligated to pay Seller for any Product that Seller delivers in violation of Section 3.12(g), and Seller shall pay all CAISO Sanctions and CAISO Costs, and SCE shall retain all CAISO Revenues resulting from such violation of Section 3.12(g).

4.02 SCE's Check Meter.(a) Providing Access to Seller.

Before Commercial Operation, SCE shall provide to Seller remote access to the Check Meter through a website as specified by SCE. SCE may change the website and protocols from time to time.

(b) Testing of Check Meter.

SCE may test and recalibrate the Check Meter(s) at least once every Term Year. The Check Meter(s) will be locked or sealed, and the lock or seal will be broken, only by a SCE representative. Seller has the right to be present whenever such lock or seal is broken. SCE shall replace the battery of the Check Meter(s) at least once every 36 months; *provided*, if a Check Meter battery fails, SCE shall promptly replace such battery.

(c) Use of Check Meter for Back-Up Purposes.

- (i) SCE shall routinely compare the Check Meter data to the CAISO Approved Meter data after adjusting the Check Meter for any compensation introduced by the CAISO into the CAISO Approved Meter.

*The contents of this document are subject to restrictions on disclosure as set forth herein.*

- (ii) If the deviation between the CAISO Approved Meter data and the Check Meter data for any comparison is greater than 0.3%, SCE shall provide Notice to Seller of such deviation and the Parties will mutually arrange for a meter check or recertification of the Check Meter or CAISO Approved Meter, as applicable.
- (iii) SCE will bear its own costs for any meter check or recertification of the Check Meter.
- (d) Testing procedures and standards for the Check Meter(s) will be the same as for a comparable SCE-owned revenue-grade meter. Seller has the right to have representatives present during all such tests.

#### 4.03 Scheduling Coordinator.

Commencing on the Commercial Operation Date, SCE shall act as Seller's Scheduling Coordinator and carry out all duties as Scheduling Coordinator in accordance with CAISO Tariff protocols.

#### 4.04 Termination of Scheduling Coordinator.

SCE shall submit a letter to the CAISO identifying the date on which SCE resigns as Seller's Scheduling Coordinator on the first to occur of the following:

- (a) Thirty (30) days before the end of the Term;
- (b) The date of any Notice from Seller of suspension of its performance pursuant to Section 6.02; or
- (c) The date of any early termination of this Agreement.

#### 4.05 Exclusive Rights to Product and Cost Responsibility.

- (a) SCE has the exclusive right, at any time or from time to time, to sell, assign, convey, transfer, allocate, designate, award, report or otherwise provide any and all such Green Attributes, Capacity Attributes or Resource Adequacy Benefits conveyed by Seller to SCE during the Delivery Term to third parties; *provided*, no such action constitutes a transfer of, or a release of SCE of, its obligations under this Agreement.
- (b) Subject to Seller's obligations under this Agreement, including, without limitation, Sections 3.01, 3.02, 3.08, 3.12, 3.19, and 10.03(b), SCE shall be responsible for any costs arising from or directly related to SCE's accounting for or otherwise claiming Green Attributes, Capacity Attributes and Resource Adequacy Benefits.

#### 4.06 Interest Payments on Cash Deposits.

- (a) SCE shall make monthly Simple Interest Payments, calculated using the Federal Funds Effective Rate, to Seller on cash amounts posted for the:
  - (i) Development Security; and

*The contents of this document are subject to restrictions on disclosure as set forth herein.*

- (ii) Performance Assurance.
- (b) Upon receipt of a monthly invoice (provided by Seller to SCE's Manager of Credit and Collateral as set forth in Exhibit C) that sets forth the calculation of the Simple Interest Payment amount due, SCE shall make payment thereof by the third (3rd) Business Day of the first month after the last month to which the invoice relates so long as such date is after the day on which such invoice is received; *provided*,
  - (i) No Event of Default has occurred and is continuing with respect to Seller; and
  - (ii) No Early Termination Date for which any unsatisfied payment obligation of Seller exists, has occurred or has been designated as the result of an Event of Default by Seller.
- (c) On or after the occurrence of an Event of Default by Seller or an Early Termination Date as a result of an Event of Default by Seller, SCE will retain any such Simple Interest Payment amount as an additional Development Security amount or a Performance Assurance amount hereunder until:
  - (i) In the case of an Early Termination Date, the obligations of Seller under this Agreement have been satisfied; or
  - (ii) In the case of an Event of Default, for so long as such Event of Default is continuing.

---

\*\*\* End of ARTICLE FOUR \*\*\*

## ARTICLE FIVE. FORCE MAJEURE

### 5.01 No Default for Force Majeure.

Neither Party will be considered to be in default in the performance of any of its obligations set forth in this Agreement (except for obligations to pay money) when and to the extent failure of performance is caused by Force Majeure.

### 5.02 Requirements Applicable to the Claiming Party.

If a Party, because of Force Majeure, is rendered wholly or partly unable to perform its obligations when due under this Agreement, that Party (the “Claiming Party”), will be excused from whatever performance is affected by the Force Majeure to the extent so affected, *provided*, the Claiming Party must have complied with (a) and (b) directly below.

In order to be excused from its performance obligations hereunder by reason of Force Majeure:

- (a) The Claiming Party, within fourteen (14) days after the initial occurrence of the claimed Force Majeure, must give the other Party Notice describing the particulars of the occurrence; and
- (b) The Claiming Party must provide timely evidence reasonably sufficient to establish that the occurrence constitutes Force Majeure as defined in this Agreement.

The suspension of the Claiming Party’s performance due to Force Majeure will be of no greater scope and of no longer duration than is required by the Force Majeure.

In addition, the Claiming Party shall use commercially reasonable and diligent efforts to remedy its inability to perform.

This Section 5.02 does not require the settlement of any strike, walkout, lockout or other labor dispute on terms which, in the sole judgment of the Claiming Party, are contrary to its interest.

It is understood and agreed that the settlement of strikes, walkouts, lockouts or other labor disputes will be at the sole discretion of the Claiming Party.

When the Claiming Party is able to resume performance of its obligations under this Agreement, the Claiming Party shall give the other Party prompt Notice to that effect.

### 5.03 Commercial Operation Deadline Extension.

If the Commercial Operation Date does not occur on or before the Commercial Operation Deadline as the result of a Force Majeure occurring before the Commercial Operation Deadline, then the Commercial Operation Deadline will, subject to Sections 1.03 and 5.04 and Seller’s compliance with its obligations as the Claiming Party under Section 5.02, be extended on a day-for-day basis for the duration of the Force Majeure.



## 5.04 Termination.

Either Party may terminate this Agreement on Notice, which will be effective five (5) Business Days after such Notice is provided, if (a) an event of Force Majeure extends for more than three hundred sixty-five (365) consecutive days and materially and adversely affects the operations of the Claiming Party, or (b) the Generating Facility is destroyed or rendered inoperable by a Force Majeure, and an independent, third-party engineer determines in writing that the Generating Facility cannot be repaired or replaced within twenty-four (24) months after the first day of such Force Majeure.

---

\*\*\* End of ARTICLE FIVE \*\*\*

**ARTICLE SIX. EVENTS OF DEFAULT; REMEDIES**6.01 Events of Default.

An “Event of Default” means, with respect to a Party (a “Defaulting Party”), the occurrence of any of the following:

- (a) With respect to either Party:
  - (i) Any representation or warranty made by such Party herein is false or misleading in any material respect when made or when deemed made or repeated if the representation or warranty is continuing in nature, *provided*, if:
    - (1) The misrepresentation or breach of warranty is capable of a cure, an Event of Default will be deemed to occur if the misrepresentation or breach of warranty is not remedied within five (5) Business Days after Notice from the non-breaching Party; or
    - (2) The misrepresentation or breach of warranty is not capable of a cure, but the non-breaching Party’s damages resulting from the inaccuracy can reasonably be ascertained, an Event of Default will be deemed to occur if the payment of such damages is not made within ten (10) Business Days after a Notice of these damages is provided from the non-breaching Party;
  - (ii) Except for an obligation to make payment when due, the failure to perform any material covenant or obligation set forth in this Agreement (except to the extent constituting a separate Event of Default specified below or to the extent excused by a Force Majeure) if this failure is not remedied within thirty (30) days after Notice of the failure, which Notice sets forth in reasonable detail the nature of the failure; *provided*, if the failure is not reasonably capable of being cured within the thirty (30) day cure period specified above, the Party will have such additional time (not exceeding an additional one hundred twenty (120) days) as is reasonably necessary to cure the failure, so long as the Party promptly commences and diligently pursues the cure;
  - (iii) A Party fails to make when due any payment required under this Agreement and this failure is not cured within five (5) Business Days after Notice of the failure;
  - (iv) A Party becomes Bankrupt; or
  - (v) A Party consolidates or amalgamates with, or merges with or into, or transfers all or substantially all of its assets to, another entity and, at the time of such consolidation, amalgamation, merger or transfer, the resulting, surviving or transferee entity fails to assume all the obligations

*The contents of this document are subject to restrictions on disclosure as set forth herein.*

of that Party under this Agreement either by operation of law or pursuant to an agreement reasonably satisfactory to the other Party.

- (b) With respect to Seller:
- (i) Seller fails to post and maintain the Development Security pursuant to Section 3.06(a), and such failure is not cured within three (3) Business Days after Notice from SCE;
  - (ii) Seller fails to post and maintain the Performance Assurance pursuant to Section 8.02, and such failure is not cured within three (3) Business Days after Notice from SCE;
  - (iii) Commercial Operation does not occur on or before the Commercial Operation Deadline;
  - (iv) Except as permitted in Sections 10.04 and 10.05, Seller does not own or otherwise have control of the Generating Facility;
  - (v) Seller does not have Site Control in accordance with Section 3.09 and Seller has not cured such failure within sixty (60) days after the occurrence of the event which results in the failure.
  - (vi) The sum of Qualified Amounts plus Lost Output in any consecutive six (6) month period is not at least ten percent (10%) of the Expected Annual Net Energy Production, and Seller fails to demonstrate to SCE's reasonable satisfaction, within ten (10) Business Days after Notice from SCE, a legitimate reason for the failure to meet the ten percent (10%) minimum;
  - (vii) The Metered Amounts in any one hour interval, in kWh, exceed one hundred fifteen percent (115%) of the Contract Capacity, in kW, to this Agreement, (an "Event of Excess Deliveries"), without the prior written consent of SCE, and within ten (10) Business Days after Notice from SCE, Seller fails to demonstrate to SCE's satisfaction that Seller has identified the reason that the Event of Excess Deliveries occurred and that Seller has employed or is employing best efforts to ensure that no additional Events of Excess Deliveries will occur throughout the Delivery Term;
  - (viii) Seller intentionally or knowingly Forecasts or delivers, or attempts to Forecast or deliver, at the Delivery Point for sale under this Agreement electric energy that was not in fact generated by the Generating Facility;
  - (ix) [Intentionally Deleted];
  - (x) [Intentionally Deleted];
  - (xi) Seller removes from the Site equipment upon which the Contract Capacity has been based, except for the purposes of replacement, refurbishment, repair or maintenance, and the equipment is not returned within five (5) Business Days after Notice from SCE;

---

*The contents of this document are subject to restrictions on disclosure as set forth herein.*

- (xii) The Generating Facility consists of an ERR type(s) different than that specified in Section 1.01(g);
- (xiii) Except where there has been a change in Applicable Laws that would affect Seller's status as an ERR, and Seller has made commercially reasonable efforts in accordance with Section 10.02(b) to comply with the change in law, the Generating Facility fails to qualify as an ERR;
- (xiv) Except where there has been a change in Applicable Law that would affect the eligibility of electric energy to qualify as renewable energy for the purposes of the RPS Legislation and Seller has made commercially reasonable efforts in accordance with Section 10.02(c) to comply with the change in law, any electric energy from the Generating Facility and sold or to be sold to SCE hereunder fails to qualify as eligible renewable energy for purposes of the RPS Legislation;
- (xv) A termination of, or cessation of service under, any agreement necessary for Seller:
  - (1) To interconnect the Generating Facility to the Transmission Provider's electric system;
  - (2) To transmit the electric energy on the Transmission Provider's electric system; or
  - (3) To comply with the CAISO Tariff;

*provided*, if SCE and Seller mutually agree that a termination of, or cessation of service under, any such agreement is not due to the fault of Seller, Seller shall have thirty (30) days from such termination or cessation to cure such default;
- (xvi) Subject to Section 1.08, Seller fails to take any actions necessary to dedicate, convey or effectuate the use of any and all Green Attributes, Capacity Attributes and Resource Adequacy Benefits for SCE's sole benefit as specified in Section 3.01;
- (xvii) Except for Credit and Collateral Requirements in Article Eight for which there is a separate Event of Default specified in this Section 6.01, Seller fails to satisfy the Credit and Collateral Requirements in Article Eight and the failure is not cured within three (3) Business Days after Notice from SCE;
- (xviii) Subject to the terms of a Collateral Assignment Agreement, the occurrence and continuation of a default, event of default or other similar condition or event under one or more agreements or instruments relating to indebtedness for borrowed money, which results in the indebtedness becoming, or becoming capable at such time of being declared, immediately due and payable;

*The contents of this document are subject to restrictions on disclosure as set forth herein.*

- (xix) The stock, equity ownership interest in Seller or assets of Seller has been pledged or assigned as collateral or otherwise to any party other than Lender;
- (xx) Seller transfers or assigns the Interconnection Queue Position or the interconnection agreement without the written consent of SCE;
- (xxi) [Intentionally Deleted];
- (xxii) Seller fails to take all commercially reasonable actions, including any actions required in Seller's interconnection agreement, to expeditiously obtain Full Capacity Deliverability Status.

## 6.02 Early Termination.

If an Event of Default shall have occurred, the Party taking the default (the "Non-Defaulting Party") has the right:

- (a) To designate by Notice, which will be effective five (5) Business Days after the Notice is given, a day, no later than twenty (20) calendar days after the Notice is effective, for the early termination of this Agreement (an "Early Termination Date"); *provided*, a Non-Defaulting Party's right to terminate this Agreement pursuant to this Section 6.02(a) may only be exercised within one hundred and eighty (180) days from the date that the default giving rise to the applicable Event of Default is no longer continuing, or, if no cure period is provided for, from the date the Non-Defaulting Party becomes aware of the Event of Default; and
- (b) To pursue all remedies available at law or in equity against the Defaulting Party (including monetary damages), except to the extent that such remedies are limited by the terms of this Agreement.

Upon the effective designation of an Early Termination Date, the Non-Defaulting Party will have the right to immediately suspend performance under this Agreement, including performance under Section 3.03 but excluding the obligation to post and maintain Development Security and Performance Assurance in accordance with Section 3.06 or Article Eight.

## 6.03 Termination Payment.

As soon as practicable after an Early Termination Date is declared, the Non-Defaulting Party shall provide Notice to the Defaulting Party of the Termination Payment.

The Notice must include a written statement setting forth, in reasonable detail, the calculation of such Termination Payment including the Forward Settlement Amount, together with appropriate supporting documentation.

If the Termination Payment is positive, the Defaulting Party shall pay such amount to the Non-Defaulting Party within ten (10) Business Days after the Notice is provided. If the

*The contents of this document are subject to restrictions on disclosure as set forth herein.*

Termination Payment is negative (i.e., the Non-Defaulting Party owes the Defaulting Party more than the Defaulting Party owes the Non-Defaulting Party), then the Non-Defaulting Party shall pay such amount to the Defaulting Party within thirty (30) days after the Notice is provided.

The Parties shall negotiate in good faith to resolve any disputes regarding the calculation of the Termination Payment. Any Disputes which the Parties are unable to resolve through negotiation may be submitted for resolution through mediation and arbitration as provided in Article Twelve.

---

\*\*\* End of ARTICLE SIX \*\*\*

**ARTICLE SEVEN. LIMITATIONS OF LIABILITIES**

EXCEPT AS SET FORTH HEREIN, THERE ARE NO WARRANTIES BY EITHER PARTY UNDER THIS AGREEMENT, INCLUDING ANY WARRANTY OF MERCHANTABILITY OR FITNESS FOR A PARTICULAR PURPOSE, AND ANY AND ALL IMPLIED WARRANTIES ARE DISCLAIMED. THE PARTIES CONFIRM THAT THE EXPRESS REMEDIES AND MEASURES OF DAMAGES PROVIDED IN THIS AGREEMENT SATISFY THE ESSENTIAL PURPOSES HEREOF.

FOR BREACH OF ANY PROVISION FOR WHICH AN EXPRESS REMEDY OR MEASURE OF DAMAGES IS PROVIDED, SUCH EXPRESS REMEDY OR MEASURE OF DAMAGES WILL BE THE SOLE AND EXCLUSIVE REMEDY, THE OBLIGOR'S LIABILITY WILL BE LIMITED AS SET FORTH IN SUCH PROVISION AND ALL OTHER REMEDIES OR DAMAGES AT LAW OR IN EQUITY ARE WAIVED, UNLESS THE PROVISION IN QUESTION PROVIDES THAT THE EXPRESS REMEDIES ARE IN ADDITION TO OTHER REMEDIES THAT MAY BE AVAILABLE.

SUBJECT TO SECTION 12.04, IF NO REMEDY OR MEASURE OF DAMAGES IS EXPRESSLY PROVIDED HEREIN, THE OBLIGOR'S LIABILITY WILL BE LIMITED TO DIRECT ACTUAL DAMAGES ONLY, SUCH DIRECT ACTUAL DAMAGES WILL BE THE SOLE AND EXCLUSIVE REMEDY AND ALL OTHER REMEDIES OR DAMAGES AT LAW OR IN EQUITY ARE WAIVED.

UNLESS EXPRESSLY PROVIDED IN THIS AGREEMENT, INCLUDING WITHOUT LIMITATION THE PROVISIONS OF SECTION 10.03 (INDEMNITY), NEITHER PARTY WILL BE LIABLE FOR CONSEQUENTIAL, INCIDENTAL, PUNITIVE, EXEMPLARY OR INDIRECT DAMAGES, LOST PROFITS OR OTHER BUSINESS INTERRUPTION DAMAGES, BY STATUTE, IN TORT OR CONTRACT, UNDER ANY INDEMNITY PROVISION OR OTHERWISE.

IT IS THE INTENT OF THE PARTIES THAT THE LIMITATIONS HEREIN IMPOSED ON REMEDIES AND THE MEASURE OF DAMAGES BE WITHOUT REGARD TO THE CAUSE OR CAUSES RELATED THERETO, INCLUDING THE NEGLIGENCE OF ANY PARTY, WHETHER SUCH NEGLIGENCE BE SOLE, JOINT OR CONCURRENT, OR ACTIVE OR PASSIVE.

TO THE EXTENT ANY DAMAGES REQUIRED TO BE PAID HEREUNDER ARE LIQUIDATED, THE PARTIES ACKNOWLEDGE THAT THE DAMAGES ARE DIFFICULT OR IMPOSSIBLE TO DETERMINE, OR OTHERWISE OBTAINING AN ADEQUATE REMEDY IS INCONVENIENT AND THE DAMAGES CALCULATED HEREUNDER CONSTITUTE A REASONABLE APPROXIMATION OF THE HARM OR LOSS.

NOTHING IN THIS ARTICLE PREVENTS, OR IS INTENDED TO PREVENT SCE FROM PROCEEDING AGAINST OR EXERCISING ITS RIGHTS WITH RESPECT TO ANY DEVELOPMENT SECURITY, OR PERFORMANCE ASSURANCE.

---

*\*\*\* End of ARTICLE SEVEN \*\*\**

*The contents of this document are subject to restrictions on disclosure as set forth herein.*

**ARTICLE EIGHT. CREDIT AND COLLATERAL REQUIREMENTS****8.01 Financial Information.**

- (a) If requested by one Party, the other Party shall deliver the following financial statements, which in all cases must be for the most recent accounting period and prepared in accordance with GAAP:
  - (i) Within one hundred twenty (120) days following the end of each fiscal year, a copy of its annual report containing audited consolidated financial statements (income statement, balance sheet, statement of cash flows and statement of retained earnings and all accompanying notes) for such fiscal year, setting forth in each case in comparative form the figures for the previous year; and
  - (ii) Within sixty (60) days after the end of each of its first three fiscal quarters of each fiscal year, a copy of its quarterly report containing consolidated financial statements (income statement, balance sheet, statement of cash flows and statement of retained earnings and all accompanying notes) for such fiscal quarter and the portion of the fiscal year through the end of such quarter, setting forth in each case in comparative form the figures for the previous year.
- (b) In each case, the financial statements specified in Sections 8.01(a)(i) and 8.01(a)(ii) above must be:
  - (i) Certified in accordance with all applicable laws and regulations, including all applicable SEC rules and regulations, if such Party is an SEC reporting company; or
  - (ii) Certified by a Responsible Officer as being fairly stated in all material respects (subject to normal year end audit adjustments) if such Party is not an SEC reporting company;
- (c) For purposes of the requirement set forth in Section 8.01(a)
  - (i) If a Party's financial statements are publicly available electronically on the website of that Party or the SEC, then the Party shall be deemed to have met the requirements of Section 8.01(a); and
  - (ii) Should any such financial statements not be available on a timely basis due to a delay in preparation or certification, that delay will not be an Event of Default so long as the producing party diligently pursues the preparation, certification and delivery of the statements.

**8.02 Development Security and Performance Assurance.****(a) Posting Performance Assurance.**

On or before the Commercial Operation Date, Seller shall post Performance Assurance with SCE.

*The contents of this document are subject to restrictions on disclosure as set forth herein.*



The Performance Assurance Amount due to SCE by Seller will be as set forth in Section 1.06.

The Performance Assurance Amount shall be posted to SCE and maintained at all times during the Term and thereafter until such time as Seller has satisfied all monetary obligations which survive any termination of this Agreement, not to exceed one year following the end of the Term.

The Performance Assurance Amount must be either in the form of cash or Letter of Credit acceptable to SCE, *provided*, on the commencement of the Term, if Seller has posted the Development Security in the form of cash or a Letter of Credit and SCE has not either returned the Development Security to Seller or given Seller Notice, pursuant to Exhibit J, of its determination regarding the disposition of the Development Security by such date, then Seller may withhold the portion of the Performance Assurance Amount equal to the Development Security or any portion thereof held by SCE at that time until three (3) Business Days following the later of Seller's receipt or forfeiture of the Development Security or any portion thereof pursuant to Section 3.06 and Exhibit J, after which Seller shall be obligated to post the full Performance Assurance Amount.

(b) Letters of Credit.

Development Security and Performance Assurance provided in the form of a Letter of Credit must be subject to the following provisions:

- (i) Each Letter of Credit must be maintained for the benefit of SCE;
- (ii) Seller shall:
  - (1) Renew or cause the renewal of each outstanding Letter of Credit on a timely basis as provided in the relevant Letter of Credit;
  - (2) If the bank that issued an outstanding Letter of Credit has indicated its intent not to renew such Letter of Credit, provide alternative Development Security or Performance Assurance acceptable to SCE at least twenty (20) Business Days before the expiration of the outstanding Letter of Credit; and
  - (3) If the bank issuing a Letter of Credit fails to honor SCE's properly documented request to draw on an outstanding Letter of Credit, provide alternative Development Security or Performance Assurance acceptable to SCE within three (3) Business Days after such refusal;
- (iii) Upon the occurrence of a Letter of Credit Default, Seller shall provide to SCE either a substitute Letter of Credit or alternative Development Security or Performance Assurance acceptable to SCE, in each case on or before the third (3rd) Business Day after the occurrence thereof;

*The contents of this document are subject to restrictions on disclosure as set forth herein.*

- (iv) Upon, or at any time after, the occurrence and continuation of an Event of Default by Seller, or if an Early Termination Date has occurred or been designated as a result of an Event of Default by Seller for which there exist any unsatisfied payment obligations, then SCE may draw on any undrawn portion of any outstanding Letter of Credit upon submission to the bank issuing such Letter of Credit of one or more certificates specifying that such Event of Default or Early Termination Date has occurred and is continuing.

In addition, SCE will have the right to draw on the Letter of Credit for any of the following reasons:

- (1) The Letter of Credit will expire in fewer than twenty (20) Business Days and Seller has not provided SCE alternative Development Security or Performance Assurance acceptable to SCE.
- (2) The Seller or the issuer of the Letter of Credit has provided written notice to SCE of either Seller's or the issuer's intent not to renew the Letter of Credit following the present expiration date thereof ("Notice of Non-Renewal"), and Seller has failed to provide SCE with a replacement Letter of Credit satisfactory to SCE in its sole discretion within thirty (30) days following the date of the Notice of Non-Renewal.
- (3) SCE has not been paid any or all of Seller's payment obligations due and payable under the Agreement.

Cash proceeds received by SCE from drawing upon the Letter of Credit pursuant to this Section 8.02(b)(iv) (except item (3) above for payment obligations due and payable) will be deemed Development Security or Performance Assurance (as applicable) as security for Seller's obligations to SCE and SCE will have the rights and remedies set forth in Section 8.03 with respect to such cash proceeds.

Notwithstanding SCE's receipt of cash proceeds of a drawing under the Letter of Credit, Seller shall remain liable for any:

- (4) Failure to provide or maintain the required Development Security or Performance Assurance (including failure to replenish a Letter of Credit to the full Development Security or Performance Assurance Amount in the event that SCE draws against the Letter of Credit for any reason other than to satisfy a Termination Payment); or
- (5) Any amounts owing to SCE and remaining unpaid after the application of the amounts so drawn by SCE; and

- (v) In all cases, the costs and expenses of establishing, renewing, replenishing, substituting, canceling, and increasing the amount of any and all Letters of Credit will be borne by Seller.

#### 8.03 First Priority Security Interest in Cash or Cash Equivalent Collateral.

To secure its obligations under this Agreement, and until released as provided herein, Seller hereby grants to SCE a present and continuing first-priority security interest (“Security Interest”) in, and lien on (and right to net against), and assignment of the Development Security, Performance Assurance, any other cash collateral and cash equivalent collateral posted pursuant to Sections 3.06 and 8.02 and any and all interest thereon or proceeds resulting therefrom or from the liquidation thereof, whether now or hereafter held by, on behalf of, or for the benefit of SCE, and Seller agrees to take all action as SCE reasonably requires in order to perfect SCE’s Security Interest in, and lien on (and right to net against), such collateral and any and all proceeds resulting therefrom or from the liquidation thereof.

Upon or any time after the occurrence of an Event of Default caused by Seller, an Early Termination Date resulting from an Event of Default caused by Seller, or an occasion provided for in this Agreement where SCE is authorized to retain all or a portion of the Development Security or Performance Assurance, SCE may do any one or more of the following:

- (a) Exercise any of its rights and remedies with respect to the Development Security and Performance Assurance, including any such rights and remedies under law then in effect;
- (b) Draw on any outstanding Letter of Credit issued for its benefit and retain any cash held by SCE as Development Security or Performance Assurance; and
- (c) Liquidate all Development Security or Performance Assurance (as applicable) then held by or for the benefit of SCE free from any claim or right of any nature whatsoever of Seller, including any equity or right of purchase or redemption by Seller.

SCE shall apply the proceeds of the collateral realized upon the exercise of any such rights or remedies to reduce Seller’s obligations under this Agreement (Seller remains liable for any amounts owing to SCE after such application), subject to SCE’s obligation to return any surplus proceeds remaining after these obligations are satisfied in full.

#### 8.04 Credit and Collateral Covenants.

- (a) Seller shall, from time to time as requested by SCE, execute, acknowledge, record, register, deliver and file all such notices, statements, instruments and other documents as may be necessary or advisable to render fully valid and enforceable under all applicable laws the rights, liens and priorities of SCE with respect to the Security Interest provided for herein and therein.

- (b) Seller may not cause or permit the stock, equity ownership interest in Seller or assets of Seller to be pledged or assigned as collateral or otherwise to any party other than Lender.
- (c) Seller may not create, incur, issue, assume, guarantee or otherwise become directly or indirectly liable for, contingently or otherwise, any Seller's Debt, or issue any Disqualified Stock, in each case, other than Seller's Debt incurred, issued, assumed or guaranteed, or Disqualified Stock issued, in connection with the funding of the development, construction or Operation of the Generating Facility.
- (d) Except for liens for the benefit of Lender, Seller may not create, incur, assume or suffer to be created by it or any subcontractor, employee, laborer, materialman, other supplier of goods or services or any other person, any lien on Seller's interest (or any part thereof) in this Agreement, the Site or the Generating Facility.
- (e) Seller promptly shall pay or discharge, or shall cause its contractors to promptly pay and discharge, and discharge of record, any such lien for labor, materials, supplies or other obligations upon Seller's interest in the Site, the Generating Facility, or any part thereof or interest therein, unless Seller is disputing any such lien in good faith and only for so long as it does not create an imminent risk of a sale or transfer of the Generating Facility or a material part thereof.
- (f) Seller shall promptly notify SCE of any attachment or imposition of any lien against Seller's interest (or any part thereof) in the Site, the Generating Facility, or any part thereof or interest therein.
- (g) Seller may not hold any material assets, become liable for any material obligations or engage in any material business activities other than the development, construction and Operation of the Generating Facility.
- (h) Seller may not own, form or acquire, or otherwise conduct any of its activities through, any direct or indirect subsidiary.
- (i) During any period during which Seller is a Defaulting Party, Seller may not:
  - (i) Declare or pay any dividend, or make any other distribution or payment, on account of any equity interest in Seller; or
  - (ii) Otherwise make any distribution or payment to any Affiliate of Seller.

#### 8.05 Commercial Code Waiver.

This Agreement sets forth the entirety of the agreement of the Parties regarding credit, collateral and adequate assurances. Except as expressly set forth in Article Eight of this Agreement, neither Party:

- (a) Has or will have any obligation to post margin, provide letters of credit, pay deposits, make any other prepayments or provide any other financial assurances, in any form whatsoever; or
- (b) Will have reasonable grounds for insecurity with respect to the creditworthiness of a Party that is complying with the relevant provisions of Article Eight of this Agreement;

and all implied rights relating to financial assurances arising from Section 2609 of the California Commercial Code or case law applying similar doctrines, are hereby waived.

#### 8.06 Consolidation of Seller's Financial Statements.

- (a) Buyer shall determine, through consultation with its internal accountants and review with their independent registered public accounting firm, whether Buyer is required to consolidate Seller's financial statements with Buyer's financial statements for financial accounting purposes under Accounting Standards Codification (ASC) 810/Accounting Standards Update 2009-17, "Consolidation of Variable Interest Entities" (ASC 810), or future guidance issued by accounting profession governance bodies or the SEC that affects Buyer accounting treatment for this Agreement (the "Financial Consolidation Requirement").
- (b) If the Financial Consolidation Requirement is applicable, then:
  - (i) Within 20 days following the end of each calendar year (for each year that such treatment is required), Seller shall deliver to Buyer unaudited financial statements and related footnotes, if applicable, of Seller as of the end of the year. The annual financial statements should include quarter-to-date and yearly information. Buyer shall provide to Seller a checklist before the end of each year listing the items which Buyer believes are material to Buyer and required for this purpose, and Seller shall provide the information on the checklist, subject to the availability of data from Seller's records. It is permissible for Seller to use accruals and prior months' estimates with true-up to actual activity, in subsequent periods, when preparing unaudited financial statements and the information on the checklist. If audited financial statements are prepared for Seller for the year, Seller shall provide such statements to Buyer within five Business Days after those statements are issued.
  - (ii) Within 15 days following the end of each fiscal quarter (for each quarter that such treatment is required), Seller shall deliver to Buyer unaudited financial statements and related footnotes, if applicable, of Seller as of the end of the quarterly period. The financial statements should include quarter-to-date and year-to-date information. Buyer shall provide to Seller a checklist before the end of each quarter listing items which Buyer believes are material to Buyer and required for this purpose, and Seller shall provide the information on the checklist, subject to the availability of

*The contents of this document are subject to restrictions on disclosure as set forth herein.*

- data from Seller's records. It is permissible for Seller to use accruals and prior months' estimates with true-up to actual activity, in subsequent periods, when preparing the unaudited financial statements and the information on the checklist.
- (iii) If Seller regularly prepares its financial data in accordance with GAAP, IFRS, or any successor to either of the foregoing ("Successor"), the financial information provided to Buyer shall be prepared in accordance with such principles. If Seller is not a SEC registrant and does not regularly prepare its financial data in accordance with GAAP, IFRS or Successor, the information provided to Buyer shall be prepared in a format consistent with Seller's regularly applied accounting principles, e.g., the format that Seller uses to provide financial data to its auditor.
- (c) If the Financial Consolidation Requirement is applicable, then promptly upon Notice from Buyer, Seller shall allow Buyer's independent registered public accounting firm such access to Seller's records and personnel, as reasonably required so that Buyer's independent registered public accounting firm can conduct financial statement audits in accordance with the standards of the Public Company Accounting Oversight Board (United States), as well as internal control audits in accordance with Section 404 of the Sarbanes-Oxley Act of 2002, as applicable. All expenses for the foregoing work of SCE's independent registered public accounting firm shall be borne by Buyer. If Buyer's independent registered public accounting firm during or as a result of the audits permitted in this Section 8.06(c) determines a material weakness or significant deficiency, as defined by GAAP, IFRS or Successor, as applicable, exists in Seller's internal controls over financial reporting, then within 90 days of Seller's receipt of Notice from Buyer, Seller shall remediate any such material weakness or significant deficiency; *provided, however*, that Seller has the right to challenge the appropriateness of any determination of material weakness or significant deficiency. Seller's true up to actual activity for yearly or quarterly information as provided herein shall not be evidence of material weakness or significant deficiency.
- (d) Buyer shall treat Seller's financial statements and other financial information provided under the terms of this Section 8.06 in strict confidence and, accordingly:
- (i) Shall utilize such Seller financial information *only* for purposes of preparing, reviewing or certifying Buyer's or any Buyer parent company financial statements, for making regulatory, tax or other filings required by law in which Buyer is required to demonstrate or certify its or any parent company's financial condition or to obtain credit ratings;
  - (ii) Shall make such Seller financial information available only to its officers, directors, employees or auditors who are responsible for preparing,

*The contents of this document are subject to restrictions on disclosure as set forth herein.*

reviewing or certifying Buyer's or any Buyer parent company financial statements, to the SEC and the Public Company Accounting Oversight Board (United States) in connection with any oversight of Buyer's or any Buyer parent company financial statement and to those Persons who are entitled to receive confidential information as identified in Section 10.10; and

- (iii) Buyer shall ensure that its internal auditors and independent registered public accounting firm (1) treat as confidential any information disclosed to them by Buyer pursuant to this Section 8.06, (2) use such information solely for purposes of conducting the audits described in this Section 8.06, and (3) disclose any information received only to personnel responsible for conducting the audits.
- (e) If the Financial Consolidation Requirement is applicable, then, within two Business Days following the occurrence of any event from the Effective Date through the last day of the Term affecting Seller which Seller would be required to disclose in a Form 8-K filing with the SEC if Seller was subject to the form 8-K filing requirements, Seller shall provide to Buyer a Notice describing such event in sufficient detail to permit Buyer to make a Form 8-K filing.
- (f) If, after consultation and review, the Parties do not agree on issues raised by Section 8.06(a), then such dispute shall be subject to review by another independent audit firm not associated with either Party's respective independent registered public accounting firm, reasonably acceptable to both Parties. This third independent audit firm will render its recommendation on whether consolidation by Buyer is required. If the independent audit firm associated with Buyer still determines, after review by the third party independent audit firm, that Buyer must consolidate, then Seller shall provide the financial information necessary to permit consolidation to Buyer; *provided, however*, that in addition to the protections in Section 8.06(d), such information shall be password protected and available only to those specific officers, directors, employees and auditors who are preparing and certifying the consolidated financial statements and not for any other purpose.

---

\*\*\* End of ARTICLE EIGHT \*\*\*

**ARTICLE NINE. GOVERNMENTAL CHARGES**9.01 Cooperation to Minimize Tax Liabilities.

Each Party shall use reasonable efforts to implement the provisions of and to administer this Agreement in accordance with the intent of the Parties to minimize all taxes, so long as neither Party is materially adversely affected by such efforts.

9.02 Governmental Charges.

Seller shall pay or cause to be paid all taxes imposed by any Governmental Authority (“Governmental Charges”) on or with respect to the Metered Amounts (and any contract associated with the Metered Amounts) arising before the Delivery Point, including ad valorem taxes and other taxes attributable to the Generating Facility, land, land rights or interests in land for the Generating Facility.

SCE shall pay or cause to be paid all Governmental Charges on or with respect to the Metered Amounts at and from the Delivery Point. If Seller is required by law or regulation to remit or pay Governmental Charges which are SCE’s responsibility hereunder, SCE shall promptly reimburse Seller for such Governmental Charges.

If SCE is required by law or regulation to remit or pay Governmental Charges which are Seller’s responsibility hereunder, SCE may deduct such amounts from monthly Product Payments to Seller made pursuant to Exhibit E.

If SCE elects not to deduct such amounts from Seller’s monthly Product Payments, Seller shall promptly reimburse SCE for such amounts upon SCE’s Payment Invoice request. Nothing shall obligate or cause a Party to pay or be liable to pay any Governmental Charges for which that Party is exempt under the law.

9.03 Providing Information to Taxing Authorities.

Seller or SCE, as necessary, shall provide information concerning the Generating Facility to any requesting taxing authority.

---

\*\*\* End of ARTICLE NINE \*\*\*



**ARTICLE TEN. MISCELLANEOUS****10.01 Representations and Warranties.**

On the Effective Date, each Party represents and warrants to the other Party that:

- (a) It is duly organized, validly existing and in good standing under the laws of the jurisdiction of its formation;
- (b) Except for CPUC Approval in the case of SCE, and all Permits in the case of Seller, it has or will timely acquire all regulatory authorizations necessary for it to legally perform its obligations under this Agreement;
- (c) The execution, delivery and performance of this Agreement are within its powers, have been duly authorized by all necessary action and do not violate any of the terms and conditions in its governing documents, any contracts to which it is a party or any law, rule, regulation, order or the like applicable to it;
- (d) This Agreement constitutes a legally valid and binding obligation enforceable against it in accordance with its terms, subject to any Equitable Defenses;
- (e) There is not pending, or to its knowledge, threatened against it or, in the case of Seller, any of its Affiliates, any legal proceedings that could materially adversely affect its ability to perform under this Agreement;
- (f) No Event of Default with respect to it has occurred and is continuing and no such event or circumstance would occur as a result of its entering into or performing its obligations under this Agreement;
- (g) It is acting for its own account and its decision to enter into this Agreement is based upon its own judgment, not in reliance upon the advice or recommendations of the other Party and it is capable of assessing the merits of and understanding, and understands and accepts the terms, conditions and risks of this Agreement; and
- (h) It has not relied upon any promises, representations, statements or information of any kind whatsoever that are not contained in this Agreement in deciding to enter into this Agreement.

**10.02 Additional Seller Representations, Warranties and Covenants.**

- (a) Seller hereby covenants to SCE that throughout the Delivery Term:
  - (i) Seller shall own and Operate the Generating Facility;
  - (ii) Seller shall deliver to SCE the Product free and clear of all liens, security interests, claims and encumbrances or any interest therein or thereto by any person;
  - (iii) Seller shall hold the rights to all Green Attributes, Capacity Attributes and Resource Adequacy Benefits, which Seller has conveyed and has committed to convey to SCE hereunder;

*The contents of this document are subject to restrictions on disclosure as set forth herein.*

- (iv) Seller shall obtain, maintain and remain in compliance with all Permits, interconnection agreements and transmission rights necessary to Operate the Generating Facility and to deliver electric energy from the Generating Facility to the Delivery Point;
  - (v) Subject to Section 1.08, Seller shall take all actions necessary for the Project to qualify and be certified by the CEC as an ERR; and
  - (vi) Subject to Section 1.08, Seller shall take all actions necessary for the Product delivered to SCE to qualify under the requirements of the California Renewables Portfolio Standard.
- (b) Seller, and, if applicable, its successors, represents and warrants that throughout the Delivery Term of this Agreement that:
- (i) The Project qualifies and is certified by the CEC as an Eligible Renewable Energy Resource (“ERR”) as such term is defined in Public Utilities Code Section 399.12 or Section 399.16; and
  - (ii) The Project’s output delivered to Buyer qualifies under the requirements of the California Renewables Portfolio Standard.

To the extent a change in law occurs after execution of this Agreement that causes this representation and warranty to be materially false or misleading, it shall not be an Event of Default if Seller has used commercially reasonable efforts to comply with such change in law.

- (c) Seller and, if applicable, its successors, represents and warrants that throughout the Delivery Term of this Agreement the Renewable Energy Credits transferred to Buyer conform to the definition and attributes required for compliance with the California Renewables Portfolio Standard, as set forth in California Public Utilities Commission Decision 08-08-028, and as may be modified by subsequent decision of the California Public Utilities Commission or by subsequent legislation. To the extent a change in law occurs after execution of this Agreement that causes this representation and warranty to be materially false or misleading, it shall not be an Event of Default if Seller has used commercially reasonable efforts to comply with such change in law.

The term “commercially reasonable efforts” as used in Section 10.02(b) and Section 10.02(c) means efforts consistent with and subject to Section 1.08.

- (d) Seller warrants that all necessary steps to allow the Renewable Energy Credits transferred to Buyer to be tracked in the Western Renewable Energy Generation Information System will be taken prior to the first delivery under the contract.
- (e) Seller hereby represents and warrants that, as of the Effective Date, it has no knowledge of any plans by SCE or another Transmission Provider to seek to construct a transmission or distribution line through or on the Site.
- (f) [Intentionally Deleted].

*The contents of this document are subject to restrictions on disclosure as set forth herein.*

**10.03 Indemnity.****(a) SCE's Indemnification Obligations.**

In addition to any other indemnification obligations SCE may have elsewhere in this Agreement, which are hereby incorporated in this Section 10.03(a), SCE releases, and shall indemnify, defend and hold harmless Seller, and Seller's directors, officers, employees, agents, assigns, and successors in interest, from and against any and all loss, liability, damage, claim, cost, charge, demand, fine, penalty or expense of any kind or nature (including any direct, damage, claim, cost, charge, demand, or expense, and attorneys' fees (including cost of in-house counsel) and other costs of litigation, arbitration and mediation, and in the case of third-party claims only, indirect and consequential loss or damage of such third-party), arising out of or in connection with:

- (i) any breach made by SCE of its representations and warranties in Sections 10.01 and 10.02; and
- (ii) so long as Seller has fully complied with the Generator Operator Obligations and Generator Owner Obligations, any NERC Standards Non-Compliance Penalties which are solely due to SCE's negligence in performing its role as Seller's Scheduling Coordinator throughout the Delivery Term.

This indemnity applies notwithstanding Seller's active or passive negligence. However, Seller will not be indemnified hereunder for its loss, liability, damage, claim, cost, charge, demand or expense to the extent caused by its gross negligence or willful misconduct.

**(b) Seller's Indemnification Obligations.**

In addition to any other indemnification obligations Seller may have elsewhere in this Agreement, which are hereby incorporated in this Section 10.03(b), Seller releases, and shall indemnify, defend and hold harmless SCE, and SCE's directors, officers, employees, agents, assigns, and successors in interest, from and against any and all loss, liability, damage, claim, cost, charge, demand, penalty, fine or expense of any kind or nature (including any direct, damage, claim, cost, charge, demand, or expense, and attorneys' fees (including cost of in-house counsel) and other costs of litigation, arbitration or mediation, and in the case of third-party claims only, including claims arising from a breach of Section 10.02(b), indirect or consequential loss or damage of such third-party), arising out of or in connection with:

- (i) any breach made by Seller of its representations and warranties in Sections 10.01 and 10.02;

- (ii) Seller's failure to fulfill its obligations regarding Resource Adequacy Benefits as set forth in Sections 3.01 and 3.02;
- (iii) NERC Standards Non-Compliance Penalties or an attempt by any Governmental Authority, person or entity to assess such NERC Standards Non-Compliance Penalties against SCE, except to the extent solely due to SCE's negligence in performing its role as Seller's Scheduling Coordinator throughout the Delivery Term;
- (iv) injury or death to persons, including SCE employees, and physical damage to property, including SCE property, where the damage arises out of, is related to, or is in connection with, Seller's construction, ownership or Operation of the Generating Facility, or obligations or performance under this Agreement;
- (v) injury or death to any person or damage to any property, including the personnel or property of SCE, to the extent that SCE would have been protected had Seller complied with all of the provisions of Section 10.11; *provided*, the inclusion of this Section 10.03(b)(v) is not intended to create any express or implied right in Seller to elect not to provide the insurance required under Section 10.11;
- (vi) any breach by Seller of the covenants set forth in Section 2.04(b);
- (vii) the disqualification by WREGIS or any Governmental Authority of any Renewable Energy Credits transferred to SCE, or the failure to transfer any Renewable Energy Credits to Buyer within four (4) months after the generation of the associated Metered Amounts.

This indemnity applies notwithstanding SCE's active or passive negligence. However, SCE will not be indemnified under Section 10.03(b)(i) through Section 10.03(b)(iv) for its loss, liability, damage, claim, cost, charge, demand or expense to the extent caused by its gross negligence or willful misconduct.

(c) Mutual Indemnification.

Each Party shall indemnify, defend and hold harmless the other Party and the other Party's directors, officers, employees, agents, assigns, and successors in interest, from and against any and all loss, liability, damage, claim, cost, charge, demand, fine, penalty or expense of any kind or nature (including direct, indirect, or consequential loss, damage, claim, cost, charge, demand, or expense, including attorneys' fees (including costs of in-house counsel) and other costs of litigation, arbitration or mediation), arising out of or in connection with a Party's failure to pay any Governmental Charges for which such Party is responsible under Article Nine.

(d) Indemnification Claims.

*The contents of this document are subject to restrictions on disclosure as set forth herein.*

All claims for indemnification by a Party entitled to be indemnified under this Agreement (an “Indemnified Party”) by the other Party (the “Indemnitor”) will be asserted and resolved as follows:

- (i) If a claim or demand for which an Indemnified Party may claim indemnity is asserted against or sought to be collected from an Indemnified Party by a third party, the Indemnified Party shall as promptly as practicable give Notice to the Indemnitor; *provided*, failure to provide this Notice will relieve Indemnitor only to the extent that the failure actually prejudices Indemnitor.
- (ii) Indemnitor will have the right to control the defense and settlement of any claims in a manner not adverse to Indemnified Party but cannot admit any liability or enter into any settlement without Indemnified Party’s approval.
- (iii) Indemnified Party may employ counsel at its own expense with respect to any claims or demands asserted or sought to be collected against it; *provided*, if counsel is employed due to a conflict of interest or because Indemnitor does not assume control of the defense, Indemnitor will bear the expense of this counsel.

(e) Survival of Indemnification Rights and Obligations.

All indemnity rights and obligations survive the termination of this Agreement for twelve (12) months.

10.04 Assignment.

- (a) Except as provided in Section 10.05, neither Party can assign this Agreement or its rights hereunder without the prior written consent of the other Party, which consent shall not be unreasonably withheld.
- (b) Any direct or indirect change of control of Seller (whether voluntary or by operation of law) will be deemed an assignment and will require the prior written consent of SCE, which consent shall not be unreasonably withheld.

10.05 Consent to Collateral Assignment.

Subject to the provisions of this Section 10.05, Seller has the right to assign this Agreement as collateral for any financing or refinancing of the Generating Facility; *provided*, Seller shall be responsible for SCE’s reasonable costs associated with the preparation, review, execution and delivery of documents in connection with any such assignment, including without limitation attorneys’ fees.

In connection with any financing or refinancing of the Generating Facility by Seller, SCE shall in good faith work with Seller and Lender to agree upon a consent to collateral assignment of this Agreement (“Collateral Assignment Agreement”).

The Collateral Assignment Agreement must be in form and substance agreed to by SCE, Seller and Lender, and, unless otherwise agreed, must include, among others, the following provisions:

- (a) SCE shall give Notice of an Event of Default by Seller, to the person(s) to be specified by Lender in the Collateral Assignment Agreement, before exercising its right to terminate this Agreement as a result of such Event of Default;
- (b) Following an Event of Default by Seller under this Agreement, SCE may require Seller or Lender to provide to SCE a report concerning:
  - (i) The status of efforts by Seller or Lender to develop a plan to cure the Event of Default;
  - (ii) Impediments to the cure plan or its development;
  - (iii) If a cure plan has been adopted, the status of the cure plan's implementation (including any modifications to the plan as well as the expected timeframe within which any cure is expected to be implemented); and
  - (iv) Any other information which SCE may reasonably require related to the development, implementation and timetable of the cure plan.

Seller or Lender must provide the report to SCE within ten (10) Business Days after Notice from SCE requesting the report. SCE will have no further right to require the report with respect to a particular Event of Default after that Event of Default has been cured;

- (c) Lender will have the right to cure an Event of Default on behalf of Seller, only if Lender sends a written notice to SCE before the end of any cure period indicating Lender's intention to cure. Lender must remedy or cure the Event of Default within the cure period under this Agreement; *provided*, such cure period may, in SCE's sole discretion, be extended by no more than an additional one hundred eighty (180) days;
- (d) Lender will receive prior Notice of and the right to approve material amendments to this Agreement, which approval will not be unreasonably withheld, delayed or conditioned;
- (e) If Lender, directly or indirectly, takes possession of, or title to the Generating Facility (including possession by a receiver or title by foreclosure or deed in lieu of foreclosure), Lender must assume all of Seller's obligations arising under this Agreement and all related agreements (subject to such limits on liability as are mutually agreed to by Seller, SCE and Lender as set forth in the Collateral Assignment Agreement); *provided*, before such assumption, if SCE advises Lender that SCE will require that Lender cure (or cause to be cured) any Event of Default existing as of the possession date in order to avoid the exercise by SCE (in its sole discretion) of SCE's right to terminate this Agreement with respect to

*The contents of this document are subject to restrictions on disclosure as set forth herein.*

such Event of Default, then Lender at its option, and in its sole discretion, may elect to either:

- (i) Cause such Event of Default to be cured, or
  - (ii) Not assume this Agreement;
- (f) If Lender elects to sell or transfer the Generating Facility (after Lender directly or indirectly, takes possession of, or title to the Generating Facility), or sale of the Generating Facility occurs through the actions of Lender (for example, a foreclosure sale where a third party is the buyer, or otherwise), then Lender must cause the transferee or buyer to assume all of Seller's obligations arising under this Agreement and all related agreements as a condition of the sale or transfer.

Such sale or transfer may be made only to an entity with a tangible net worth of at least Fourteen Million dollars (\$14,000,000) and at least three (3) years of experience operating a generating plant of similar technology and similar size; and

- (g) If this Agreement is rejected in Seller's Bankruptcy or otherwise terminated in connection therewith and if Lender or its designee, directly or indirectly, takes possession of, or title to, the Generating Facility (including possession by a receiver or title by foreclosure or deed in lieu of foreclosure), Lender must itself or must cause its designee to promptly enter into a new agreement with SCE having substantially the same terms as this Agreement.

#### 10.06 Abandonment.

Seller may not relinquish its possession and control of the Generating Facility without the prior written consent of SCE except under circumstances provided for in Sections 10.04 and 10.05.

For purposes of this Section 10.06, Seller will have been deemed to relinquish possession of the Generating Facility if Seller has ceased all activities related to Operation of the Generating Facility for a consecutive thirty (30) day period and such cessation is not a result of Force Majeure.

#### 10.07 Governing Law.

THIS AGREEMENT AND THE RIGHTS AND DUTIES OF THE PARTIES HEREUNDER SHALL BE GOVERNED BY AND CONSTRUED, ENFORCED AND PERFORMED IN ACCORDANCE WITH THE LAWS OF THE STATE OF CALIFORNIA, WITHOUT REGARD TO PRINCIPLES OF CONFLICTS OF LAW. TO THE EXTENT ENFORCEABLE AT SUCH TIME, EACH PARTY WAIVES ITS RESPECTIVE RIGHT TO ANY JURY TRIAL WITH RESPECT TO ANY LITIGATION ARISING UNDER OR IN CONNECTION WITH THIS AGREEMENT.

#### 10.08 Notices.

All notices, requests, invoices, statements or payments must be made as specified in Exhibit C.

Notices (other than Forecasts, scheduling requests and curtailment (or equivalent) instructions) must, unless otherwise specified herein, be in writing and may be delivered by hand delivery, first class United States mail, overnight courier service, e-mail or facsimile. Notices of curtailment (or equivalent orders) may be oral or written and must be made in accordance with accepted industry practices for such notices.

Notice provided in accordance with this Section 10.08 will be deemed given as follows:

- (a) Notice by e-mail, facsimile or hand delivery will be deemed given at the close of business on the day actually received, if received during business hours on a Business Day, and otherwise will be deemed given at the close of business on the next Business Day;
- (b) Notice by overnight United States mail or courier service will be deemed given on the next Business Day after such Notice was sent out;
- (c) Notice by first class United States mail will be deemed given two (2) Business Days after the postmarked date;
- (d) Notice of curtailment will be deemed given on the date and time made by SCE and will be effective immediately.

Notices will be effective on the date deemed given, unless a different date for the Notice to go into effect is stated in another section of this Agreement.

A Party may change its designated representatives, addresses and other contact information by providing Notice of same in accordance herewith.

All Notices, requests, invoices, statements or payments related to this Agreement or the Generating Facility must reference the RAP ID and clearly identify the fact, circumstance, request, issue, dispute or matter to which such Notice relates.

#### 10.09 General.

- (a) This Agreement constitutes the entire agreement between the Parties relating to its subject matter.
- (b) This Agreement will be considered for all purposes as prepared through the joint efforts of the Parties and may not be construed against one Party or the other as a result of the preparation, substitution, submission or other event of negotiation, drafting or execution hereof.
- (c) Except to the extent provided for herein, no amendment or modification to this Agreement will be enforceable unless reduced to a writing signed by all Parties.
- (d) This Agreement does not impart any rights enforceable by any third party (other than a permitted successor or assignee bound to this Agreement).

*The contents of this document are subject to restrictions on disclosure as set forth herein.*



- (e) Waiver by a Party of any default by the other Party may not be construed as a waiver of any other default.
- (f) The term “including” when used in this Agreement is by way of example only and may not be considered in any way to be in limitation.
- (g) The word “or” when used in this Agreement includes the meaning “and/or” unless the context unambiguously dictates otherwise.
- (h) The headings used in this Agreement are for convenience and reference purposes only. Words having well-known technical or industry meanings have these meanings unless otherwise specifically defined in this Agreement.
- (i) Where days are not specifically designated as Business Days, they will be considered as calendar days.
- (j) This Agreement is binding on each Party’s successors and permitted assigns.
- (k) No provision of this Agreement is intended to contradict or supersede any agreement or Applicable Laws covering transmission, distribution, metering, scheduling or interconnection, including the interconnection agreement or the CAISO Tariff. In the event of an apparent contradiction between this Agreement and any such agreement or Applicable Laws, such agreement or Applicable Law controls.
- (l) Whenever this Agreement specifically refers to any law, tariff, government department or agency, regional reliability council, Transmission Provider, or credit rating agency, the Parties hereby agree that the reference also refers to any successor to such law, tariff or organization.
- (m) SCE has assigned a RAP ID number to this Agreement for tracking purposes only.
- (n) The Parties acknowledge and agree that this Agreement and the transactions contemplated by this Agreement constitute a “forward contract” within the meaning of the Bankruptcy Code and that SCE and Seller are each “forward contract merchants” within the meaning of the Bankruptcy Code.
- (o) This Agreement may be executed in one or more counterparts, each of which will be deemed to be an original of this Agreement and all of which, when taken together, will be deemed to constitute one and the same agreement. The exchange of copies of this Agreement and of signature pages by facsimile transmission, Portable Document Format (i.e., PDF) or by other electronic means constitutes effective execution and delivery of this Agreement as to the Parties and may be used in lieu of the original Agreement for all purposes.
- (p) Each Party shall act in good faith in its performance under this Agreement.
- (q) All dollar amounts set forth in this Agreement are in U.S. dollars.

#### 10.10 Confidentiality.

*The contents of this document are subject to restrictions on disclosure as set forth herein.*

(a) Terms and Conditions of this Agreement.

Neither Party shall disclose Confidential Information to a third party, other than:

- (i) To such Party's, or its upstream parents' (which, in the case of SCE, is Edison International), employees, Lenders, counsel, accountants, advisors or investors, in each case who have a need to know such information and have agreed to keep such terms confidential;
- (ii) To potential Lenders with the consent of SCE, which consent will not be unreasonably withheld;
- (iii) By either Party (the "Disclosing Party"), to participants of SCE's Procurement Review Group, as defined in CPUC Decision 02-08-071, subject to any confidentiality agreements or laws, regulations or regulatory decisions concerning confidentiality which are applicable to SCE's Procurement Review Group; *provided*, Seller may only disclose to such entities Confidential Information that is information on the bid and negotiation process of SCE's RPS solicitation; *provided further*, with respect to non-CPUC PRG participants, neither Party may disclose Confidential Information to such third parties unless and until a written confidentiality or non-disclosure agreement is fully executed between the Disclosing Party and such third-party disclosee. Seller shall provide Notice to SCE of any disclosure by Seller of Confidential Information pursuant to this Section 10.10(a)(iii) of this Agreement.
- (iv) By either Party, to the CPUC under seal for purposes of review subject to such Disclosing Party making reasonable efforts to obtain confidentiality protection from the CPUC under Section 583 of the California Public Utilities Code or other statute, order or rule offering comparable confidentiality protection; *provided*, except as set forth in Sections 10.10(a)(vii), 10.10(a)(viii) and 10.10(b), as applicable, Seller may only disclose to the CPUC Confidential Information that is information on the bid and negotiation process of SCE's RPS solicitation. Seller shall provide Notice to SCE of any disclosure by Seller of Confidential Information pursuant to this Section 10.10(a)(iv) of this Agreement.
- (v) To the CAISO or as otherwise may reasonably be required in order to participate in any auction, market or other process pertaining to the allocation of priorities or rights related to the transmission of electric energy sold or to be sold to SCE hereunder;
- (vi) In order to comply with any Applicable Law or any exchange, control area or CAISO rule, or order issued by a court or entity with competent jurisdiction over the Disclosing Party, other than to those entities set forth in Section 10.10(a)(vii);

*The contents of this document are subject to restrictions on disclosure as set forth herein.*

- (vii) In order to comply with any applicable regulation, rule, or order of the CPUC, CEC, FERC, any court, administrative agency, legislative body or other tribunal, or any mandatory discovery or data request of a party to any proceeding pending before any of the foregoing;
- (viii) To any governmental body, the CPUC, the CAISO or any local control area or regional authority having jurisdiction in order to support SCE's Resource Adequacy Requirement showings, if applicable; *provided*, SCE shall, to the extent reasonable, use reasonable efforts to limit the ability of any such applicable governmental body, CAISO, local control area or regional authority to further disclose such information;
- (ix) As may reasonably be required to participate in the WREGIS or other process recognized under Applicable Laws for the registration, transfer or ownership of Green Attributes associated with the Generating Facility;
- (x) To representatives of a Party's credit ratings agencies:
  - (1) Who have a need to review the terms and conditions of this Agreement for the purpose of assisting the Party in evaluating this Agreement for credit rating purposes and have agreed to keep this information confidential; or
  - (2) With respect to the potential impact of this Agreement on the Party's financial reporting obligations;
- (xi) Disclosure of terms specified in and pursuant to Section 10.10(c);
- (xii) In connection with discovery requests or orders pertaining to the non-public terms of this Agreement as referenced in Sections 10.10(a)(vi) and 10.10(a)(vii) ("Disclosure Order") each Party shall, to the extent practicable, use reasonable efforts to:
  - (1) Notify the other Party before disclosing the Confidential Information; and
  - (2) Prevent or limit such disclosure.After using such reasonable efforts, the Disclosing Party will not be:
  - (3) Prohibited from complying with a Disclosure Order; or
  - (4) Liable to the other Party for monetary or other damages incurred in connection with the disclosure of the Confidential Information.Except as provided in the preceding sentence, the Parties are entitled to all remedies available at law or in equity to enforce, or seek relief in connection with this confidentiality obligation.

(b) Non-Disclosure Agreement.

- (i) The Parties acknowledge and agree that information provided by the Parties pursuant to this Agreement will be subject to the Non-Disclosure Agreement, or to any other agreement that the Parties negotiate to provide reasonable protection for their confidential business information or trade secrets.
- (ii) Confidential Information may only be used for the purposes set forth under the Non-Disclosure Agreement and for the purpose of implementing and enforcing this Agreement.

(c) RPS Confidentiality.

Notwithstanding Section 10.10(a), at any time on or after the Effective Date, either Party shall be permitted to disclose the following terms with respect to this Agreement:

- (i) Party names;
- (ii) ERR type;
- (iii) Term;
- (iv) Generating Facility location;
- (v) Contract Capacity;
- (vi) Forecasted Commercial Operation Date;
- (vii) Delivery Point; and
- (viii) Generating Facility's expected energy deliveries.

10.11 Insurance.

- (a) Starting on the Effective Date and throughout the Delivery Term of this Agreement and for such additional periods as may be specified below, Seller, and to the extent not covered by the Seller's insurance policies, its contractors and subcontractors, shall, at their own expense, provide and maintain in effect the insurance policies and minimum limits of coverage specified below, and such additional coverage as may be required by applicable law, with insurance companies which are authorized to do business in the state in which the services are to be performed and which have an A.M. Best's Insurance Rating of not less than A-:VII. The minimum insurance requirements specified herein do not in any way limit or relieve Seller of any obligation assumed elsewhere in this Agreement, including, but not limited to, Seller's defense and indemnity obligations.
  - (i) Workers' Compensation Insurance with the statutory limits required by the state having jurisdiction over Seller's employees;
  - (ii) Employer's Liability Insurance with limits of not less than:

*The contents of this document are subject to restrictions on disclosure as set forth herein.*

- (1) Bodily injury by accident – One Million dollars (\$1,000,000) each accident
  - (2) Bodily injury by disease – One Million dollars (\$1,000,000) policy limit
  - (3) Bodily injury by disease – One Million dollars (\$1,000,000) each employee
- (iii) Commercial General Liability Insurance, (which, except with the prior written consent of SCE and subject to subsections 10.11(a)(iii)(1) and 10.11(a)(iii)(2) below, shall be written on an “occurrence,” not a “claims-made” basis), covering all operations by or on behalf of Seller arising out of or connected with this Agreement, including coverage for bodily injury, property damage, personal and advertising injury, products/completed operations, and contractual liability. Such insurance shall bear a per occurrence limit of not less than One Million dollars (\$1,000,000), and annual aggregate of not less than Two Million dollars (\$2,000,000), exclusive of defense costs, for all coverages. Such insurance shall contain standard cross-liability and severability of interest provisions.

If Seller elects, with SCE’s written concurrence, to use a “claims made” form of Commercial General Liability Insurance, then the following additional requirements apply:

- (1) The retroactive date of the policy must be prior to the Effective Date; and
  - (2) Either the coverage must be maintained for a period of not less than four (4) years after the Agreement terminates, or the policy must provide for an extended reporting period of not less than four (4) years after the Agreement terminates.
- (iv) Commercial Automobile Liability Insurance covering bodily injury and property damage with a combined single limit of not less than One Million dollars (\$1,000,000) per occurrence. Such insurance shall cover liability arising out of Seller’s use of all owned (if any), non-owned and hired vehicles, including trailers or semi-trailers in the performance of the Agreement.
- (v) Pollution Liability Insurance, (which, except with the prior written consent of SCE and subject to subsections 10.11(a)(v)(1) and 10.11(a)(v)(2) below, shall be written on an “occurrence,” not a “claims-made” basis) with limits of not less than Five Million dollars (\$5,000,000) per occurrence or each claim and in the annual aggregate, covering losses involving hazardous material(s) and caused by pollution incidents or conditions that arise from the operations of the Seller, including but not limited to, coverage for bodily injury, sickness, disease, mental anguish or

*The contents of this document are subject to restrictions on disclosure as set forth herein.*

shock sustained by any person, including death, property damage including the resulting loss of use thereof, clean-up costs, and the loss of use of tangible property that has not been physically damaged or destroyed, and defense costs.

If Seller elects, with SCE's written concurrence, to use a "claims made" form of Commercial General Liability Insurance, then the following additional requirements apply:

- (1) The retroactive date of the policy must be prior to the Effective Date; and
- (2) Either the coverage must be maintained for a period of not less than three (3) years after the Agreement terminates, or the policy must provide for an extended reporting period of not less than three (3) years after the Agreement terminates.

- (vi) Umbrella/Excess Liability Insurance, written on an "occurrence," not a "claims-made" basis, providing coverage excess of the underlying Employer's Liability, Commercial General Liability, Commercial Automobile Liability and Pollution Liability insurance, on terms at least as broad as the underlying coverage, with limits of not less than Twenty Million dollars (\$20,000,000) per occurrence and in the annual aggregate. The insurance requirements of this Section 10.11 can be provided by any combination of Seller's primary and excess liability policies.

If Seller elects, with SCE's written concurrence, to use a "claims made" form of Umbrella/Excess Liability Insurance, then the following additional requirements apply:

- (1) The retroactive date of the policy must be prior to the Effective Date; and
- (2) Either the coverage must be maintained for a period of not less than three (3) years after the Agreement terminates, or the policy must provide for an extended reporting period of not less than three (3) years after the Agreement terminates.

- (b) The insurance required above shall apply as primary insurance to, without a right of contribution from, any other insurance maintained by or afforded to SCE, its subsidiaries and affiliates, and their respective officers, directors, shareholders, agents, and employees, regardless of any conflicting provision in Seller's policies to the contrary. To the extent permitted by law, Seller and its insurers shall be required to waive all rights of recovery from or subrogation against SCE, its subsidiaries and affiliates, and their respective officers, directors, shareholders, agents, employees and insurers. The Commercial General Liability, the Commercial Automobile Liability Policy, the Pollution Liability and the Umbrella/Excess Liability insurance required above shall include, either by policy

*The contents of this document are subject to restrictions on disclosure as set forth herein.*

terms and conditions or by endorsement, SCE, its parent, subsidiaries and affiliates, and their respective officers, directors, shareholders, agents and employees, assigns, and successors in interest, as additional insureds for liability arising out of Seller's construction, ownership or Operation of the Generating Facility, or obligations or performance, under this Agreement.

- (c) All policies required by Sections 10.11(a)(i) through 10.11(a)(vi) shall be written on a "per project" or "per contract" basis.
- (d) Within ten (10) Business Days after the Effective Date, and within ten (10) Business Days after coverage is renewed or replaced, Seller shall furnish to SCE the entire policy forms, including endorsements, and certificates of insurance evidencing the coverage required above, written on forms and with deductibles reasonably acceptable to SCE. All deductibles and co-insurance retentions applicable to the insurance above shall be paid by Seller. Seller, or its insurance broker or agent, shall provide SCE with at least thirty (30) days' prior written notice in the event of cancellation of coverage. SCE's receipt of certificates that do not comply with the requirements stated herein, or Seller's failure to provide certificates, shall not limit or relieve Seller of the duties and responsibility of maintaining insurance in compliance with the requirements in this Section 10.11 and shall not constitute a waiver of any of the requirements in this Section 10.11.
- (e) Seller agrees to report to SCE in writing within ten (10) Business Days following all accidents or occurrences resulting in bodily injury to any person, and to any property where such property damage is greater than One Hundred Thousand dollars (\$100,000.00).
- (f) If Seller fails to comply with any of the provisions of this Section 10.11, Seller, among other things and without restricting SCE's remedies under the law or otherwise, shall, at its own cost and expense, act as an insurer and provide insurance in accordance with the terms and conditions above. With respect to the required Commercial General Liability, Umbrella/Excess Liability, Pollution Liability and Commercial Automobile Liability insurance, Seller shall provide a current, full and complete defense to SCE, its subsidiaries and affiliates, and their respective officers, directors, shareholders, agents, employees, assigns, and successors in interest, in response to a third-party claim in the same manner that an insurer would have, had the insurance been maintained in accordance with the terms and conditions set forth above. In addition, alleged violations of the provisions of this Section 10.11 means that Seller has the initial burden of proof regarding any legal justification for refusing or withholding coverage and Seller shall face the same liability and damages as an insurer for wrongfully refusing or withholding coverage in accordance with the laws of California.

#### 10.12 Nondedication.

Notwithstanding any other provisions of this Agreement, neither Party dedicates any of the rights that are or may be derived from this Agreement or any part of its facilities

*The contents of this document are subject to restrictions on disclosure as set forth herein.*

involved in the performance of this Agreement to the public or to the service provided under this Agreement, and this service shall cease upon termination of this Agreement.

#### 10.13 Mobile Sierra.

Absent the agreement of all Parties to the proposed change, the standard of review for changes to any rate, charge, classification, term or condition of this Agreement, whether proposed by a Party (to the extent that any waiver in the next paragraph below is unenforceable or ineffective as to such Party), a non-party or FERC acting sua sponte, shall be the ‘public interest’ standard of review set forth in United Gas Pipe Line Co. v. Mobile Gas Service Corp., 350 U.S. 332 (1956) and Federal Power Commission v. Sierra Pacific Power Co., 350 U.S. 348 (1956), and clarified by Morgan Stanley Capital Group, Inc. v. Public Util. Dist. No. 1 of Snohomish 554 U.S. 527 (2008).

Notwithstanding any provision of Agreement, and absent the prior written agreement of the Parties, each Party, to the fullest extent permitted by Applicable Laws, for itself and its respective successors and assigns, hereby also expressly and irrevocably waives any rights it can or may have, now or in the future, whether under Sections 205, 206, or 306 of the Federal Power Act or otherwise, to seek to obtain from FERC by any means, directly or indirectly (through complaint, investigation, supporting a third party seeking to obtain or otherwise), and each hereby covenants and agrees not at any time to seek to so obtain, an order from FERC changing any Section of this Agreement specifying any rate or other material economic terms and conditions agreed to by the Parties.

#### 10.14 Simple Interest Payments.

Except as specifically provided in this Agreement, any outstanding and past due amounts owing and unpaid by either Party under the terms of this Agreement will be eligible to receive a Simple Interest Payment calculated using the Interest Rate for the number of days between the date due and the date paid.

#### 10.15 Payments.

Payments to be made under this Agreement must be made by wire transfer.

#### 10.16 Seller Ownership and Control of Generating Facility.

Seller agrees, that, in accordance with FERC Order No. 697, upon request of SCE, Seller shall submit a letter of concurrence in support of any affirmative statement by SCE that the contractual arrangement set forth in this Agreement does not transfer “ownership or control of generation capacity” from Seller to SCE as the term “ownership or control of generation capacity” is used in 18 CFR Section 35.42. Seller also agrees that it will not, in filings, if any, made subject to FERC Order Nos. 652 and 697, claim that the contractual arrangement set forth in this Agreement conveys ownership or control of generation capacity from Seller to SCE.

#### 10.17 Required Material.

*The contents of this document are subject to restrictions on disclosure as set forth herein.*



Seller acknowledges and agrees that, notwithstanding anything to the contrary set forth herein, any review, approval, request, or requirement of any Required Material shall mean only that such Required Material is acceptable to SCE solely for SCE's internal purposes and benefit, and will not in any way be construed to mean that such Required Material is accurate, suitable for its intended purpose, in compliance with any Applicable Law or other requirement, or endorsed for the benefit of any other party, including Seller. Further, Seller acknowledges and agrees that SCE shall have no liability to Seller or any other third party with respect to any Required Material so reviewed, approved, requested or required by SCE or on SCE's behalf.

---

\*\*\* End of ARTICLE TEN \*\*\*

## **ARTICLE ELEVEN. CHANGE IN ELECTRIC MARKET DESIGN**

If a Change in CAISO Tariff renders this Agreement or any terms herein incapable of being performed or administered, then either Party, on Notice, may request the other Party to enter into negotiations to make the minimum changes to this Agreement necessary to make this Agreement capable of being performed and administered, while attempting to preserve to the maximum extent possible the benefits, burdens and obligations set forth in this Agreement as of the Effective Date.

Upon receipt of a Notice requesting negotiations, the Parties shall negotiate in good faith.

If the Parties are unable, within sixty (60) days after the sending of the Notice requesting negotiations, either to agree upon changes to this Agreement or to resolve issues relating to changes to this Agreement, then either Party may submit issues pertaining to changes to this Agreement to mediation and arbitration as provided in Article Twelve.

A change in cost will not in itself be deemed to render this Agreement or any terms therein incapable of being performed or administered, or constitute, or form the basis of, a Force Majeure event.

---

\*\*\* End of ARTICLE ELEVEN \*\*\*

**ARTICLE TWELVE. MEDIATION AND ARBITRATION****12.01 Dispute Resolution.**

Other than requests for provisional relief under Section 12.04, any and all Disputes which the Parties have been unable to resolve by informal methods after undertaking a good faith effort to do so, must first be submitted to mediation under the procedures described in Section 12.02 below, and if the matter is not resolved through mediation, *then* for final and binding arbitration under the procedures described in Section 12.03 below.

The Parties waive any right to a jury and agree that there will be no interlocutory appellate relief (such as writs) available. Any Dispute resolution process shall be commenced no later than one (1) year from the date the Dispute occurred; *provided*, if the facts giving rise to the Dispute were not reasonably capable of being discovered at the time of their occurrence, then no later than one (1) year from the earliest date that such facts were reasonably capable of being discovered, and in no event more than four (4) years after the Dispute occurred. If any Dispute resolution process pursuant to Article Twelve with respect to a Dispute is not commenced within such one (1) year time period, such Dispute shall be waived and forever barred, without regard to any other limitations period set forth by law or statute.

**12.02 Mediation.**

Either Party may initiate mediation by providing Notice to the other Party in accordance with Section 10.08 of a written request for mediation, setting forth a description of the Dispute and the relief requested.

The Parties will cooperate with one another in selecting the mediator (“Mediator”) from the panel of neutrals from Judicial Arbitration and Mediation Services, Inc. (“JAMS”), its successor, or any other mutually acceptable non-JAMS Mediator, and in scheduling the time and place of the mediation.

Such selection and scheduling will be completed within forty-five (45) days after Notice of the request for mediation.

Unless otherwise agreed to by the Parties, the mediation will not be scheduled for a date that is greater than one hundred twenty (120) days from the date of Notice of the request for mediation.

The Parties covenant that they will participate in the mediation in good faith, and that they will share equally in its costs (other than each Party’s individual attorneys’ fees and costs related to the Party’s participation in the mediation, which fees and costs will be borne by such Party).

All offers, promises, conduct and statements, whether oral or written, made in connection with or during the mediation by either of the Parties, their agents, representatives, employees, experts and attorneys, and by the Mediator or any of the Mediator’s agents, representatives and employees, will not be subject to discovery and will be confidential, privileged and inadmissible for any purpose, including impeachment, in any arbitration or

other proceeding between or involving the Parties, or either of them, *provided*, evidence that is otherwise admissible or discoverable will not be rendered inadmissible or non-discoverable as a result of its use in the mediation.

### 12.03 Arbitration.

Either Party may initiate binding arbitration with respect to the matters first submitted to mediation by providing Notice in accordance with Section 10.08 of a demand for binding arbitration before a single, neutral arbitrator (the “Arbitrator”) within sixty (60) days following the unsuccessful conclusion of the mediation provided for in Section 12.02, above. If Notice of arbitration is not provided by either Party within sixty (60) days following the unsuccessful conclusion of the mediation provided for in Section 12.02 above, the Dispute resolution process shall be deemed complete and further resolution of such Dispute shall be barred, without regard to any other limitations period set forth by law or statute.

The Parties will cooperate with one another in selecting the Arbitrator within sixty (60) days after Notice of the demand for arbitration and will further cooperate in scheduling the arbitration to commence no later than one hundred eighty (180) days from the date of Notice of the demand.

If, notwithstanding their good faith efforts, the Parties are unable to agree upon a mutually-acceptable Arbitrator, the Arbitrator will be appointed as provided for in California Code of Civil Procedure Section 1281.6.

To be qualified as an Arbitrator, each candidate must be a retired judge of a trial court of any state or federal court, or retired justice of any appellate or supreme court.

Unless otherwise agreed to by the Parties, the individual acting as the Mediator will be disqualified from serving as the Arbitrator in the dispute, although the Arbitrator may be another member of the JAMS panel of neutrals or such other panel of neutrals from which the Parties have agreed to select the Mediator.

Upon Notice of a Party’s demand for binding arbitration, such Dispute submitted to arbitration, including the determination of the scope or applicability of this agreement to arbitrate, will be determined by binding arbitration before the Arbitrator, in accordance with the laws of the State of California, without regard to principles of conflicts of laws.

Except as provided for herein, the arbitration will be conducted by the Arbitrator in accordance with the rules and procedures for arbitration of complex business disputes for the organization with which the Arbitrator is associated.

Absent the existence of such rules and procedures, the arbitration will be conducted in accordance with the California Arbitration Act, California Code of Civil Procedure Section 1280 *et seq.* and California procedural law (including the Code of Civil Procedure, Civil Code, Evidence Code and Rules of Court, but excluding local rules).

Notwithstanding the rules and procedures that would otherwise apply to the arbitration, and unless the Parties agree to a different arrangement, the place of the arbitration will be in Los Angeles County, California.

Also notwithstanding the rules and procedures that would otherwise apply to the arbitration, and unless the Parties agree to a different arrangement, discovery will be limited as follows:

- (a) Before discovery commences, the Parties shall exchange an initial disclosure of all documents and percipient witnesses which they intend to rely upon or use at any arbitration proceeding (except for documents and witnesses to be used solely for impeachment);
- (b) The initial disclosure will occur within thirty (30) days after the initial conference with the Arbitrator or at such time as the Arbitrator may order;
- (c) Discovery may commence at any time after the Parties' initial disclosure;
- (d) The Parties will not be permitted to propound any interrogatories or requests for admissions;
- (e) Discovery will be limited to twenty-five (25) document requests (with no subparts), three (3) lay witness depositions, and three (3) expert witness depositions (unless the Arbitrator holds otherwise following a showing by the Party seeking the additional documents or depositions that the documents or depositions are critical for a fair resolution of the Dispute or that a Party has improperly withheld documents);
- (f) Each Party is allowed a maximum of three (3) expert witnesses, excluding rebuttal experts;
- (g) Within sixty (60) days after the initial disclosure, or at such other time as the Arbitrator may order, the Parties shall exchange a list of all experts upon which they intend to rely at the arbitration proceeding;
- (h) Within thirty (30) days after the initial expert disclosure, the Parties may designate a maximum of two (2) rebuttal experts;
- (i) Unless the Parties agree otherwise, all direct testimony will be in form of affidavits or declarations under penalty of perjury; and
- (j) Each Party shall make available for cross examination at the arbitration hearing its witnesses whose direct testimony has been so submitted.

Subject to Article Seven, the Arbitrator will have the authority to grant any form of equitable or legal relief a Party might recover in a court action. The Parties acknowledge and agree that irreparable damage would occur if certain provisions of this Agreement are not performed in accordance with the terms of the Agreement, that money damages would not be a sufficient remedy for any breach of these provisions of this Agreement, and that the Parties shall be entitled, without the requirement of posting a bond or other

security, to specific performance and injunctive or other equitable relief as a remedy for a breach of Section 2.04(b), 3.01, 3.02, 3.06(h), 3.09 or 10.10 of this Agreement.

Judgment on the award may be entered in any court having jurisdiction.

The Arbitrator must, in any award, allocate all of the costs of the binding arbitration (other than each Party's individual attorneys' fees and costs related to the Party's participation in the arbitration, which fees and costs will be borne by such Party), including the fees of the Arbitrator and any expert witnesses, against the Party who did not prevail.

Until such award is made, however, the Parties will share equally in paying the costs of the arbitration.

At the conclusion of the arbitration hearing, the Arbitrator shall prepare in writing and provide to each Party a decision setting forth factual findings, legal analysis, and the reasons on which the Arbitrator's decision is based. The Arbitrator shall also have the authority to resolve claims or issues in advance of the arbitration hearing that would be appropriate for a California superior court judge to resolve in advance of trial. The Arbitrator shall not have the power to commit errors of law or fact, or to commit any abuse of discretion, that would constitute reversible error had the decision been rendered by a California superior court. The Arbitrator's decision may be vacated or corrected on appeal to a California court of competent jurisdiction for such error. Unless otherwise agreed to by the Parties, all proceedings before the Arbitrator shall be reported and transcribed by a certified court reporter, with each Party bearing one-half of the court reporter's fees.

#### 12.04 Provisional Relief.

The Parties acknowledge and agree that irreparable damage would occur if certain provisions of this Agreement are not performed in accordance with the terms of this Agreement, that money damages would not be a sufficient remedy for any breach of these provisions of this Agreement, and that the Parties shall be entitled, without the requirement of posting a bond or other security, to seek a preliminary injunction, temporary restraining order, or other provisional relief as a remedy for a breach of Section 2.04(b), 3.01, 3.02, 3.06(h), 3.09 or 10.10 of this Agreement in any court of competent jurisdiction, notwithstanding the obligation to submit all other disputes (including all claims for monetary damages under this Agreement) to arbitration pursuant to Section 12.01. The Parties further acknowledge and agree that the results of the arbitration may be rendered ineffectual without the provisional relief.

Such a request for provisional relief does not waive a Party's right to seek other remedies for the breach of the provisions specified above in accordance with Section 12.01, notwithstanding any prohibition against claim-splitting or other similar doctrine. The other remedies that may be sought include specific performance and injunctive or other equitable relief, plus any other remedy specified in this Agreement for the breach of the provision, or if the Agreement does not specify a remedy for the breach, all other remedies available at law or equity to the Parties for the breach.

*\*\*\* End of ARTICLE TWELVE \*\*\**

In WITNESS WHEREOF, the Parties have caused this Agreement to be duly executed as of the Effective Date first written:

**PACIFIC ULTRAPOWERS CHINESE STATION,**

**SOUTHERN CALIFORNIA EDISON COMPANY,**

a California General Partnership.

a California corporation.

By:

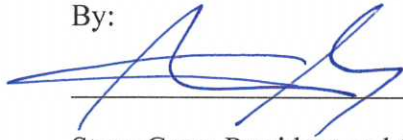
  
\_\_\_\_\_

By:

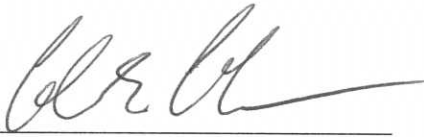
  
\_\_\_\_\_

Steve Gross President and CEO

Colin Cushnie

General Manager, IPGC Chinese Station Inc., a Maryland Corporation

Vice President, Power Procurement

Date: 10/11/16

Date: 10/18/16



**EXHIBITS**

**EXHIBIT A***Definitions*

The following terms shall have the following meaning for purposes of this Agreement.

“AC” means alternating current.

“Accepted Compliance Costs” has the meaning set forth in Section 1.08.

“Account Holder” has the meaning set forth in the WREGIS Operating Rules, as applicable to the Generating Facility as the Registered Generating Unit.

“Actual Availability Report” means a report to be prepared by Seller in the form of Exhibit N containing the information described in Section 3.22.

“Actual Available Capacity” means the sum of the capacity, in MWs, of all generating units of the Generating Facility that were available at the end of the Settlement Interval, as indicated by the Actual Availability Report.

“Affiliate” means, with respect to a Party, any entity that, directly or indirectly, through one or more intermediaries, controls, or is controlled by, or is under common control with that Party.

“Aggregate Network Upgrade Costs” has the meaning set forth in Section 2.03(b)(i).

“Agreement” has the meaning set forth in the Preamble.

“Applicable Laws” means all constitutions, treaties, laws, ordinances, rules, regulations, interpretations, permits, judgments, decrees, injunctions, writs and orders of any Governmental Authority that apply to either or both of the Parties, the Generating Facility or the terms of this Agreement.

“Arbitrator” has the meaning set forth in Article Twelve.

“Availability Incentive Payments” has the meaning set forth in the CAISO Tariff.

“Availability Standards” has the meaning set forth in the CAISO Tariff.

“Availability Workbook” has the meaning set forth in Exhibit N.

“Bankrupt” means with respect to any entity, such entity:

- (a) Files a petition or otherwise commences, authorizes or acquiesces in the commencement of a proceeding or cause of action under any bankruptcy, insolvency, reorganization or similar law, or has any such petition filed or commenced against it;

*The contents of this document are subject to restrictions on disclosure as set forth herein.*

---

- (b) Makes an assignment or any general arrangement for the benefit of creditors;
- (c) Otherwise becomes bankrupt or insolvent (however evidenced);
- (d) Has a liquidator, administrator, receiver, trustee, conservator or similar official appointed with respect to such entity or any substantial portion of its property or assets; or
- (e) Is generally unable to pay its debts as they fall due.

“Bankruptcy Code” means the United States Bankruptcy Code (11 U.S.C. §101 *et seq.*), as amended, and any successor statute.

“Bid” has the meaning as set forth in the CAISO Tariff.

“Business Day” means any day except a Saturday, Sunday, a Federal Reserve Bank holiday, or the Friday following Thanksgiving. A Business Day begins at 8:00 a.m. and end at 5:00 p.m. local time for the Party sending the Notice or payment or performing a specified action.

“Business Practice Manuals” or “BPMs” has the meaning as set forth in the CAISO Tariff.

“Buyer” means Southern California Edison Company.

“CAISO” means the California Independent System Operator Corporation or successor entity.

“CAISO Approved Meter” means a CAISO approved revenue quality meter or meters, CAISO approved data processing gateway or remote intelligence gateway, telemetering equipment and data acquisition services sufficient for monitoring, recording and reporting, in real time, all electric energy produced by the Generating Facility less Station Use.

“CAISO-Controlled Grid” has the meaning as set forth in the CAISO Tariff.

“CAISO Costs” means the debits, costs, penalties and interest that are directly assigned by the CAISO to the CAISO Resource ID for the Generating Facility for, or attributable to, Scheduling or deliveries from the Generating Facility under this Agreement in each applicable Settlement Interval.

“CAISO Markets” has the meaning as set forth in the CAISO Tariff.

“CAISO Resource ID” means the number or name assigned by the CAISO to the CAISO Approved Meter.

“CAISO Revenues” means the credits and other payments incurred or received by SCE as a result of energy from the Generating Facility delivered to any CAISO administered market by Seller, including costs and revenues associated with CAISO dispatches, for each applicable Settlement Interval.

“CAISO Sanctions” means any sanctions directly assigned by the CAISO to Seller, the CAISO Resource ID or the Generating Facility.

“CAISO Tariff” means the California Independent System Operator Corporation Operating Agreement and Tariff, Business Practice Manuals (BPMs), and Operating Procedures, including the rules, protocols, procedures and standards attached thereto, as the same may be amended or modified from time-to-time and approved by FERC.

“Calculation Period” has the meaning set forth in Section 3.07(a)(i).

“California Renewables Portfolio Standard” means the California Public Utilities Code Section 399.11, *et seq.*

“Capacity Attributes” means any and all current or future defined characteristics, certificates, tags, credits, ancillary service attributes, or accounting constructs, howsoever entitled, including any accounting construct counted toward any Resource Adequacy Requirements, attributed to or associated with the Generating Facility or any unit of generating capacity of the Generating Facility throughout the Delivery Term, including:

- (a) resource adequacy attributes, as may be identified from time to time by the CPUC, CAISO, or other Governmental Authority having jurisdiction, that can be counted toward RAR;
- (b) resource adequacy attributes or other locational attributes for the Generating Facility related to a Local Capacity Area, as may be identified from time to time by the CPUC, CAISO or other Governmental Authority having jurisdiction, associated with the physical location or point of electrical interconnection of the Generating Facility within the CAISO-Controlled Grid, that can be counted toward a Local RAR; and
- (c) flexible capacity resource adequacy attributes for the Generating Facility, including, without limitation, the amount of EFC as may be identified from time to time by the CPUC, CAISO, or other Governmental Authority having jurisdiction, that can be counted toward Flexible RAR.

“Capacity Procurement Mechanism” or “CPM” has the meaning as set forth in the CAISO Tariff.

“CEC” means the California Energy Commission.

“CEC Certification” means certification by the CEC that the Generating Facility is an ERR for purposes of the RPS Legislation and that all electric energy produced by the Generating Facility qualifies as generation from an ERR for purposes of the RPS Legislation.

“CEC Pre-Certification” means provisional certification of the proposed Generating Facility as an ERR by the CEC upon submission by a facility of a complete CEC-RPS-1B application and required supplemental information.

“CEC Verification” means verification by the CEC based on ongoing reporting by Seller that the Generating Facility is an ERR for purposes of the RPS Legislation and that all electric energy produced by the Generating Facility qualifies as generation from an ERR for purposes of the RPS Legislation.

“CFR” means the Code of Federal Regulations, as may be amended from time to time.

“Change in CAISO Tariff” means that the CAISO Tariff has been changed and such change has a material adverse impact on either Party, or the CAISO has been dissolved or replaced and any successor to the CAISO operates under rules, protocols, procedures or standards that differ in a material respect from the CAISO Tariff, after the Effective Date.

“Check Meter” means the SCE revenue-quality meter section or meter, which SCE may require at its discretion, as set forth in Section 3.08(b), and which will include those devices normally supplied by SCE or Seller under the applicable utility electric service requirements.

“Claiming Party” has the meaning set forth in Section 5.02.

“Collateral Assignment Agreement” has the meaning set forth in Section 10.05.

“Commercial Operation” is the status of the Generating Facility upon Seller’s satisfaction of all of the conditions set forth in Section 2.02(b) and as of the Commercial Operation Date.

“Commercial Operation Date” has the meaning set forth in Section 2.02(b).

“Commercial Operation Deadline” has the meaning set forth in Section 1.03.

“Compliance Actions” has the meaning set forth in Section 1.08.

“Compliance Expenditure Cap” means the dollar amount set forth in Section 1.08.

“Confidential Information” shall mean (i) this Agreement, (ii) all oral or written communications exchanged between the Parties pursuant to this Agreement, except for communications and information described in Section 10.10(c) of this Agreement, and (iii) all oral or written communications exchanged between the Parties as part of, or arising out of, Seller’s Proposal (including the fact that Seller submitted a Proposal, and, the fact that SCE short-listed the Proposal).

“Construction Permits” means any permits issued by the Governmental Authority having jurisdiction that grant Seller the authority to develop and construct the Generating Facility on the Site. Construction Permits include conditional use permit and authority to construct.

“Contract Capacity” means the lesser of (i) the amount of electric energy generating capacity, set forth in Section 1.01(h), that Seller commits to install at the Site and (ii) the Demonstrated Contract Capacity.

“Control Area” means the electric power system (or combination of electric power systems) under the operational control of the CAISO or any other electric power system under the operational control of another organization vested with authority comparable to that of the CAISO.

“Costs” means, with respect to the Non-Defaulting Party, brokerage fees, commissions, legal expenses and other similar third-party transaction costs and expenses reasonably incurred by that Party in entering into any new arrangement which replaces this Agreement.

“CPUC” means the California Public Utilities Commission.

“CPUC Approval” means a final and non-appealable order of the CPUC, without conditions or modifications unacceptable to the Parties, or either of them, which contains the following terms:

- (a) Approves this Agreement in its entirety, including payments to be made by the Buyer, subject to CPUC review of the Buyer’s administration of the Agreement; and
- (b) Finds that any procurement pursuant to this Agreement is procurement from an eligible renewable energy resource for purposes of determining Buyer’s compliance with any obligation that it may have to procure eligible renewable energy resources pursuant to the California Renewables Portfolio Standard (Public Utilities Code Section 399.11 *et seq.*), Decision 03-06-071, or other applicable law.

CPUC Approval will be deemed to have occurred on the date that a CPUC decision containing such findings becomes final and non-appealable.

“Credit Rating” means with respect to any entity, on the relevant date of determination, the respective ratings then assigned to such entity’s unsecured, senior long-term debt or deposit obligations (not supported by third-party credit enhancement) by S&P, Fitch or Moody’s. If no rating is assigned to such entity’s unsecured, senior long-term debt or deposit obligation by S&P, Fitch or Moody’s, then “Credit Rating” means the general corporate credit rating or long-term issuer rating assigned by the other two ratings agencies.

“Curtailed Product” or “CP” means energy that could have been delivered to the Delivery Point by Seller but which was not delivered (i) due to Seller’s curtailment in accordance with Section 3.12(g)(iii), or (ii) if the CAISO Tariff prohibits, without any action by the CAISO or any Transmission Provider, any electric generating facilities from delivery of energy in excess of its Schedule, any such energy that the Generating Facility was precluded from delivering. The amount of energy that could have been delivered will be determined in accordance with Section 3.21 and Exhibit K.

“Curtailed Product Payment” means, in each month, the sum of all payments for Paid Curtailed Product.

“Curtailed Order” means an order from SCE to Seller to reduce or stop the delivery of electric energy from the Generating Facility to SCE for any reason except as set forth in Sections 3.12(g)(i)-(ii).

“Daily Delay Liquidated Damages” has the meaning set forth in Section 3.06(c).

“Defaulting Party” has the meaning set forth in Section 6.01.

“Delivery Network Upgrades” has the meaning set forth in the CAISO Tariff, as applicable to the Generating Facility.

“Delivery Point” means the point of delivery of Product to the CAISO-Controlled Grid, as specified in Section 1.01(f) and set forth in the single-line diagram of the CAISO-Controlled Grid interconnection set forth in Exhibit B.

“Delivery Term” means the period beginning with the Commercial Operation Date and continuing throughout the end of the Term.

“Demonstrated Contract Capacity” means the Generating Facility’s total rated electric alternating current energy generating capacity, which will equal the sum of the Metered Amounts for the Demonstration Hour, as determined in accordance with Exhibit J.

“Demonstration Hour” has the meaning set forth in Exhibit J.

“Development Security” has the meaning set forth in Section 3.06(a).

“Disclosing Party” has the meaning set forth in Section 10.10.

“Disclosure Order” has the meaning set forth in Section 10.10.

“Dispatch Instruction” has the meaning set forth in the CAISO Tariff.

“Dispute” means any and all disputes, claims or controversies arising out of, relating to, concerning or pertaining to the terms of this Agreement, or to either Party’s performance or failure of performance under this Agreement.

“Disqualified Stock” means any capital stock that, by its terms (or by the terms of any security into which such stock is convertible, or for which such stock is exchangeable, in each case at the option of the holder of the capital stock), or upon the happening of any event, matures or is mandatorily redeemable, pursuant to a sinking fund obligation or otherwise, or is redeemable at the option of the holder of the capital stock, in whole or in part, on or before the date that is ninety-one (91) days after the expiration of the Term of this Agreement.

“Diverse Business Enterprises” means a women, minority, disabled veteran, lesbian, gay, bisexual and /or transgender business enterprise, as more particularly set forth in CPUC General Order 156.

“DLF” means a number that is a representation for all net electric energy losses or avoided losses, as filed by SCE at FERC, associated with the transmission of electric energy through the electric system from the high voltage side of the Generating Facility’s substation bus bar to the interface with the CAISO-Controlled Grid, also known as the distribution loss factor.

“Early Termination Date” has the meaning set forth in Section 6.02.

“EFC” means the effective flexible capacity (in MWs) of the Generating Facility pursuant to the Resource Adequacy Rulings and CAISO Tariff, in each case to the extent applicable, and which such flexible capacity may be used to satisfy a load-serving entity’s Flexible RAR.

“Effective Date” has the meaning set forth in the Preamble.

“Emergency” means:

- (a) An actual or imminent condition or situation which jeopardizes the integrity of Transmission Provider’s electric system or the integrity of any other systems to which the Transmission Provider’s electric system is connected, as determined by the Transmission Provider in its reasonable discretion, or any condition so defined and declared by the CAISO; or
- (b) An emergency condition as defined under an interconnection agreement and any abnormal interconnection or system condition that requires automatic or immediate manual action to prevent or limit loss of load or generation supply, that could adversely affect the reliability of the Transmission Provider’s electric system or generation supply, that could adversely affect the reliability of any interconnected system, or that could otherwise pose a threat to public safety.

“Energy Communication Network” means the CAISO infrastructure network (data highway) used by all CAISO participants to exchange data to and from resources and CAISO.

“Energy Deviations” means the absolute value of the difference, in kWh, in any Settlement Interval between:

- (a) Expected Energy; and
- (b) Metered Amounts plus Lost Output.

“Equitable Defense” means any bankruptcy, insolvency, reorganization or other laws affecting creditors’ rights generally, and with regard to equitable remedies, the discretion of the court before which proceedings to obtain equitable remedies may be pending.

“ERR” has the meaning set forth in Section 10.02(b)(i).



“Event of Default” has the meaning set forth in Section 6.01.

“Event of Deficient Energy Deliveries” means any instance in which Seller fails to meet Seller’s Energy Delivery Obligation as determined in accordance with Section 3.07(a)(ii).

“Event of Excess Deliveries” has the meaning set forth in Section 6.01(b)(vi).

“Excess Network Upgrade Costs” has the meaning set forth in Section 2.03(b).

“Expected Annual Net Energy Production” means the Generating Facility’s expected annual Qualified Amounts, as calculated in accordance with Section 1.01(j).

“Expected Energy” has the meaning set forth in the CAISO Tariff.

“Federal Funds Effective Rate” means the annual interest rate posted opposite the caption “Federal Funds (effective)” as set forth in the weekly statistical release as H.15 (519), or any successor publication, published by the Board of Governors of the Federal Reserve System.

“Federal Production Tax Credit Legislation” means validly enacted federal legislation that extends to owners of generating facilities that produce electric energy from wind or other renewable energy resources the applicability of a renewable energy tax credit determined by reference to wind or other renewable energy resources for which Seller, as the owner of the Generating Facility, is eligible.

“FERC” means the Federal Energy Regulatory Commission.

“Financial Consolidation Requirement” has the meaning set forth in Section 8.06(a).

“Fitch” means Fitch Ratings Ltd. or its successor.

“Flexible RAR” means the flexible capacity requirements established for load-serving entities by the CPUC pursuant to the Resource Adequacy Rulings, the CAISO pursuant to the CAISO Tariff, or by any other Governmental Authority having jurisdiction.

“Force Majeure” means any occurrence that was not anticipated as of the Effective Date that:

- (a) In whole or in part:
  - (i) Delays a Party’s performance under this Agreement;
  - (ii) Causes a Party to be unable to perform its obligations; or
  - (iii) Prevents a Party from complying with or satisfying the conditions of this Agreement;
- (b) Is not within the control of that Party; and

- (c) The Party has been unable to overcome by the exercise of due diligence, including an act of God, flood, drought, earthquake, storm, fire, pestilence, lightning and other natural catastrophes, epidemic, war, riot, civil disturbance or disobedience, terrorism, sabotage, strike or labor dispute, or actions or inactions of any Governmental Authority (including a change in Applicable Law but excluding Seller's compliance obligations as set forth in Section 3.19), or curtailment or reduction in deliveries at the direction of a Transmission Provider or the CAISO (except as set forth below).

Force Majeure does not include:

- (d) The lack of wind, sun or other fuel source of an inherently intermittent nature;
- (e) Reductions in generation from the Generating Facility resulting from ordinary wear and tear, deferred maintenance or Operator error;
- (f) Curtailment or reduction in deliveries at the direction of a Transmission Provider or the CAISO when the basis of the curtailment or reduction in deliveries ordered by a Transmission Provider or the CAISO is congestion arising in the ordinary course of operations of the Transmission Provider's system or the CAISO-Controlled Grid, including congestion caused by outages or capacity reductions for maintenance, construction or repair;
- (g) Any delay in providing, or cancellation of, any Permit by the issuing Governmental Authority, except to the extent such delay or cancellation is the result of a force majeure claimed by the Governmental Authority;
- (h) Any delay in providing, or cancellation of, interconnection service by a Transmission Provider, except to the extent such delay or cancellation is the result of a force majeure claimed by the Transmission Provider.

"Forecast" means an hourly forecast provided in accordance with Exhibit D of either:

- (a) The sum of the continuous electrical output ratings for the generator(s) (in MWs) in the Generating Facility that are operational; or
- (b) The sum of electric energy (in MWh) expected to be generated by the Generating Facility

in accordance with SCE instructions.

"Forecasted Commercial Operation Date" means the date Seller anticipates, as of the Effective Date, will be the Commercial Operation Date, as set forth in Section 1.02.

"Forecasting" means the action of Seller in preparing and submitting the Forecasts to SCE.

"Forward Settlement Amount" means the Non-Defaulting Party's Costs and Losses, on the one hand, netted against its Gains, on the other.

If the Non-Defaulting Party's Costs and Losses exceed its Gains, then the Forward Settlement Amount shall be an amount owing to the Non-Defaulting Party.

If the Non-Defaulting Party's Gains exceed its Costs and Losses, then the Forward Settlement Amount shall be Zero dollars (\$0).

The Forward Settlement Amount does not include consequential, incidental, punitive, exemplary or indirect or business interruption damages.

"Full Capacity Deliverability Status" or "FCDS" has the meaning set forth in the CAISO Tariff.

"GAAP" means accounting principles generally accepted in the United States of America.

"Gains" means, with respect to any Party, an amount equal to the present value of the economic benefit to it, if any (exclusive of Costs), resulting from the termination of this Agreement for the remaining Term of this Agreement, determined in a commercially reasonable manner.

Factors used in determining the economic benefit to a Party may include, without limitation, reference to information supplied by one or more third parties, which shall exclude Affiliates of the Non-Defaulting Party, including without limitation, quotations (either firm or indicative) of relevant rates, prices, yields, yield curves, volatilities, spreads or other relevant market data in the relevant markets, comparable transactions, forward price curves based on economic analysis of the relevant markets, settlement prices for comparable transactions at liquid trading hubs (e.g., NYMEX), all of which should be calculated for the remaining Term of this Agreement, and includes the value of Green Attributes, Capacity Attributes and Resource Adequacy Benefits.

Only if the Non-Defaulting Party is unable, after using commercially reasonable efforts, to obtain third-party information to determine the gain of economic benefits, *then* the Non-Defaulting Party may use information available to it internally suitable for this purpose in accordance with prudent industry practices.

"Generating Facility" means Seller's electric generating facility as more particularly described in Exhibit B, together with all materials, equipment systems, structures, features and improvements necessary to produce electric energy at the facility, excluding the Site, land rights and interests in land.

"Generation Management System" or "GMS" means the automated system, or its successor system, employed by SCE real time operations to remotely monitor and dispatch the Generating Facility.

"Generation Operations Center" or "GOC" means the location of SCE's real time operations personnel.

"Generator Operator" means the entity that Operates the Generating Facility and performs the functions of supplying energy and interconnected operations services as described in the NERC Reliability Standards.

“Generator Operator Obligations” means the obligations of a Generator Operator as set forth in all applicable NERC Reliability Standards.

“Generator Owner” means an entity that owns the Generating Facility and has registered with NERC as the entity responsible for complying with those NERC Reliability Standards applicable to owners of generating units as set forth in the NERC Reliability Standards.

“Generator Owner Obligations” means the obligations of a Generator Owner as set forth in all applicable NERC Reliability Standards.

“Governmental Authority” means:

- (a) Any federal, state, local, municipal or other government;
- (b) Any governmental, regulatory or administrative agency, commission, or other authority lawfully exercising or entitled to exercise any administrative, executive, judicial, legislative, police, regulatory or taxing authority or power; or
- (c) Any court or governmental tribunal.

“Governmental Charges” has the meaning as set forth in Section 9.02.

“Green Attributes” means any and all credits, benefits, emissions reductions, offsets, and allowances, howsoever entitled, attributable to the generation from the Project, and its avoided emission of pollutants. Green Attributes include but are not limited to Renewable Energy Credits, as well as:

- (1) Any avoided emission of pollutants to the air, soil or water such as sulfur oxides (SO<sub>x</sub>), nitrogen oxides (NO<sub>x</sub>), carbon monoxide (CO) and other pollutants;
- (2) Any avoided emissions of carbon dioxide (CO<sub>2</sub>), methane (CH<sub>4</sub>), nitrous oxide, hydrofluorocarbons, perfluorocarbons, sulfur hexafluoride and other greenhouse gases (GHGs) that have been determined by the United Nations Intergovernmental Panel on Climate Change, or otherwise by law, to contribute to the actual or potential threat of altering the Earth’s climate by trapping heat in the atmosphere;<sup>1</sup>
- (3) The reporting rights to these avoided emissions, such as Green Tag Reporting Rights.

Green Tag Reporting Rights are the right of a Green Tag Purchaser to report the ownership of accumulated Green Tags in compliance with federal or state law, if applicable, and to a federal or

---

<sup>1</sup> Avoided emissions may or may not have any value for GHG compliance purposes. Although avoided emissions are included in the list of Green Attributes, this inclusion does not create any right to use those avoided emissions to comply with any GHG regulatory program.

state agency or any other party at the Green Tag Purchaser's discretion, and include without limitation those Green Tag Reporting Rights accruing under Section 1605(b) of The Energy Policy Act of 1992 and any present or future federal, state, or local law, regulation or bill, and international or foreign emissions trading program. Green Tags are accumulated on a MWh basis and one Green Tag represents the Green Attributes associated with one (1) MWh of energy.

Green Attributes do not include:

- (i) Any energy, capacity, reliability or other power attributes from the Project,
- (ii) Production tax credits associated with the construction or operation of the Project and other financial incentives in the form of credits, reductions, or allowances associated with the Project that are applicable to a state or federal income taxation obligation,
- (iii) Fuel-related subsidies or "tipping fees" that may be paid to Seller to accept certain fuels, or local subsidies received by the generator for the destruction of particular preexisting pollutants or the promotion of local environmental benefits, or
- (iv) Emission reduction credits encumbered or used by the Project for compliance with local, state, or federal operating and/or air quality permits.

If the Project is a biomass or biogas facility and Seller receives any tradable Green Attributes based on the greenhouse gas reduction benefits or other emission offsets attributed to its fuel usage, it shall provide SCE with sufficient Green Attributes to ensure that there are zero (0) net emissions associated with the production of electricity from the Project.

"Green Market Price" means the market price for energy and Green Attributes from an ERR.

"IFRS" means the International Financial Reporting Standards.

"Indemnified Party" has the meaning set forth in Section 10.03(d).

"Indemnitor" has the meaning set forth in Section 10.03(d).

"Interconnection Point" means the location where the Generating Facility first interconnects with the existing electrical transmission or distribution system, as reported on the Generating Facility's interconnection agreement with the Transmission Provider, as described in Section 1.01(e).

"Interconnection Queue Position" is the order of Seller's valid request for interconnection relative to all other valid interconnection requests, as specified in Section 1.07.

"Interconnection Study" means any of the studies defined in the CAISO's Tariff or any Transmission Provider's tariff that reflect methodology and costs to interconnect the Generating Facility to the Transmission Provider's electric grid.

"Interest Rate" means, for any date:

- (a) The per annum rate of interest equal to the “Prime Rate” published in *The Wall Street Journal* under “Money Rates” or such date (or if not published on such date on the most recent preceding day on which published); plus
- (b) Two percentage points (2%);

*provided*, in no event may the Interest Rate exceed the maximum interest rate permitted by Applicable Laws.

“Internal Revenue Code” means Title 26 of the United States Code.

“JAMS” has the meaning set forth in Article Twelve.

“kW” means a kilowatt of alternating current electric energy generating capacity.

“kWh” means a kilowatt-hour of alternating current electric energy.

“Lease” means one or more agreements whereby Seller leases the real property of the Site described in Section 1.01(b) from a third party, the term of which lease begins on or before the commencement of construction of the Generating Facility and extends at least through the last day of the Term.

“Lender” means any financial institutions or successors in interest or assignees that provide(s) development, bridge, construction, permanent debt or tax equity financing or refinancing for the Generating Facility to Seller.

“Letter of Credit” means an irrevocable, nontransferable standby letter of credit, substantially in the form of Exhibit L and acceptable to SCE, provided by Seller from an issuer acceptable to SCE that is either a U.S. financial institution or commercial bank or a U.S. branch of a foreign bank with the financial institution or bank having a Credit Rating of at least (a) “A-” from S&P and Fitch, and “A3” from Moody’s, if such entity is rated by all three ratings agencies; or (b) “A-” from S&P or Fitch, or “A3” from Moody’s, if such entity is rated by only one or two of the ratings agencies. Seller must bear the costs of all Letters of Credit.

“Letter of Credit Default” means with respect to a Letter of Credit, the occurrence of any of the following events:

- (a) The issuer of the Letter of Credit fails to comply with or perform its obligations under such Letter of Credit;
- (b) The issuer of the Letter of Credit disaffirms, disclaims, repudiates or rejects, in whole or in part, or challenges the validity of, the Letter of Credit;
- (c) The Letter of Credit fails or ceases to be in full force and effect at any time;
- (d) Seller fails to provide an extended or replacement Letter of Credit prior to twenty (20) Business Days before the Letter of Credit expires or terminates;
- (e) The issuer of the Letter of Credit becomes Bankrupt; or

*The contents of this document are subject to restrictions on disclosure as set forth herein.*

- (f) The issuer of a Letter of Credit fails to maintain a Credit Rating of at least (i) “A-” from S&P and Fitch, and “A3” from Moody’s, if such entity is rated by all three ratings agencies; or (ii) “A-” from S&P or Fitch, or “A3” from Moody’s, if such entity is rated by only one or two of the such ratings agencies;

*provided*, no Letter of Credit Default will occur or be continuing in any event with respect to a Letter of Credit after the time such Letter of Credit is required to be canceled or returned to a Party in accordance with the terms of this Agreement.

“Local Capacity Area” has the meaning set forth in the CAISO Tariff.

“Local RAR” means the local Resource Adequacy Requirements established for load-serving entities by the CPUC pursuant to the Resource Adequacy Rulings, the CAISO pursuant to the CAISO Tariff, or by any other Governmental Authority having jurisdiction. “Local RAR” may also be known as local area reliability, local resource adequacy, local resource adequacy procurement requirements, or local capacity requirement in other regulatory proceedings or legislative actions.

“Locational Marginal Price” or “LMP” has the meaning set forth in the CAISO Tariff.

“Losses” means, with respect to any Party, an amount equal to the present value of the economic loss to it, if any (exclusive of Costs), resulting from termination of this Agreement for the remaining Term of this Agreement, determined in a commercially reasonable manner.

Factors used in determining economic loss to a Party may include, without limitation, reference to information supplied by one or more third parties, which shall exclude Affiliates of the Non-Defaulting Party, including without limitation, quotations (either firm or indicative) of relevant rates, prices, yields, yield curves, volatilities, spreads or other relevant market data in the relevant markets, comparable transactions, forward price curves based on economic analysis of the relevant markets, settlement prices for comparable transactions at liquid trading hubs (e.g., NYMEX), all of which should be calculated for the remaining Term of this Agreement and must include the value of Green Attributes, Capacity Attributes and Resource Adequacy Benefits.

Only if the Non-Defaulting Party is unable, after using commercially reasonable efforts, to obtain third-party information to determine the loss of economic benefits, then the Non-Defaulting Party may use information available to it internally suitable for these purposes in accordance with prudent industry practices.

“Lost Output” means the reduction in Qualified Amounts over the relevant measurement period that the Generating Facility was available to produce and could reasonably have been expected to deliver, based upon the calculation method set forth in Exhibit K, but was not delivered due to a Lost Output Event.

“Lost Output Event” means any of the following occurrences which cause Seller to be unable to deliver energy:

- (a) Force Majeure;

*The contents of this document are subject to restrictions on disclosure as set forth herein.*

- (b) An Event of Default where SCE is the Defaulting Party;
- (c) A curtailment or reduction of deliveries in accordance with Section 3.12(g) or as otherwise ordered or caused by the CAISO, or SCE acting as a Transmission Provider (including without limitation a curtailment or reduction that does not constitute a Force Majeure as provided in subparagraph (f) or (h) of the definition of Force Majeure); or
- (d) An Emergency, to the extent not already covered in item (c) above.

“Lost Output Report” means the monthly report of Lost Output in the form of the worksheet from the Lost Output Workbook prepared in accordance with the procedures set forth in Section 3.21 and Exhibit K.

“Lost Output Workbook” has the meaning set forth in Exhibit K.

“Material Permits” means all permits required for Commercial Operation of the Generating Facility, as set forth on Exhibit G.

“Mediator” has the meaning set forth in Article Twelve.

“Metered Amounts” means the electric energy produced by the Generating Facility, expressed in kWh, as recorded by the CAISO Approved Meter(s), or Check Meter(s), as applicable.

“Milestone Schedule” means Seller’s schedule to develop the Generating Facility as set forth in Exhibit G, including any revisions thereto in accordance with this Agreement.

“Monthly Profile” has the meaning set forth in Exhibit K.

“Moody’s” means Moody’s Investor Services, Inc.

“Multiplier” has the meaning set forth in Section 3.02.

“MW” means a megawatt (or 1,000 kilowatts) of alternating current electric energy generating capacity.

“MWh” means a megawatt-hour (or 1,000 kilowatt-hours) of alternating current electric energy.

“Negative LMP” means, in any Settlement Interval, the LMP at the Generating Facility’s PNode is less than Zero dollars (\$0).

“Negative LMP Costs” has the meaning set forth in Section 1.05(c)(i).

“NERC” means the North American Electric Reliability Corporation, or any successor thereto.



“NERC Reliability Standards” means those reliability standards applicable to the Generating Facility, or to the Generator Owner or the Generator Operator with respect to the Generating Facility, that are adopted by NERC and approved by the applicable regulatory authorities.

“NERC Standards Non-Compliance Penalties” means any and all monetary fines, penalties, damages, interest or assessments by the NERC, CAISO, WECC, a Governmental Authority or any entity acting at the direction of a Governmental Authority arising from or relating to a failure to perform the obligations of Generator Operator or Generator Owner as set forth in the NERC Reliability Standards.

“Net Qualifying Capacity” has the meaning set forth in the CAISO Tariff.

“Network Upgrades Cap” has the meaning set forth in Section 2.03(b)(i)(1).

“Non-Availability Charges” has the meaning set forth in the CAISO Tariff.

“Non-Defaulting Party” has the meaning set forth in Section 6.02.

“Non-Disclosure Agreement” shall mean that certain Non-Disclosure Agreement between the Parties dated as of July 27, 2016.

“Notice” means notices, requests, statements or payments provided in accordance with Section 10.08 and Exhibit C.

“Notice of Non-Renewal” has the meaning set forth in Section 8.02(b)(iv)(2).

“OMAR” means the Operational Metering Analysis and Reporting System operated and maintained by the CAISO as the repository of settlement quality meter data or its successor.

“Operate”, “Operated”, “Operating” or “Operation” means to provide (or the provision of) all the operation, engineering, purchasing, repair, supervision, training, inspection, testing, protection, use, management, improvement, replacement, refurbishment, retirement, and maintenance activities associated with operating the Generating Facility in accordance with Prudent Electrical Practices.

“Operating Procedures” has the meaning as set forth in the CAISO Tariff.

“Outage Schedule” has the meaning set forth in Section 3.15.

“Paid Curtailed Product” means the CP for which SCE is obligated to pay Seller pursuant to Section 4.01(c).

“Party” or “Parties” have the meaning set forth in the Preamble.

“Payment Invoices” are invoices issued by SCE to Seller detailing amounts owed by SCE to Seller or by Seller to SCE for energy deliveries, CAISO Revenues, CAISO Costs, CAISO

Sanctions, SCE Penalties and other charges and adjustments as may be owed by the Parties, in accordance with Exhibit E.

“Performance Assurance” means collateral (in the amount of the Performance Assurance Amount set forth in Section 1.06) for Seller’s performance under this Agreement in the form of cash or Letter(s) of Credit.

“Performance Assurance Amount” means the collateral amount for Performance Assurance set forth in Section 1.06.

“Performance Tolerance Band” has the meaning set forth in Exhibit M.

“Permit Approval” means approval by the relevant regulatory agencies of any Permit and shall be deemed obtained upon the issuance of such Permit, and shall not be invalidated by the pendency of an appeal or other post-issuance challenge to the issuance of the Permit.

“Permits” means all applications, approvals, authorizations, consents, filings, licenses, orders, permits or similar requirements imposed by any Governmental Authority, or the CAISO, in order to develop, construct, Operate, maintain, improve, refurbish and retire the Generating Facility or to Forecast or deliver the electric energy produced by the Generating Facility to SCE.

“PNode” has the meaning set forth in the CAISO Tariff.

“Product” has the meaning set forth in Section 1.01(d).

“Product Payment” has the meaning set forth in Exhibit E.

“Product Payment Allocation Factor” means the product payment allocation factors set forth in Exhibit I.

“Product Price” has the meaning set forth in Section 1.05.

“Product Replacement Damage Amount” has the meaning set forth in Section 3.07(b).

“Project” means the Generating Facility.

“Proposal” means the proposal Seller submitted to SCE in response to SCE’s 2015 request for proposals to supply energy and associated Green Attributes, Capacity Attributes and Resource Adequacy Benefits from eligible renewable resources.

“Prudent Electrical Practices” means those practices, methods and acts that would be implemented and followed by prudent operators of electric energy generating facilities in the Western United States, similar to the Generating Facility, during the relevant time period, which practices, methods and acts, in the exercise of prudent and responsible professional judgment in the light of the facts known or that should reasonably have been known at the time the decision

was made, could reasonably have been expected to accomplish the desired result consistent with good business practices, reliability and safety.

Prudent Electrical Practices shall include, at a minimum, those professionally responsible practices, methods and acts described in the preceding sentence that comply with manufacturers' warranties, restrictions in this Agreement, and the requirements of Governmental Authorities, WECC standards, the CAISO and Applicable Laws.

Prudent Electrical Practices also includes taking reasonable steps to ensure that:

- (a) Equipment, materials, resources, and supplies, including spare parts inventories, are available to meet the Generating Facility's needs;
- (b) Sufficient Operating personnel are available at all times and are adequately experienced and trained and licensed as necessary to Operate the Generating Facility properly and efficiently, and are capable of responding to reasonably foreseeable emergency conditions at the Generating Facility and Emergencies whether caused by events on or off the Site;
- (c) Preventive, routine, and non-routine maintenance and repairs are performed on a basis that ensures reliable, long term and safe Operation of the Generating Facility, and are performed by knowledgeable, trained, and experienced personnel utilizing proper equipment and tools;
- (d) Appropriate monitoring and testing are performed to ensure equipment is functioning as designed;
- (e) Equipment is not Operated in a reckless manner, in violation of manufacturer's guidelines or in a manner unsafe to workers, the general public, or the Transmission Provider's electric system or contrary to environmental laws, permits or regulations or without regard to defined limitations such as, flood conditions, safety inspection requirements, operating voltage, current, volt ampere reactive (VAR) loading, frequency, rotational speed, polarity, synchronization, and control system limits; and
- (f) Equipment and components are designed and manufactured to meet or exceed the standard of durability that is generally used for electric energy generating facilities operating in the Western United States and will function properly over the full range of ambient temperature and weather conditions reasonably expected to occur at the Site and under both normal and emergency conditions.

"Qualified Amounts" means the Metered Amounts, expressed in kWh, that qualify as renewable power under the requirements of the California Renewables Portfolio Standard, or which do not so qualify solely due to a change in RPS Legislation occurring after the Effective Date, subject to Seller's compliance with Section 1.08.

"Qualifying Capacity" means the maximum amount of Resource Adequacy Benefits a generating facility could provide before an assessment of its Net Qualifying Capacity, as determined

pursuant to the relevant methodology established by the CPUC. For purposes of determining “Qualifying Capacity”, it shall be assumed that the Generating Facility is fully deliverable.

“Qualified Reporting Entity” has the meaning set forth in the WREGIS Operating Rules, as applicable to the Generating Facility as the Registered Generating Unit.

“RA Deficit Payments” has the meaning set forth in Section 3.02.

“RAP ID” means the contract identification number set forth on the title page to this Agreement.

“Real-Time Availability” means Seller’s cumulative available capacity of the Generating Facility on a real-time basis.

“Real-Time Market” has the meaning set forth in the CAISO Tariff.

“Registered Generating Unit” has the meaning set forth in WREGIS Operating Rules, as applicable to the Generating Facility.

“Renewable Energy Credit” or “REC” has the meaning set forth in CPUC Decision D.08-08-028, as such definition may be modified by the CPUC or Applicable Law from time to time.

“Required Material” means any permit, license, application, certification, design, specification, program, agreement, instrument, equipment, device, mechanism, or any other item in connection with the Generating Facility to be reviewed or approved by SCE or on SCE’s behalf, or requested or required of Seller by SCE or on SCE’s behalf, under this Agreement.

“Resource Adequacy Benefits” means the rights and privileges attached to the Generating Facility that satisfy any entity’s Resource Adequacy Requirements, as those obligations are set forth in any Resource Adequacy Rulings and shall include any local, zonal or otherwise locational attributes associated with the Generating Facility.

“Resource Adequacy Requirements” or “RAR” means the resource adequacy requirements applicable to a person or entity pursuant to the Resource Adequacy Rulings, the CAISO pursuant to the CAISO Tariff, or by any other Governmental Authority having jurisdiction.

“Resource Adequacy Rulings” means CPUC Decisions 04-01-050, 04-10-035, 05-10-042, 06-04-040, 06-06-064, 06-07-031 06-07-031, 07-06-029, 08-06-031, 09-06-028, 10-06-036, 11-06-022, 12-06-025, 13-06-024 and any other existing or subsequent ruling or decision, or any other resource adequacy laws, rules or regulations enacted, adopted or promulgated by any applicable Governmental Authority, as such decisions, rulings, laws, rules or regulations may be amended or modified from time-to-time throughout the Delivery Term.

“Responsible Officer” means the chief financial officer, treasurer or any assistant treasurer of a Party or any employee of a Party designated by any of the foregoing.

“Restricted Period” has the meaning set forth in Section 2.04(b).

“RPS” means the State of California Renewable Portfolio Standard Program.

“RPS Legislation” means the State of California Renewable Portfolio Standard Program, as codified at California Public Utilities Code Section 399.11, *et seq.*

“S&P” means the Standard & Poor’s Financial Services LLC.

“SC Set-up Fee” has the meaning set forth in Section 3.13(a)(iii).

“SCE” has the meaning set forth in the Preamble.

“Schedule,” “Scheduled” or “Scheduling” means the action of SCE in submitting Bids to the CAISO and receiving all CAISO Markets results from the CAISO.

“Scheduling Coordinator” or “SC” means an entity certified by the CAISO for the purposes of undertaking the functions specified by the CAISO Tariff.

“SEC” means the Securities and Exchange Commission.

“Security Interest” has the meaning set forth in Section 8.03.

“Seller” has the meaning set forth in the Preamble.

“Seller’s Debt” means, without duplication, each of the following:

- (a) All indebtedness of Seller for borrowed money;
- (b) All obligations of Seller for the deferred purchase price of property or services which purchase price is due more than six months after the date of placing such property in service or taking delivery or title thereto or the completion of such services (other than trade payables not overdue by more than ninety (90) days incurred in the ordinary course of Seller’s business);
- (c) All obligations of Seller evidenced by notes, bonds, debentures, Disqualified Stock or other similar instruments;
- (d) All obligations of Seller created or arising under any conditional sale or other title retention agreement with respect to property acquired by Seller (even though the rights and remedies of the seller or lender under such agreement in the event of default are limited to repossession or sale of such property);
- (e) All monetary obligations of Seller under:
  - (i) A lease of any property (whether real, personal or mixed) by Seller as lessee that, in conformity with GAAP, is accounted for as a capital lease on the balance sheet of Seller;

*The contents of this document are subject to restrictions on disclosure as set forth herein.*

- (ii) A so-called synthetic, off-balance sheet or tax retention lease; or
- (iii) An agreement for the use or possession of property creating obligations which do not appear on the balance sheet of Seller but which, upon the insolvency or bankruptcy of Seller, would be characterized as indebtedness of Seller (without regard to accounting treatment);
- (f) All obligations, contingent or otherwise, of Seller under acceptance, letter of guaranty, letter of credit or similar facilities;
- (g) All obligations of Seller with respect to any redeemable equity interests in Seller, including in the case of preferred stock at the greater of the voluntary or involuntary liquidation preference plus accrued and unpaid dividends;
- (h) All obligations of Seller with respect to any swaps, caps or collar agreements or similar arrangements to hedge against fluctuations in interest rates or currency exchange rates or the exchange of nominal interest obligations, either generally or under specific contingencies, in each case, valued at the aggregate net mark-to-market value;
- (i) All indebtedness of others referred to in clauses (a) through (h) above guaranteed by Seller, or in effect guaranteed by Seller through an agreement:
  - (i) To pay or purchase such indebtedness or to advance or supply funds for the payment or purchase of such indebtedness;
  - (ii) To purchase, sell or lease (as lessee or lessor) property, or to purchase or sell services, primarily for the purpose of enabling the debtor to make payment of the indebtedness or to assure the holder of such indebtedness against loss;
  - (iii) To supply funds to or invest in the debtor (including any agreement to pay for property or services irrespective of whether such property is received or such services are rendered); or
  - (iv) Otherwise to assure a creditor against loss; and
- (j) Without duplication of the foregoing, all indebtedness referred to in clauses (a) through (i) above secured by any lien on property (including accounts and contract rights) owned by Seller.

The outstanding amount of indebtedness as described above at any date will be the outstanding balance at such date of all unconditional obligations as described above and, with respect to contingent obligations as described above, the maximum liability upon the occurrence of the contingency giving rise to the obligation.

Notwithstanding the foregoing, the term “Seller’s Debt” as used herein does not include Seller’s obligations under this Agreement and the Lease (provided that such Lease does not constitute an obligation of Seller described in clause (e) of the first sentence of this definition).

“Seller’s Energy Delivery Obligation” has the meaning set forth in Section 3.07(a)(i).

“Settlement Interval” has the meaning set forth in the CAISO Tariff.

“Simple Interest Payment” means a dollar amount calculated by multiplying the:

- (a) Dollar amount on which the Simple Interest Payment is based; times
- (b) Federal Funds Effective Rate or Interest Rate, as applicable; times
- (c) The result of dividing the number of days in the calculation period by 360.

“Site Control” means that Seller shall:

- (a) Own the Site;
- (b) Be the lessee of the Site under a Lease;
- (c) Be the holder of a right-of-way grant or similar instrument with respect to the Site; or

Be the managing partner or other person or entity authorized to act in all matters relating to the control and Operation of the Site and the Generating Facility.

“Station Use” means:

- (a) The electric energy produced by the Generating Facility that is used within the Generating Facility to power the lights, motors, control systems and other electrical loads that are necessary for Operation; and
- (b) The electric energy produced by the Generating Facility that is consumed within the Generating Facility’s electric energy distribution system as losses.

“Successor” has the meaning set forth in Section 8.06(b)(iii).

“Supervisory Control and Data Acquisition” or “SCADA” has the meaning set forth in the CAISO Tariff.

“Supplemental Lost Output” has the meaning set forth in Section 3.21.

“Supplemental Lost Output Report” has the meaning set forth in Section 3.21.

“Telemetry System” means a system of electronic components that interconnects the Generating Facility, GMS and the CAISO as set forth in Section 3.08(e).

“Term” means the term of this Agreement as set forth in Section 1.04.

“Term Year” means a twelve (12) month period beginning on the first day of the calendar month following the Commercial Operation Date and each successive twelve (12) month period thereafter.

“Termination Payment” means the sum of all amounts owed by the Defaulting Party to the Non-Defaulting Party under this Agreement, less any amounts owed by the Non-Defaulting Party to the Defaulting Party determined as of the Early Termination Date.

“TOD Period(s)” means the time of delivery period(s) set forth in Exhibit I.

“TOD Period Product Payment” means a portion of a Product Payment based upon the time of delivery of Product and calculated in accordance with the formula set forth in Section 2.02 of Exhibit E.

“Trading Day” has the meaning set forth in the CAISO Tariff.

“Transmission Provider” means any entity or entities responsible for the interconnection of the Generating Facility with a Control Area or transmitting the Metered Amounts on behalf of Seller from the Generating Facility to the Delivery Point.

“Unincluded Capacity” has the meaning set forth in Section 3.06(g)(iii).

“Web Client” means a web-based system approved by SCE.

“WECC” means the Western Electricity Coordinating Council, the regional reliability council for the Western United States, Northwestern Mexico and Southwestern Canada.

“WMDVBE” means women, minority, and disabled veteran business enterprise, as more particularly set forth in CPUC General Order 156.

“WREGIS” has the meaning set forth in Section 3.01(d)(iv).

“WREGIS Certificate(s)” has the same meaning as “Certificate” as defined by WREGIS in the WREGIS Operating Rules.

“WREGIS Operating Rules” means the rules published by the Western Electricity Coordination Council for the rules and operations of WREGIS.

---

\*\*\* End of EXHIBIT A \*\*\*



## **EXHIBIT B**

### *Generating Facility and Site Description*

Name and Address of Generating Facility:

Pacific Ultrapower Chinese Station  
8755 Enterprise Drive, Jamestown, CA 95327

Latitude and Longitude: 37.874369, -120.477336

Technology: EPI/Zurn bubbling bed boiler

Ultimate Heat Sink: GEA air-cooled condenser

Fuel Type and Source: High Hazard Zone Fuel will be sourced from the Project’s historical fuel supply area to minimize transportation costs. The weighted average one-way haul distances for each year are 39 miles in 2017, 40 miles in 2018, 44 miles in 2019 and beyond. All High Hazard Zone Fuel in HHZ Fuel Zone #1 will be byproducts from local sawmills processing trees from the high hazard zone, which are planned to increase each year. 11-13% of the total High Hazard Zone Fuel will be generated from satellite wood yards which will collect high hazard zone material generated from the WUI and high hazard zone areas where road systems only allow for log-truck access. The balance of the High Hazard Zone Fuel will be from in-forest chipping operations focused on removing tree mortality and fuel reduction efforts on federal, private industrial foest lands, and private non-industrial forest lands.

Item	Manufacturer	Model Number	Nameplate Rating	Quantity	Total Rating
<b>Steam Generator</b>	EPI/Zurn	#2	_208,000_ lb/hr	1	_208,000__ lb/hr
<b>Prime Mover</b>	GE turbine	S/N 37368	_25,600_ kW	1	25,600__ kW
<b>Generator</b>	Electric Machine generator	S/N #184345501	_25,6000 kVA @ ___1.0_ p.f.	1	_25,600__ kVA @ ___1.0__ p.f.
<b>Primary Step Up Transformer</b>	<i>[optional]</i>	<i>[optional]</i>	<i>[30,667 KVA, 115,000V, 12,470 V]</i>	1	30,667KVA

Description of Host Facility:

*N/A Biomass Generator has no host facility*

*The contents of this document are subject to restrictions on disclosure as set forth herein.*

RAP ID #1242, Pacific Ultrapower Chinese Station

Thermal Energy to Host Facility, MMBtu/year: *N/A*

Percent of Total Annual Thermal Output: *N/A*

Electric Energy to Host Facility, MWh/year: *NA*

Percent of Total Annual Electric Output: *N/A*

Description of Shared Facilities: *None*

confidential  
Toshio Matsunaga  
IHI  
Sep 06, 2012 11:44

Title Policy - Chinese Station 1984  
3.3.2.1

# Schedule C

The land referred to herein is described as follows:

## DESCRIPTION

All that certain real property in the County of Tuolumne, State of California, described as follows:

Parcel 1, Map for HATLER LUMBER COMPANY, recorded October 31, 1984 in Book 21 of Parcel Maps, at Page 14, Tuolumne County Records.

confidential  
Toshio Matsunaga  
IHI  
Sep 06, 2012 11:44

Title Policy - Chinese Station 1984  
3.3.2.1

Search

**Property Detail**

Transaction History

Supplemental Tax Estimator

Recent Sales

Property Reports

Kaenan Whitman , County Assessor

APN

064-180-54-00

Situs Address

8755 ENTERPRISE DR CA 92656

APN Map

Open

Value Change Notice

**General Information**

**APN:** 064-180-54-00 **Use Type:** INDUSTRIAL  
**Situs Address:** 8755 ENTERPRISE DR CA 92656 **Tax Rate Area:** 063-036  
**Mailing Address:** 95 ENTERPRISE ALISO VIEJO CA 92656  
**Legal Description:** PAR 1 PM 21-13 POR SEC 5 6 T1S R14E 26.3

**Assessment**

**Year Assd:** 2016  
**Land:** \$856,574  
**Structure(s):** \$2,089,722  
**Other:** \$430,983  
**Total Land and Improv:** \$3,377,279  
**HO Exempt?:** ---  
**Exemption Amt:** ---

**Property Characteristics**

**Bedrooms:**  
**Baths:** 8,420  
**Bldg/Liv Area:** 26,380  
**Year Built:** 1,149,112  
**Lot Acres:**  
**Lot SqFt:**

**Recent Sale History**

**Document Image:** No Document Found  
**Recording Date:** N/A  
**Document #:**  
**Transfer Amount:**

**CLICK HERE**  
 For More Info  
 on this Property!



Map data ©2016 Google Imagery ©2016 DigitalGlobe, USDA Farm Service Agency

\*\*The information provided here is deemed reliable, but is not guaranteed.

POR. T.1 S., R.14 E., M.D.B.&M.

Tax Rate Area  
63-036

64-18

1"=1200'

19

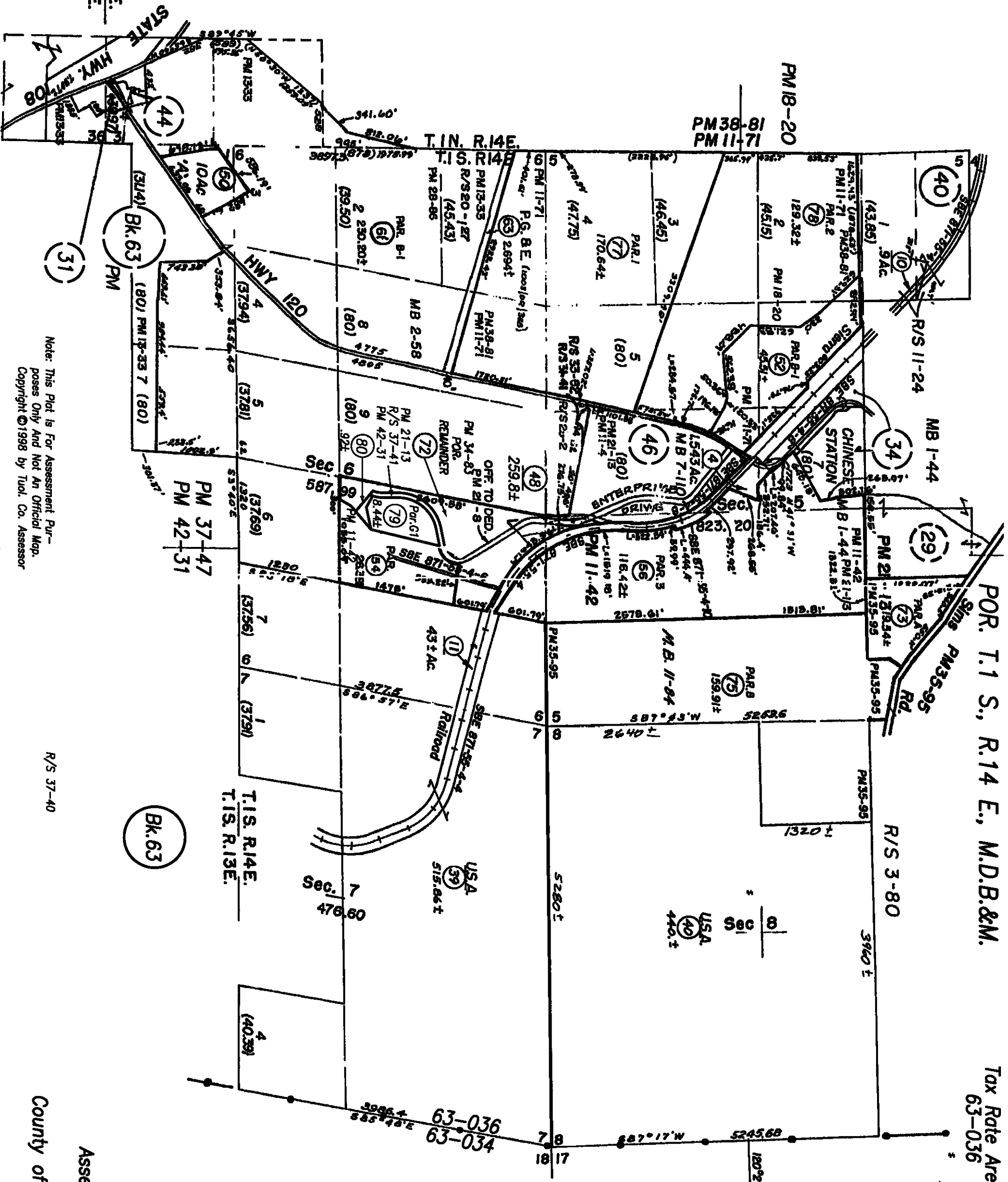

T.1 N. R.14 E.  
T.1 N. R.13 E.

Bk. 63

Bk. 63

Bk. 63

Note: This Plot is For Assessment Pur-  
poses Only And Not An Official Map.  
Copyright ©1998 by Tuol. Co. Assessor

R/S 37-40

Assessor's Map  
64-18  
County of Tuolumne, Calif.  
1949

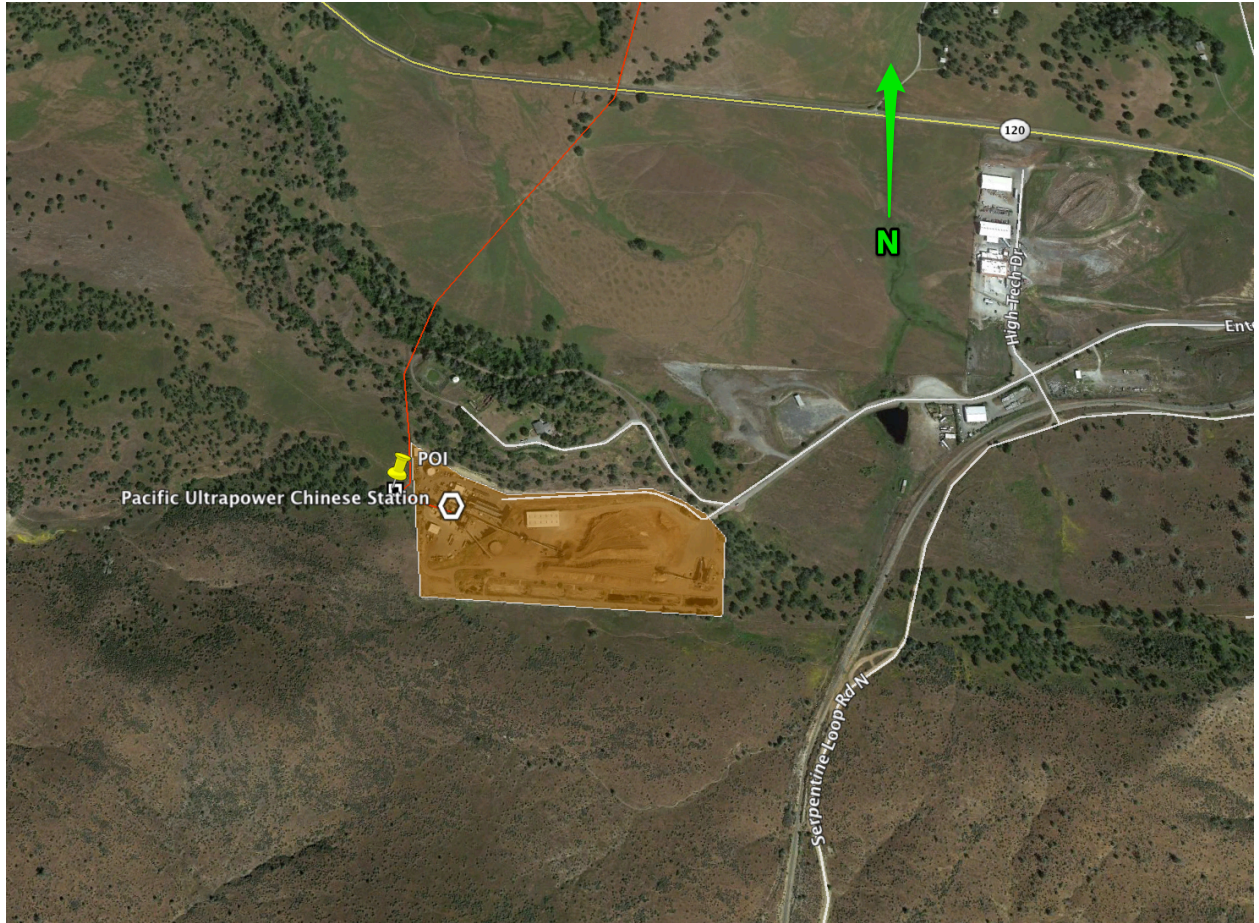

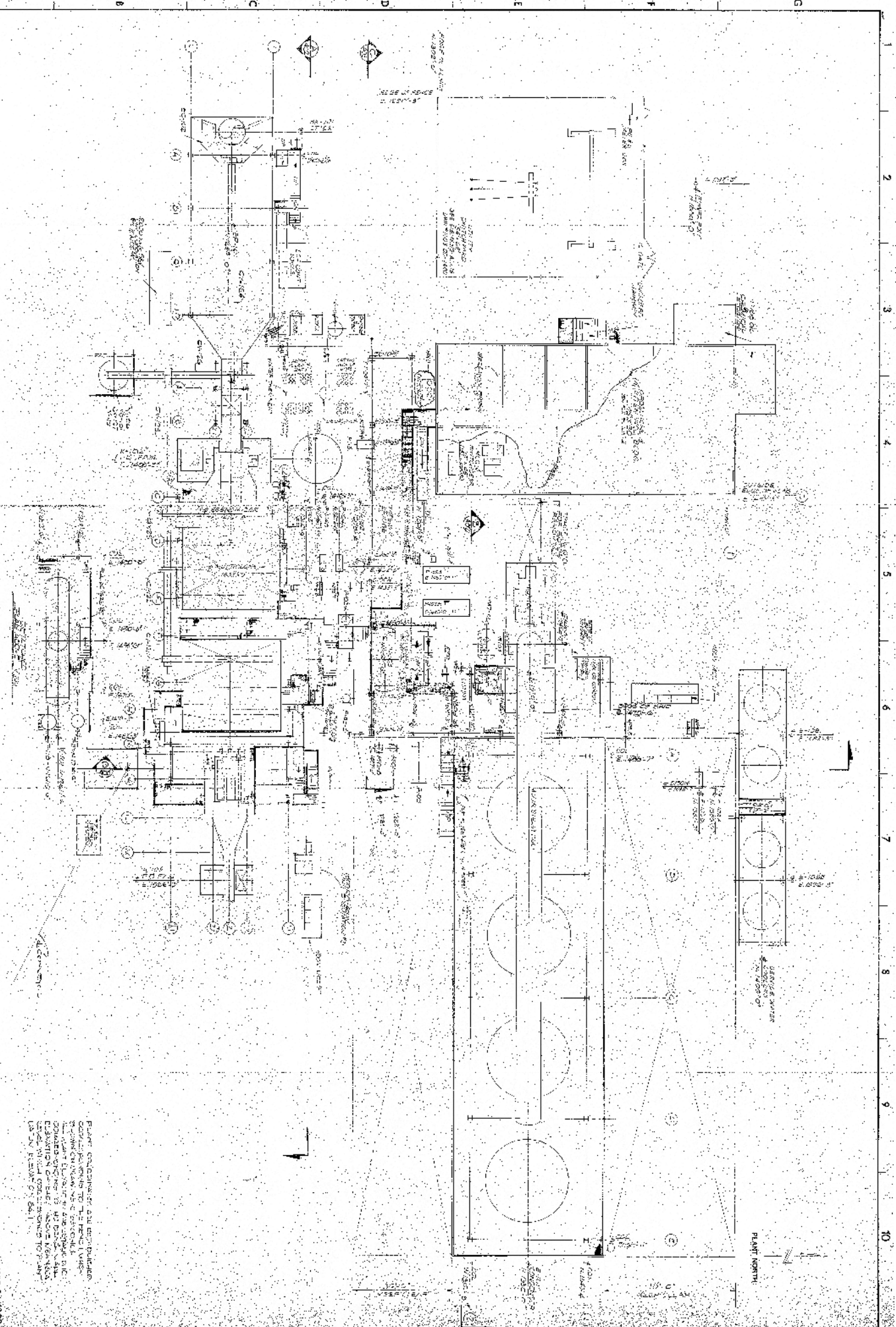

PLANT NORTH

SECTION A-A

**GENERAL ARRANGEMENT PLAN**

MARK 11-1985

NO. 10	DATE	REVISION	BY	CHKD.
1	11/15/85	ISSUED FOR CONSTRUCTION	J. R. POWERS	
2	12/10/85	REVISED TO SHOW CHANGES	J. R. POWERS	
3	01/15/86	REVISED TO SHOW CHANGES	J. R. POWERS	
4	02/15/86	REVISED TO SHOW CHANGES	J. R. POWERS	
5	03/15/86	REVISED TO SHOW CHANGES	J. R. POWERS	
6	04/15/86	REVISED TO SHOW CHANGES	J. R. POWERS	
7	05/15/86	REVISED TO SHOW CHANGES	J. R. POWERS	
8	06/15/86	REVISED TO SHOW CHANGES	J. R. POWERS	
9	07/15/86	REVISED TO SHOW CHANGES	J. R. POWERS	
10	08/15/86	REVISED TO SHOW CHANGES	J. R. POWERS	

ULTRASYSTEMS

CONDENSER AND COOLING TOWER

10000 S. 100th ST.

APRIL, WASHINGTON, D.C.

TEL: (301) 477-1000

FAX: (301) 477-1001

TELETYPE: (301) 477-1002

INTERNET: WWW.ULTRASYSTEMS.COM

WWW.ULTRASYSTEMS.COM

ULTRASYSTEMS

CONDENSER AND COOLING TOWER

10000 S. 100th ST.

APRIL, WASHINGTON, D.C.

TEL: (301) 477-1000

FAX: (301) 477-1001

TELETYPE: (301) 477-1002

INTERNET: WWW.ULTRASYSTEMS.COM

WWW.ULTRASYSTEMS.COM

ULTRASYSTEMS

CONDENSER AND COOLING TOWER

10000 S. 100th ST.

APRIL, WASHINGTON, D.C.

TEL: (301) 477-1000

FAX: (301) 477-1001

TELETYPE: (301) 477-1002

INTERNET: WWW.ULTRASYSTEMS.COM

WWW.ULTRASYSTEMS.COM

ULTRASYSTEMS

CONDENSER AND COOLING TOWER

10000 S. 100th ST.

APRIL, WASHINGTON, D.C.

TEL: (301) 477-1000

FAX: (301) 477-1001

TELETYPE: (301) 477-1002

INTERNET: WWW.ULTRASYSTEMS.COM

WWW.ULTRASYSTEMS.COM

ULTRASYSTEMS

CONDENSER AND COOLING TOWER

10000 S. 100th ST.

APRIL, WASHINGTON, D.C.

TEL: (301) 477-1000

FAX: (301) 477-1001

TELETYPE: (301) 477-1002

INTERNET: WWW.ULTRASYSTEMS.COM

WWW.ULTRASYSTEMS.COM

ULTRASYSTEMS

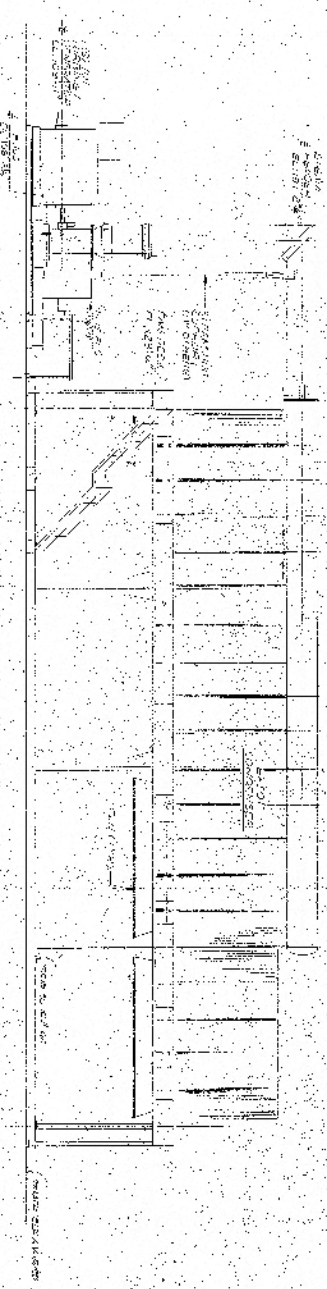

SECTION B

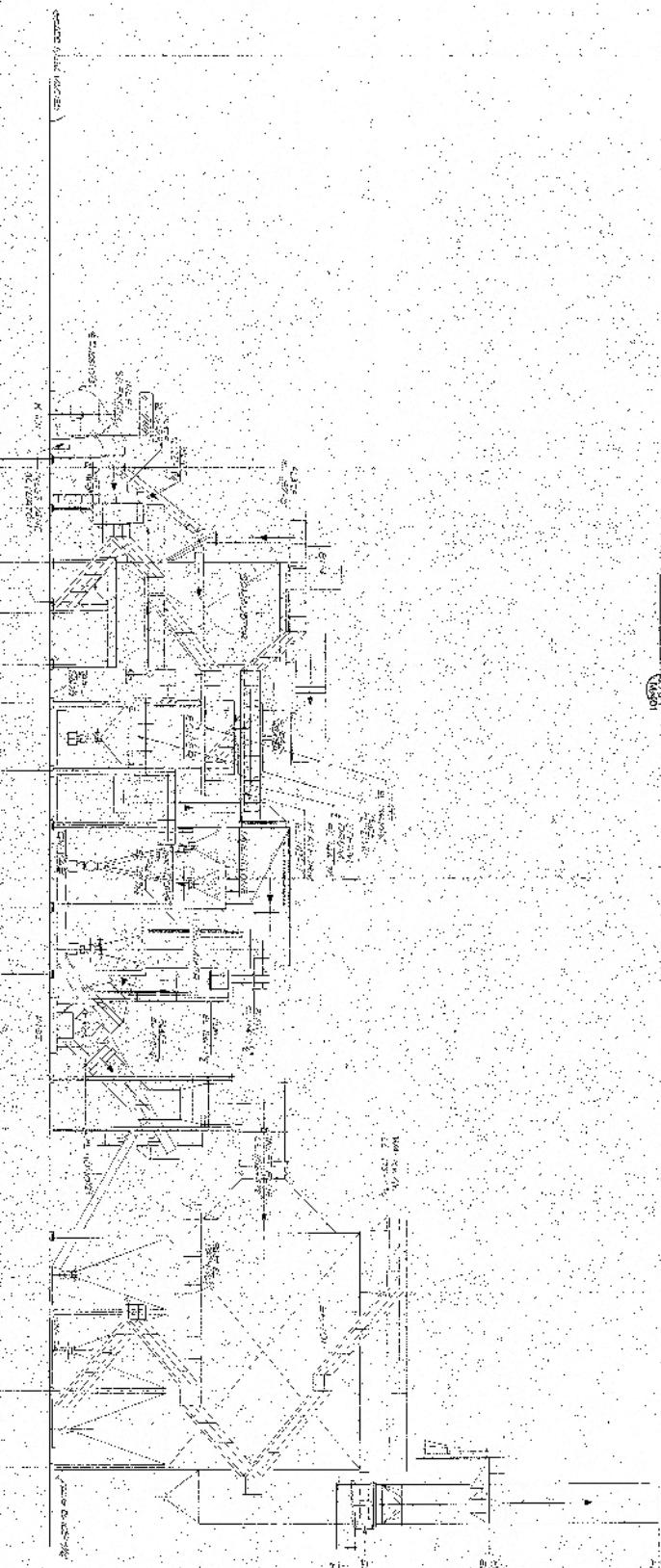

SECTION A

NOTES:  
 1. ALL DIMENSIONS ARE IN FEET AND INCHES.  
 2. ALL DIMENSIONS ARE TO FACE UNLESS OTHERWISE NOTED.  
 3. ALL DIMENSIONS ARE TO FACE UNLESS OTHERWISE NOTED.  
 4. ALL DIMENSIONS ARE TO FACE UNLESS OTHERWISE NOTED.

NO.	DATE	REVISIONS	BY	FOR
1				
2				
3				
4				
5				
6				
7				
8				
9				
10				

  

<b>ULTRABYTE</b> ARCHITECTS 1000 BAY STREET OAKLAND, CALIFORNIA 94612		<b>PACIFIC ULTRATOWER</b> 1000 BAY STREET OAKLAND, CALIFORNIA 94612	
PROJECT NO. M-155-04-402		DATE: MAY 14, 1980	

GENERAL ARRANGEMENT SECTIONS

MAY 14, 1980



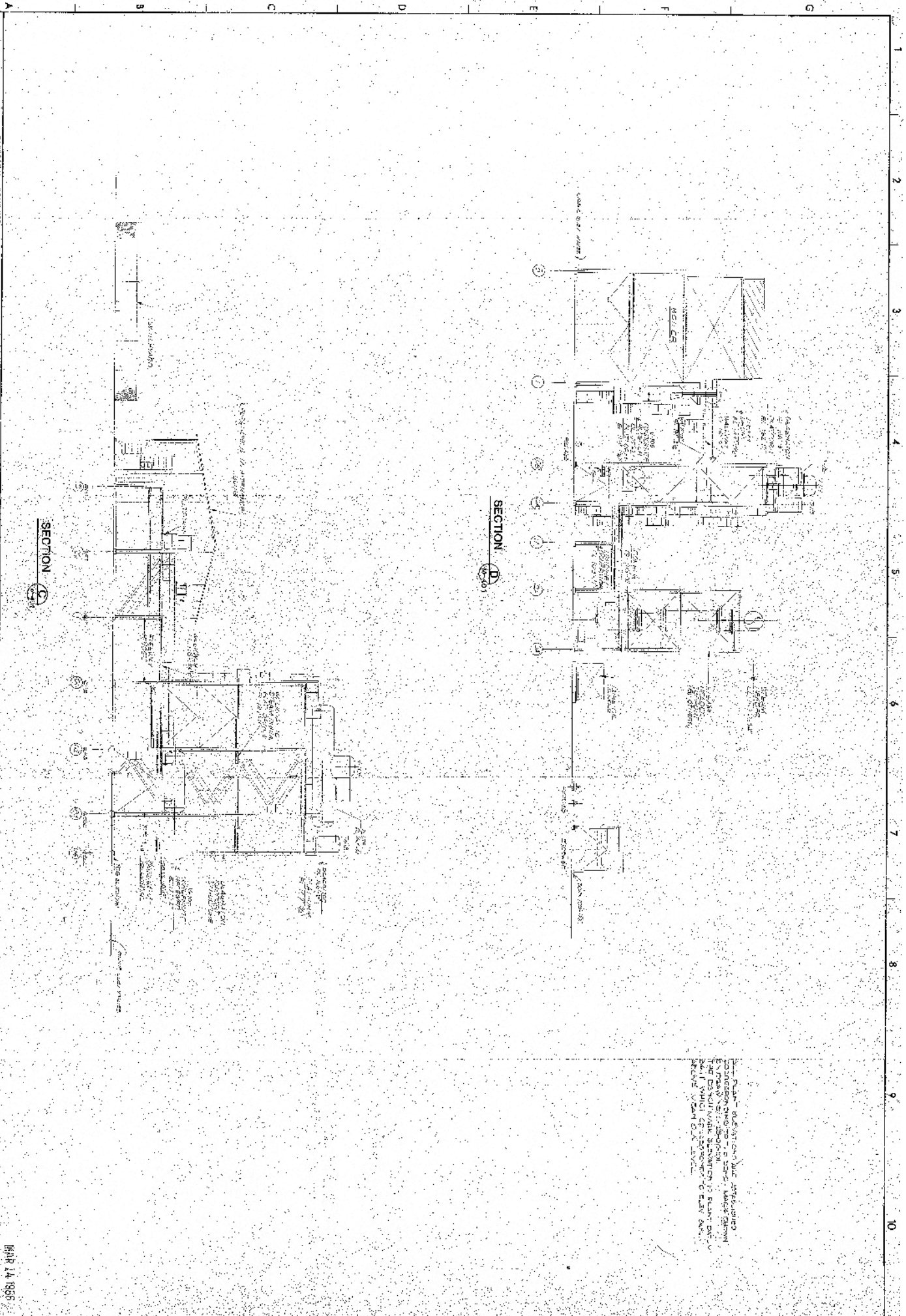

SECTION (D)

SECTION (C)

Notes:  
 1. All dimensions are in meters.  
 2. All elevations are in meters above sea level.  
 3. All materials are to be of standard quality.  
 4. All work is to be done in accordance with the specifications.  
 5. All work is to be done in accordance with the drawings.

GENERAL ARRANGEMENT SECTIONS		SECTIONS		SECTIONS		SECTIONS		SECTIONS	
NO.	DESCRIPTION	NO.	DESCRIPTION	NO.	DESCRIPTION	NO.	DESCRIPTION	NO.	DESCRIPTION
1	RECEPTION	1	OFFICE	1	RESTROOM	1	STATION	1	STATION
2	OFFICE	2	RESTROOM	2	STATION	2	STATION	2	STATION
3	RESTROOM	3	STATION	3	STATION	3	STATION	3	STATION
4	STATION	4	STATION	4	STATION	4	STATION	4	STATION
5	STATION	5	STATION	5	STATION	5	STATION	5	STATION
6	STATION	6	STATION	6	STATION	6	STATION	6	STATION
7	STATION	7	STATION	7	STATION	7	STATION	7	STATION
8	STATION	8	STATION	8	STATION	8	STATION	8	STATION
9	STATION	9	STATION	9	STATION	9	STATION	9	STATION
10	STATION	10	STATION	10	STATION	10	STATION	10	STATION

ULTRAS SYSTEMS

GENERAL ARRANGEMENT SECTIONS

CHINESE STATION CALIFORNIA

DATE 14.1986

EC-155

M-155-04-403

6/20/16 8:31 AM / user / e:\projects\trimark\12f3297\12f3297.dwg

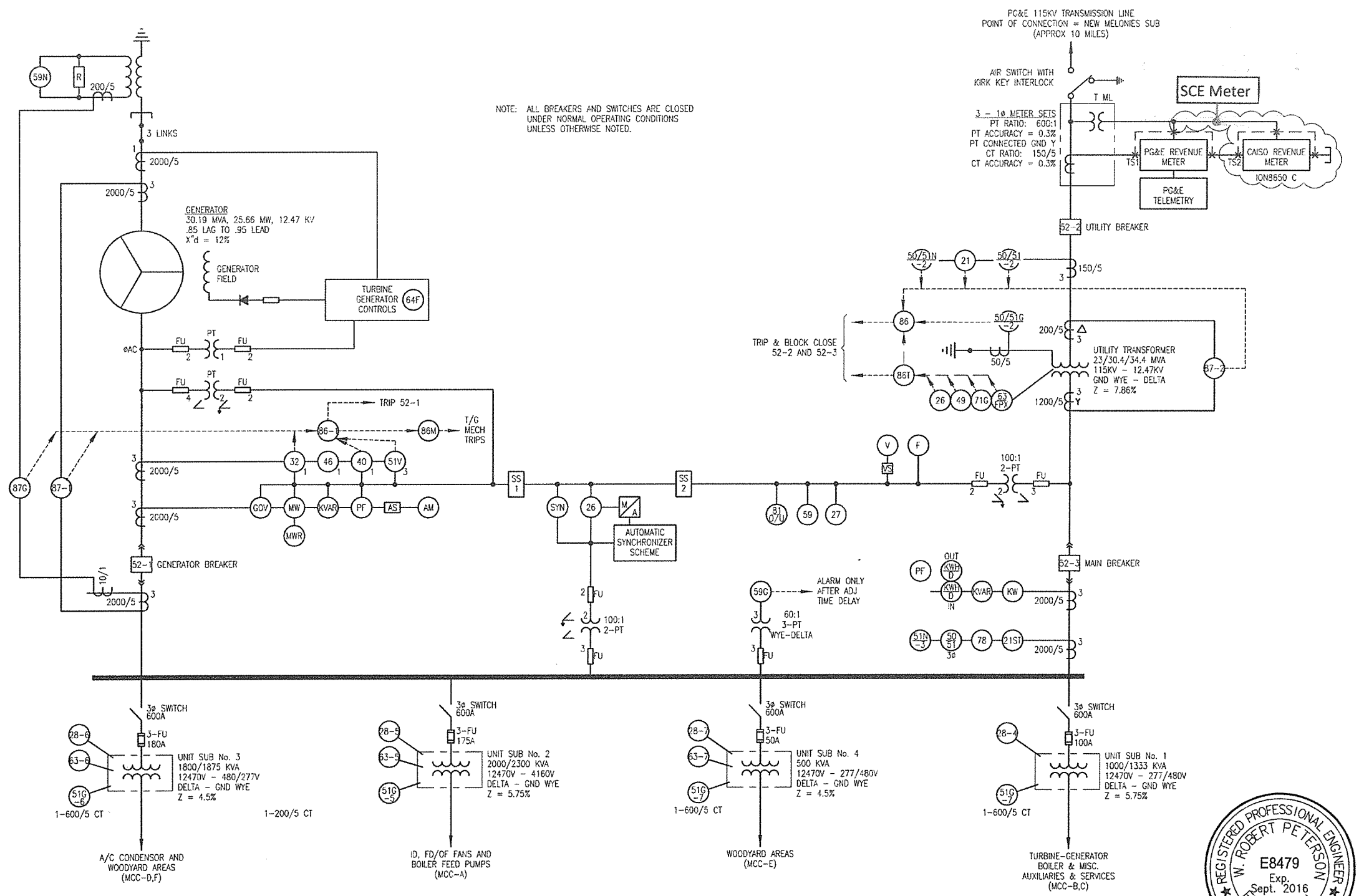

NOTE: ALL BREAKERS AND SWITCHES ARE CLOSED UNDER NORMAL OPERATING CONDITIONS UNLESS OTHERWISE NOTED.

**Trimark**

2365 Iron Point Road, Suite 100  
Folsom, CA 95630  
916.357.5970

9600 Topanga Canyon Boulevard, Suite 100  
Chatsworth, CA 91311  
818.963.4695

www.TrimarkAssoc.com

CLIENT

**CHINESE STATION**

8755 Enterprise Drive  
Jamestown, CA 95370

PROJECT

**CAISO METER ADDITION**

GENERATION FACILITY

**ISSUED FOR CONSTRUCTION**

CAISO PROJECT NUMBER

REVISION HISTORY			
NO.	DATE	DESCRIPTION	BY
1	6/3/16	ISSUED FOR CONSTRUCTION	WRP

SHEET TITLE

**SINGLE-LINE DIAGRAM GENERATION FACILITY**

TRIMARK PROJECT NUMBER  
**12F3297**

DEPARTMENT APPROVALS	
PM	PL
ENG/DES	WRP
DRAWN	WRP
METER	
RIG	
MET	
PROD	

SHEET NUMBER  
**ISO-E1**

REVISION  
**1**

SCALE NO SCALE | SHEET 1 OF 1



---

*\*\*\* End of EXHIBIT B \*\*\**

## EXHIBIT C

### Notice List

<b>PACIFIC ULTRAPOWER CHINESE STATION</b> (“Seller”)	<b>SOUTHERN CALIFORNIA EDISON COMPANY (“SCE”)</b>
All Notices are deemed provided in accordance with Section 10.08 if made to the address and facsimile numbers provided below:	Unless otherwise specified, all Notices are deemed provided in accordance with Section 10.08 if made to the Contract Sponsor at the address or facsimile number provided below:
<b>Contract Sponsor:</b> Attn: Managing Partner  Street: 95 Enterprise #300 City: Aliso Viejo, CA 92656 Phone: 949-297-0845 Facsimile:	<b>Contract Sponsor:</b> Attn: Vice President of Energy Procurement & Management Street: 2244 Walnut Grove Avenue City: Rosemead, California 91770 Phone: 626-302-4023 Facsimile: 626-302-9622
<b>Reference Numbers:</b> Duns: NA Federal Tax ID Number: 33-0056137	<b>Reference Numbers:</b> Duns: 006908818 Federal Tax ID Number: 95-1240335
<b>Contract Administration:</b> Attn: Director, Commercial Operations Phone: 949-330-7977 Facsimile: 949-330-7961	<b>Contract Administration:</b> Attn: Director, Contract Management and Administration Phone: 626-302-3126 Facsimile: 626-302-8168 Email: Energycontracts@sce.com
<b>Forecasting:</b> Attn: Control Room Phone: 209-984-4660 x316 Facsimile: 209-984-3398	<b>Generation Operations Center:</b> Attn: Preschedule Operations Phone: 626-307-4487 or 626-307-4420 Facsimile: 626-302-3409 E-mail: presched@sce.com
<b>Day-Ahead Forecasting:</b>  Phone: 209-984-4660 x316 or x312	<b>Day-Ahead Scheduling:</b> Attn: Manager of Day-Ahead Operations Attn: Scheduling Desk Phone: 626-307-4425 or 626-307-4420 Facsimile: 626-307-4413 E-mail: presched@sce.com

The contents of this document are subject to restrictions on disclosure as set forth herein.

# Southern California Edison

Confidential Information

RAP ID #1242, Pacific Ultrapower Chinese Station

<b>PACIFIC ULTRAPOWER CHINESE STATION</b> (“Seller”)	<b>SOUTHERN CALIFORNIA EDISON COMPANY (“SCE”)</b>
<b>Real-Time Forecasting:</b>  Phone: 209-984-4660 x316 or x312	<b>Real-Time Scheduling:</b> Attn: Manager of Real-Time Operations Attn: Operations Desk Phone: 626-307-4405 or 626-307-4453 Facsimile: 626-307-4416 E-mail: realtime@sce.com
	<b>Short Term Planning:</b>
<b>Payment Invoices:</b> Attn: Director, Finance Phone: 949-330-7973 Facsimile: 949-330-7961 E-mail:	<b>Payment Invoices:</b> Attn: Power Procurement - S&OS Phone: 626-302-3277 or 626-302-8908 Facsimile: 626-302-3276 E-mail:PPFDPowerSettle@sce.com
<b>CAISO Costs and CAISO Sanctions and SCE Penalties:</b> Attn: Director, Commercial Operations Phone: 949-330-7977 Facsimile: 949-330-7961 E-mail:	<b>CAISO Costs, CAISO Sanctions and SCE Penalties:</b> Attn: Power Procurement - S&OS Phone: 626-302-3277 or 626-302-8908 Facsimile: 626-302-3276 E-mail:PPFDPowerSettle@sce.com
<b>Payments:</b> Attn: Director, Finance Phone: 949-330-7973 Facsimile: 949-330-7961 E-mail:	<b>Payments:</b> Attn: Power Procurement S&OS Phone: 626-302-3277 or 626-302-8908 Facsimile: 626-302-3276 E-mail:PPFDPowerSettle@sce.com
<b>Wire Transfer:</b> BNK: JP Morgan Chase ABA: 071000013 ACCT:686608597	<b>Wire Transfer:</b> BNK: JP Morgan Chase Bank ABA: 021000021 ACCT: 323-394434
<b>Credit and Collections:</b> Attn: Director, Finance Phone: 949-330-7973 Facsimile: 949-330-7961 E-mail:	<b>Credit and Collateral:</b> Attn: Manager of Credit and Collateral Phone: 626-302-3383 Facsimile: 626-569-2551 Email: scecollateral@sce.com

The contents of this document are subject to restrictions on disclosure as set forth herein.

<b>PACIFIC ULTRAPOWER CHINESE STATION</b> ("Seller")	<b>SOUTHERN CALIFORNIA EDISON COMPANY ("SCE")</b>
<b>With additional Notices of an Event of Default or Potential Event of Default to:</b> Attn: Director, Commercial Operations Phone: 949-330-7977 Facsimile: 949-330-7961 E-mail:	<b>With additional Notices of an Event of Default or Potential Event of Default to:</b> Attn: Manager SCE Law Department Power Procurement Section Phone: 626-302-6897 Facsimile: 626-302-1935
<b>Lender:</b> Attn: Phone: Facsimile: E-mail:	

\*\*\* End of EXHIBIT C \*\*\*

**EXHIBIT D***Forecasting and Scheduling Requirements and Procedures*1. Introduction.

The Parties shall abide by the Forecasting and Scheduling requirements and procedures described below and shall agree upon reasonable changes to these requirements and procedures from time-to-time, as necessary to:

- (a) Comply with CAISO Tariff;
- (b) Accommodate changes to their respective generation technology and organizational structure; and
- (c) Address changes in the operating and Scheduling procedures of both SCE and the CAISO, including but not limited to, automated forecast and outage submissions.

2. Seller's Forecasting Requirements.

Seller must meet all of the following requirements for Forecasting as specified below.

- (a) No later than thirty (30) days before any day designated for Commercial Operation, Seller shall provide SCE, via the Web Client, with a 30-day, hourly Forecast of either or both:
  - (i) Capacity, in MW; or
  - (ii) Electric energy, in MWhas directed by SCE, for the thirty (30) day period commencing on the Commercial Operation Date.
- (b) If, after submitting the Forecast pursuant to Item 2(a), Seller learns that Commercial Operation will occur on a date and time other than that reflected on the Forecast, Seller shall provide an updated Forecast reflecting the new Commercial Operation Date at the earliest practicable time but no later than 5:00 p.m. Pacific Prevailing Time ("PPT") on the Wednesday before the revised Commercial Operation Date, if Seller has learned of the new Commercial Operation Date by that time, but in no event less than three (3) Business Days before the actual Commercial Operation Date.
- (c) If the Web Client becomes unavailable, Seller shall provide SCE with the Forecast by e-mailing SCE.
- (d) The Forecast, and any updated Forecasts provided pursuant to this Item 2, must:
  - (i) Not include any anticipated or expected electric energy losses after the CAISO Approved Meter or Check Meter; and

*The contents of this document are subject to restrictions on disclosure as set forth herein.*

- (ii) Limit hour-to-hour Forecast changes to no less than two hundred fifty (250) kWh or 0.25 MW, as applicable, during any period when the Web Client is unavailable. Seller shall have no restriction on hour-to-hour Forecast changes when the Web Client is available.
- (e) Commencing on or before 5:00 p.m. PPT of the Wednesday before the first week covered by the Forecast provided pursuant to Item 2(a) above and on or before 5:00 p.m. PPT every Wednesday thereafter until the end of the Delivery Term, Seller shall update the Forecast for the thirty (30) day period commencing on the Sunday following the weekly Wednesday Forecast update submission. Seller shall use the Web Client, if available, to supply this weekly update or, if the Web Client is not available, Seller shall provide SCE with the weekly Forecast update by e-mailing SCE.
- (f) Forecasting Electric Energy.

If Seller is Forecasting electric energy, in accordance with SCE's instructions, and Seller learns of any change in the total electrical energy output of the Generating Facility for a period covered by the most recent Forecast update resulting from any cause, including an unplanned outage, before the time that the next weekly update of the Forecast is due which results in variance in expected energy in any hour of plus (+) or minus (-) three percent (3%) from the energy reported in the most recent Forecast update, Seller shall provide an updated Forecast to SCE. This updated Forecast must be submitted to SCE by no later than:

  - (i) 5:00 a.m. PPT on the day before any day impacted by the change, if the change is known to Seller at that time. If the Web Client is not available, Seller shall e-mail these changes to [presched@sce.com](mailto:presched@sce.com) and immediately follow up with a phone call to SCE's Day-Ahead Scheduling Desk in accordance with Exhibit C;
  - (ii) Thirty (30) minutes before the commencement of any hour impacted by the change, if the change is known to Seller at that time; or
  - (iii) If the change is not known to Seller by the timeframes indicated in (i) or (ii) above, within twenty (20) minutes after Seller became aware or, using best efforts, should have become aware of the commencement of the event which caused the energy forecast change, e-mail changes to [realtime@sce.com](mailto:realtime@sce.com) and immediately telephone SCE's Real-time Operations Desk in accordance with Exhibit C.
- (g) Forecasting Available Capacity.

If:

  - (i) Seller is Forecasting available capacity, in accordance with SCE's instructions;

*The contents of this document are subject to restrictions on disclosure as set forth herein.*



- (ii) Seller does not provide real-time communication of availability as provided in Section 3.08(g);
- (iii) The telecommunications path to obtain real-time data is inoperable; or
- (iv) Instrumentation is providing faulty or incorrect data; and

Seller learns of any change in the total available capacity of the Generating Facility for a period covered by the most recent Forecast update resulting from any cause, including an unplanned outage before the time that the next weekly update of the Forecast is due which Seller is required to report under the provisions of the CAISO Tariff related to PIRP/EIRP and under other applicable provisions of the CAISO Tariff related to availability and outage reporting, then Seller shall provide an updated Forecast to SCE. This updated Forecast must be submitted to SCE via the Web Client by no later than:

- (1) 5:00 a.m. PPT on the day before any day impacted by the change, if the change is known to Seller at that time. If the Web Client is not available, Seller shall e-mail these changes to [presched@sce.com](mailto:presched@sce.com) and immediately follow up with a phone call to SCE's Day-Ahead Scheduling Desk in accordance with Exhibit C;
  - (2) Thirty (30) minutes before the commencement of any hour impacted by the change, if the change is known to Seller at that time; or
  - (3) If the change is not known to Seller by the timeframes indicated in (1) or (2) above, within twenty (20) minutes after Seller becomes aware or, using best efforts, should have become aware of the event which caused the availability change, e-mail changes to [realtime@sce.com](mailto:realtime@sce.com) and immediately telephone SCE's Real-time Operations Desk in accordance with Exhibit C.
- (h) Seller's updated Forecast must reflect the following information:
- (i) The beginning date and time of the change;
  - (ii) The expected ending date and time of the event;
  - (iii) The expected availability, in MW (if so instructed by SCE);
  - (iv) The expected energy, in MWh (if so instructed by SCE); and
  - (v) Any other information required by the CAISO as communicated to Seller by SCE.

3. SCE's Scheduling Responsibilities.

SCE shall be responsible for Scheduling the Product in accordance with this Agreement.

*RAP ID #1242, Pacific Ultrapower Chinese Station*

4. Seller's Outage Scheduling Requirements.

Seller shall meet all requirements and timelines for generation outage scheduling contained in the CAISO's Scheduled and Forced Outage Procedure T-113, or its successor, as posted on the CAISO's website.

---

*\*\*\* End of EXHIBIT D \*\*\**

*The contents of this document are subject to restrictions on disclosure as set forth herein.*

**EXHIBIT E***Payments and Invoicing***1. COST RESPONSIBILITY, INVOICING AND PAYMENTS UPON COMMENCEMENT OF THE TERM****1.01 Cost Responsibility Upon Commercial Operation.****(a) SCE Cost Responsibility.**

Upon the Commercial Operation Date and for the remainder of the Term,

- (i) Except under the circumstances set forth in Section 4.01(e), SCE shall make monthly Product Payments to Seller for Product delivered to SCE calculated in the manner described in Section 1.02 below and Exhibit M;
- (ii) Except as set forth in Exhibit M and Section 1.01(b) of Exhibit E, SCE shall be responsible for all CAISO Costs and CAISO Sanctions and have the right to receive all CAISO Revenues;

**(b) Seller Cost Responsibility.**

Upon the Commercial Operation Date and for the remainder of the Term:

- (i) [Intentionally Deleted.]
- (ii) Seller shall be responsible for CAISO Costs and CAISO Sanctions, under the circumstances specified in Section 4.01(e) and RA Deficit Payments under the circumstances specified in Section 3.02.
- (iii) Seller shall be responsible for Negative LMP Costs, if applicable, as set forth in Section 1.05(c)(i).
- (iv) Seller shall be responsible for CAISO Costs and CAISO Sanctions and receive CAISO Revenues under the circumstances specified in Section 1.05(c)(ii).
- (v) Seller shall make monthly payments calculated in the manner described in Section 1.02 below and Exhibit M.

**1.02 Product Payment Calculations After Commercial Operation Date.**

For the purpose of calculating monthly payments for Product delivered to SCE as of the Commercial Operation Date in accordance with the terms of this Agreement (“Product Payments”), Qualified Amounts will be time-differentiated according to the TOD Periods set forth in Exhibit I and the pricing will be weighted by the Product Payment Allocation Factors.

Monthly Product Payments will equal the sum of (i) the sum of the TOD Period Product Payments for all TOD Periods in the month and (ii) the Curtailed Product Payment. Each TOD Period Product Payment will be calculated pursuant to the following formula, where “n” is the TOD Period being calculated:

*The contents of this document are subject to restrictions on disclosure as set forth herein.*

$$\text{TOD PERIOD}_n \text{ PRODUCT PAYMENT} = A \times B \times (C - D - E) + F$$

Where:

- A = Product Price specified in Section 1.05 in \$/kWh (i.e., \$/MWh/1000).
- B = Product Payment Allocation Factor for the TOD Period being calculated.
- C = The sum of Qualified Amounts in all hours for the TOD Period being calculated in kWh.
- D = Any electric energy produced by the Generating Facility for which SCE is not obligated to pay Seller as set forth in Section 4.01(e).
- E = Any electric energy produced by the Generating Facility with respect to which Seller is entitled to CAISO Revenues as set forth in Section 1.05(c)(ii).
- F = CAISO Revenues with respect to electric energy produced by the Generating Facility for which Seller is entitled to CAISO Revenues as set forth in Section 1.05(c)(ii).

### 1.03 Payment During the Term.

On or before the last Business Day of the month following the applicable month for which the monthly Product Payment is being calculated, SCE shall:

- (a) Issue a Payment Invoice to Seller, including documentation supporting any SCE Penalties, Negative LMP Costs, CAISO Costs, CAISO Sanctions, RA Deficit Payments pursuant to Section 3.02, or other applicable revenues, charges and offsets which affected the net amount in the Payment Invoice; and
- (b) Send to Seller, via wire transfer or Automated Clearing House, SCE's payment of said net amount, less any applicable SCE Penalties, Negative LMP Costs, CAISO Costs, CAISO Sanctions, RA Deficit Payments pursuant to Section 3.02, or other applicable charges or offsets plus, if such payment is late, a Simple Interest Payment calculated using the Interest Rate and the number of days that such payment is late.

The Parties acknowledge that data necessary to calculate certain payment obligations of Buyer and Seller under this Agreement may not be available at the time SCE issues the Payment Invoice with respect to a particular month. Any such payment obligations, including related documentation supporting such obligations, shall be included in a subsequent Payment Invoice issued to Seller on or before the last Business Day of the month following the month that is the later of (i) one hundred and twenty (120) days following the last day of the calendar month to which the data relates or (ii) thirty (30) days after the relevant CAISO final settlement data is available to SCE.

### 1.04 Recomputation and Payment Adjustments.

*The contents of this document are subject to restrictions on disclosure as set forth herein.*

- (a) If Seller or SCE determines that a calculation of Qualified Amounts, Metered Amounts, CAISO Revenues, Negative LMP Costs, CAISO Costs, CAISO Sanctions, RA Deficit Payments, or SCE Penalties is incorrect as a result of inaccurate meters, the correction of data by the CAISO in OMAR, or a recalculation of CAISO Sanctions or other amounts owing between the Parties, Seller or SCE, as the case may be, shall promptly recompute the Qualified Amounts, Metered Amounts, CAISO Revenues, Negative LMP Costs, CAISO Costs, CAISO Sanctions, RA Deficit Payments, SCE Penalties or other amounts for the period of the inaccuracy based upon an adjustment of inaccurate meter readings, correction of data or recalculation of CAISO Sanctions in accordance with the CAISO Tariff and any payment affected by the adjustment or correction.

(b) Adjustment of Payment.

Any amount due from SCE to Seller, or Seller to SCE, as the case may be, will be made as an adjustment to the next monthly Payment Invoice that is calculated after Seller's or SCE's recomputation using corrected measurements.

If the recomputation results in a net amount owed to SCE after applying any amounts owing to Seller as shown on the next monthly Payment Invoice, any such amount owing to SCE will at SCE's discretion be netted against amounts owed to Seller in any subsequent monthly Payment Invoice or separately invoiced to Seller, in which case Seller must pay the amount owing to SCE within twenty (20) days after receipt of that invoice.

SCE may make payment adjustments arising from a recalculation of CAISO Revenues, CAISO Costs, Negative LMP Costs, CAISO Sanctions, RA Deficit Payments, SCE Penalties, or as a result of inaccurate meters after the end of the Term Year, provided, the Parties will be deemed to have waived any such payment adjustments which are not communicated as provided in this Section 2.04 of this Exhibit E within twelve (12) months after the end of the month in which the Payment Invoice was issued containing the error. Adjustment payments for meter inaccuracy will not bear interest.

1.05 Netting Rights.

SCE reserves the right to net amounts that would otherwise be due to Seller under this Agreement in payment of any amounts:

- (a) Owing and unpaid by Seller to SCE under this Agreement; or  
(b) Owed to SCE by Seller arising out of, or related to, any other SCE agreement, tariff, obligation or liability.

Nothing in this Section 1.05 of this Exhibit E limits SCE's rights under applicable tariffs, other agreements or Applicable Law.

**2. PAYMENT ERRORS**

2.01 Notice of Error in Payment.

Except as provided in Section 1.04 of this Exhibit E, if within forty-five (45) days after receipt of SCE's Payment, Seller does not give SCE Notice of an error in the payment amount, then Seller will be deemed to have waived any error in the payment.

## 2.02 Reimbursement for Underpayments and Overpayments.

If Seller identifies a payment error in Seller's favor and SCE agrees that the identified error occurred, SCE shall reimburse Seller for the amount of the underpayment caused by the error and apply the additional payment to the next monthly Payment Invoice that is calculated.

If Seller identifies a payment error in SCE's favor and SCE agrees that the identified error occurred, SCE may net the amount of overpayment caused by the error against amounts otherwise owed to Seller in connection with the next monthly Payment Invoice that is calculated.

## 2.03 Late Payments.

Late payments to Seller resulting from SCE's errors, or overpayments to Seller by SCE, will include a Simple Interest Payment calculated using the Interest Rate and the number of days between the date due (or, in the case of overpayments by SCE, commencing five (5) Business Days from the date SCE provides Notice of such overpayments to Seller) and the date paid; *provided*, changes made because of settlement, audit or other information provided by the CAISO and not available to SCE when SCE rendered its original Payment Invoice will not bear interest.

## 2.04 Netting after Recomputation.

If the recomputation for an error results in a net amount still owing to SCE after applying the amounts owed to SCE against any amounts owed to Seller in the Payment Invoice, as described above, then SCE may, in its discretion, either net this net remaining amount owed to SCE against amounts owed to Seller in any subsequent monthly Payment Invoice to Seller or invoice Seller for such amount, in which case Seller must pay the amount owing to SCE within twenty (20) days after receipt of such invoice.

## 2.05 Resolution of Disputes.

The Parties shall negotiate in good faith to resolve any disputes regarding claimed errors in a Payment. Any disputes which the Parties are unable to resolve through negotiation may be submitted for resolution through the mediation and arbitration as provided in Article Twelve. Upon resolution of the Dispute, any required payment shall be made within ten (10) Business Days of such resolution along with a Simple Interest Payment calculated using the Interest Rate from and including the due date but excluding the date paid.

*\*\*\* End of EXHIBIT E \*\*\**

**EXHIBIT F***Product Replacement Damage Amount*

In accordance with the provisions of Section 3.07, if in any Term Year an Event of Deficient Energy Deliveries occurs over the Calculation Period, then Seller shall be subject to a Product Replacement Damage Amount penalty calculated as follows:

PRODUCT REPLACEMENT DAMAGE AMOUNT =

$$(A - B - C) \times (D - E)$$

Where:

- A = Seller's Annual Energy Delivery Obligation in kWh.
- B = Sum of Qualified Amounts over the Term Year in kWh.
- C = Sum of Lost Output over the Term Year in kWh.
- D = Simple average of the Green Market Price for all Settlement Intervals in the Term Year in \$/kWh.
- E = Product Price in Section 1.05(a), in \$/kWh (i.e., \$/MWh/1000).

Notes:

1. In the above calculation, the result of "(D - E)" will not be greater than five cents (\$0.05) per kWh or less than two cents (\$0.02) per kWh.
2. In no event will SCE pay a Product Replacement Damage Amount.

---

\*\*\* End of EXHIBIT F \*\*\*



**EXHIBIT G***Seller's Milestone Schedule and Material Permits***Seller's Milestone Schedule**

<i>No.</i>	<i>Date</i>	<i>Milestones</i>
1	n/a	Submits interconnection application.
2	n/a	Files any land applications.
3	n/a	Files Construction Permit application(s).
4	n/a	Files a CEC Pre-Certification application.
5	n/a	Files Material Permit applications.
6	n/a	Receives a completed System Impact Study or Phase I Interconnection Study.
7	n/a	Obtains control of all lands and rights-of-way comprising the Site.
8	n/a	Receives a completed interconnection Facility Study or Phase II Interconnection Study.
9	n/a	Executes an interconnection agreement and transmission/distribution service agreement, as applicable.
10	n/a	Receives FERC acceptance of interconnection agreement and transmission agreement.
11	n/a	Receives Construction Permit.
12	n/a	Receives Material Permits.
13	n/a	Receives CEC Pre-Certification.
14	n/a	Executes an Engineering, Procurement and Construction ("EPC") contract.
15	n/a	Procures the applicable electrical generating equipment for the Generating Facility.
16	n/a	Completes financing, including construction financing.
17	n/a	Begins construction of the Generating Facility.
18	n/a	Begins startup activities.
19	3/1/2017	Commercial Operation Date.
20	3/30/2017	Demonstrates the Contract Capacity
21	n/a	Receives CEC Certification.

*The contents of this document are subject to restrictions on disclosure as set forth herein.*

Seller’s Material Permits

<i>No.</i>	<i>Permits</i>
1	Conditional Use Permit – County of Tuolumne Board of Supervisors
2	Permit to Operate – Tuolumne County Air Pollution Control District (PCAPCD)
3	Notice of Intent for coverage under General Permit to Discharge Storm Water Associated with Industrial Activity – State Water Resources Control Board (SWRCB)
4	Permits to Operate Air Pressure Tanks – California Department of Industrial Relations (CDIR): Tank No. A014436-87 Tank No. L022613-86
5	Permit to Operate Steam Boiler - CDIR
6	Weighmaster License – California Department of Food & Agricultural
7	Scale Device Registration – Tuolumne County Agricultural Commission
8	Certificate of Occupancy – Tuolumne County Department of Public Works
9	Notice of Self Recertification – Federal Energy Regulatory Commission (FERC)
10	Tuolumne County Environmental Health – Permit to Operate PT0000909 CalARP Site Annual PT0001156 Hazardous Waste Medium Qtr Gen w/Business Plan PT0002695 Haz-Mat Business Plan – Lrg Over 12 Chemicals PT0002696 AST>660gal/<10,000 gallons
11	Title V Operating Permit – TCAPCD
12	
13	
14	
15	

\*\*\* End of EXHIBIT G \*\*\*

*The contents of this document are subject to restrictions on disclosure as set forth herein.*

**EXHIBIT H***Milestone Progress Reporting Form*

Seller shall prepare a written report each month on its progress relative to the development construction and startup of the Generating Facility and the Milestone Schedule. The report must be sent via e-mail in the form of a single Adobe Acrobat file or facsimile to SCE's Contract Administrator, as noted in Exhibit C, on the fifth (5th) Business Day after each month.

Seller's obligation to complete a Milestone Progress Reporting Form for the preceding month and submit such report to SCE begins on the first day of the first full calendar month after the Effective Date of this Agreement and ends immediately after a Milestone Progress Reporting Form is completed and submitted for the month following the month in which Seller demonstrates the Contract Capacity in accordance with Exhibit J.

Each Milestone Progress Report must include the following items:

1. Cover page.
2. Brief Generating Facility description.
3. Site plan of the Generating Facility.
4. Description of any planned changes to the Generating Facility and Site Description in Exhibit B.
5. Bar chart schedule showing progress on achieving the Milestone Schedule.
6. PERT or GANT chart showing critical path schedule of major items and activities.
7. Summary of activities during the previous month.
8. Forecast of activities scheduled for the current month.
9. Written description about the progress relative to Seller's Milestone Schedule.
10. List of issues that could potentially impact Seller's Milestone Schedule.
11. Enumeration and schedule of any support or actions requested of SCE.
12. Progress and schedule of all agreements, contracts, Permits, approvals, technical studies, financing agreements and major equipment purchase orders showing the start dates, completion dates, and completion percentages.
13. A status report of start-up activities including a forecast of activities ongoing and after start-up, a report on Generating Facility performance including performance projections for the next twelve (12) months.
14. Pictures, in sufficient quantity and of appropriate detail, in order to document construction and startup progress of the Generating Facility, Transmission Provider's electric system and all other interconnection utility services.

---

\*\*\* End of EXHIBIT H \*\*\*

*The contents of this document are subject to restrictions on disclosure as set forth herein.*



**EXHIBIT I**  
*Time of Delivery Periods  
 and  
 Product Payment Allocation Factors*

<u>Time of Delivery Periods (“TOD Periods”)</u>		
<i>TOD Period</i>	<i>Time of Day</i>	<i>Applicable Days</i>
On-Peak	2:00 p.m. – 8:00 p.m.	Weekdays except Holidays.
Off-Peak	8:00 a.m. – 2:00 p.m.	Weekdays, Weekends and Holidays
	2:00 p.m. – 8:00 p.m.	Weekends and Holidays.
	8:00 p.m. – 10:00 p.m.	Weekdays, Weekends and Holidays
Super-Off-Peak	10:00 p.m. – 8:00 a.m.	Weekdays, Weekends and Holidays

<u>Product Payment Allocation Factors</u>		
<i>Season</i>	<i>TOD Period</i>	<i>Product Payment Allocation Factor</i>
Summer <i>Jun 1<sup>st</sup> – Sep 30<sup>th</sup></i>	On-Peak	1.35
	Off-Peak	1.08
	Super-Off-Peak	0.86
Winter <i>Oct 1<sup>st</sup> – May 31<sup>st</sup></i>	On-Peak	1.18
	Off-Peak	1.02
	Super-Off-Peak	0.86

“Holiday” is defined as New Year’s Day, Presidents’ Day, Memorial Day, Independence Day, Labor Day, Veterans Day, Thanksgiving Day, and Christmas Day.

When any Holiday falls on a Sunday, the following Monday will be recognized as a Holiday. No change will be made for Holidays falling on Saturday.

\*\*\* *End of EXHIBIT I* \*\*\*

*The contents of this document are subject to restrictions on disclosure as set forth herein.*

**EXHIBIT J***Procedure for Demonstration of Contract Capacity and  
Partial or Full Return of Development Security*1. Seller's Notice of Demonstration Hour.

Seller shall provide Notice to SCE of the date and hour selected by Seller, which hour must have occurred within thirty (30) days following the Commercial Operation Date, during which Seller claims it has demonstrated the applicable Contract Capacity ("Demonstration Hour").

2. Demonstration of Contract Capacity.

- (a) Unless SCE provides timely Notice to Seller that additional days are required to substantiate data, SCE shall, within thirty (30) days after Seller's Notice of the Demonstration Hour, retrieve interval data downloaded from the CAISO Approved Meter or Check Meter for the twelve (12) hour periods before and after the Demonstration Hour; and
- (b) SCE may, at its sole discretion, complete a site visit within thirty (30) days after SCE's receipt of Seller's Notice of the Demonstration Hour to verify that the Generating Facility was developed in accordance with the Generating Facility and Site Description set forth in Exhibit B.

3. Full or Partial Return of Development Security for Demonstrating Contract Capacity.

Unless SCE provides timely Notice to Seller that additional days are required to substantiate data, SCE shall within ten (10) Business Days after SCE's site visit pursuant to Section 2 of this Exhibit J:

- (a) Calculate the amount of Development Security refund due Seller pursuant to Sections 3.06(e) and 3.06(f);
- (b) Provide Notice to Seller of (i) the amount of the Demonstrated Contract Capacity, and (ii) the amount of Development Security being returned pursuant to this Section 3;
- (c) Return any Development Security due Seller if such Development Security were posted in the form of cash; and
- (d) Return the Letter of Credit to the issuing bank if the total amount of the posted Development Security is due Seller. If Seller is only entitled to a partial return of the Development Security SCE shall submit a drawing certificate on the Letter of Credit for the amount of Development Security forfeited by Seller, after which SCE shall release the remaining balance of the Letter of Credit.

To the extent Seller has posted Development Security in accordance with Section 3.06 and Seller is entitled to a partial return of the Development Security, SCE shall return

*The contents of this document are subject to restrictions on disclosure as set forth herein.*

*RAP ID #1242, Pacific Ultrapower Chinese Station*

only a portion of the Development Security based upon the level of the Demonstrated Contract Capacity.

---

*\*\*\* End of EXHIBIT J \*\*\**

*The contents of this document are subject to restrictions on disclosure as set forth herein.*

---

**EXHIBIT K***Seller's Estimate of Lost Output*

Lost Output, as used in Section 3.21, shall be estimated by Seller in accordance with the procedures described in this Exhibit K.

Seller shall (1) collect the measurement data and perform the engineering calculations specified below in one (1) or more Microsoft Excel Workbooks (the "Lost Output Workbook") provided in a form and naming convention approved by SCE and (2) electronically send the Lost Output Workbook to an address provided by SCE.

SCE shall have the right to verify all data by inspecting measurement instruments and reviewing Generating Facility Operating records.

Seller shall update the Lost Output Workbook each month and shall include the latest revision of the Lost Output Workbook with its monthly Lost Output Report.

1. Log of Lost Output Events.

The log shall be kept on a single Worksheet in the Lost Output Workbook. Such log shall identify the date, time, duration, cause and amount by which the Generating Facility's output was curtailed for each Lost Output Event.

2. Data Collection.

Seller shall record all hourly Metered Amounts, during the Term, in the Lost Output Workbook on a single worksheet labeled "Metered Amounts".

The worksheet shall be arranged with:

- (a) One (1) column for the date;
- (b) One (1) column for the time;
- (c) One (1) column for the weekday;
- (d) One (1) column for the recorded Metered Amounts for each Term Year; and
- (e) One (1) row for each one (1) hour period during the Term Year.

Seller shall also identify, on a worksheet labeled "Lost Output Hours" and organized in a manner similar to the Metered Amounts worksheet described above, all hours when the Generating Facility's Metered Amounts were reduced due to any of the conditions or occurrences enumerated in the definition of Lost Output.

3. Generating Facility Monthly Profiles.

Seller shall create a profile of the estimated Generating Facility's Metered Amounts during an average week of each month during the Term (the "Monthly Profile").

Monthly Profiles shall include the seven (7) day period beginning at midnight on Sunday and ending at midnight on the following Saturday. They shall have a total of 168 average



hourly Metered Amount periods (i.e., 7 days times 24 hours per day equals 168 hourly periods).

Each Monthly Profile shall be created by averaging the Metered Amounts during the same one (1) hour interval of each day of the week within the month of the current Term Year and up to the three preceding Term Years, if available.

All hours during which the Generating Facility's Metered Amounts were reduced due to any of the conditions or occurrences enumerated in the definition of Lost Output must be removed from the Monthly Profile.

If a Monthly Profile is incomplete because of missing hourly averages or if more than one half (1/2) of the one (1) hour averages are calculated using less than three (3) hourly Metered Amounts, the Monthly Profile for that month shall be based upon a comparable winter season or summer season month, as appropriate, agreed upon by the Parties for the Term Year in which the Lost Output amount is being calculated.

All Term Year Monthly Profiles, for the same calendar month, shall be calculated on a worksheet dedicated to that month.

Worksheets shall be labeled "Jan Profile," "Feb Profile," etc. Each of the twelve (12) profile worksheets shall have one (1) column for the weekday, one (1) column for the time, one (1) column for each Term Year Monthly Profile and one (1) row for each of the one hundred sixty-eight (168) hourly periods.

Seller shall also create twelve (12) line charts, one for each calendar month, on dedicated worksheets formatted with the charts sized to fit on the worksheet. Each chart shall include one data series for each Term Year. Chart sheets shall be labeled "Jan Chart," "Feb Chart," etc.

4. Seller's Estimate of Lost Output.

Lost Output shall be estimated by Seller for all Term Years on one worksheet labeled "Lost Output Events".

The worksheet shall include:

- (a) One (1) column for the date;
- (b) One (1) column for the time;
- (c) One (1) column for the weekday;
- (d) One (1) column for Seller's Lost Output estimate for each Term Year; and
- (e) One (1) row for each one (1) hour period during the Term Year.

Seller's estimate of Lost Output, for any hour during which the Generating Facility was not offline due to any of the conditions or occurrences enumerated in the definition of Lost Output shall be equal to the Metered Amount average included in the Monthly Profile for the same hour, of the same weekday, of the month in the same Term Year in which the Lost Output Event occurred less any Metered Amounts during the hour.

Seller shall summarize its Lost Output calculation results on a one (1) worksheet that has one (1) column for the month, one (1) column for each Term Year and one (1) row for each calendar month. Seller's claim for Lost Output, at the end of any Term Year, shall be equal to the sum of the monthly Lost Output amounts, for the appropriate Term Year column, on this summary worksheet. This worksheet shall be labeled "Lost Output Summary."

SCE reserves the right to recalculate any Lost Output estimated by Seller.

---

\*\*\* End of EXHIBIT K \*\*\*

**EXHIBIT L**

*Form of Letter of Credit*

IRREVOCABLE NON-TRANSFERABLE STANDBY

LETTER OF CREDIT

Reference Number:

Transaction Date:

BENEFICIARY:

Southern California Edison Company

2244 Walnut Grove Avenue

Risk Control GO#1, Quad 1D

Rosemead, CA 91770

Ladies and Gentlemen:

\_\_\_\_\_ (the "Bank") hereby establishes this Irrevocable Non-transferable Standby Letter of Credit ("Letter of Credit") in favor of Southern California Edison Company, a California corporation (the "Beneficiary"), for the account of \_\_\_\_\_, a \_\_\_\_\_ corporation, also known as RAP ID# \_\_\_\_ (the "Applicant"), for the amount of XXX AND XX/100 Dollars (\$\_\_\_\_\_) (the "Available Amount"), effective immediately.

This Letter of Credit shall be of no further force or effect at 5:00 p.m., California time, on [Date] or, if such day is not a Business Day (as hereinafter defined), on the next Business Day (as may be extended pursuant to the terms of this Letter of Credit, the "Expiration Date").

For the purposes hereof, "Business Day" shall mean any day on which commercial banks are not authorized or required to close in Los Angeles, California.

It is a condition of this Letter of Credit that it shall be deemed automatically extended without amendment for a one year period (or, if such period ends on a day that is not a Business Day, until the next Business Day thereafter) beginning on the present Expiration Date hereof and upon

*The contents of this document are subject to restrictions on disclosure as set forth herein.*

each anniversary of such date (or, if such period ends on a day that is not a Business Day, until the next Business Day thereafter), unless at least sixty (60) days prior to any such Expiration Date, Bank has sent Beneficiary written notice, at the address provided below, that Bank elects not to permit this Letter of Credit to be so extended, and will expire on its then-current Expiration Date. No presentation made under this Letter of Credit after such Expiration Date will be honored.

Subject to the terms and conditions herein, funds under this Letter of Credit are available to Beneficiary by valid presentation on or before 5:00 p.m. California time, on or before the Expiration Date of the following:

1. A copy of this Letter of Credit and all amendments; and
2. A copy of the Drawing Certificate in the form of Attachment A attached hereto and which forms an integral part hereof, duly completed and purportedly bearing the signature of an authorized representative of the Beneficiary.

Any full or partial drawing hereunder may be requested by transmitting copies of the requisite documents as described above to the Bank by facsimile at [facsimile number for draws] or such other number as specified from time-to-time by the Bank.

The facsimile transmittal shall be deemed delivered when received. Drawings made by facsimile transmittal are deemed to be the operative instrument without the need of originally signed documents.

Partial drawing of funds shall be permitted under this Letter of Credit, and this Letter of Credit shall remain in full force and effect with respect to any continuing balance; *provided*, the Available Amount shall be reduced by the amount of each such drawing.

This Letter of Credit is not transferable or assignable. Any purported transfer or assignment shall be void and of no force or effect.

All correspondence and any drawings (other than those made by facsimile) hereunder are to be directed to [Bank address/contact].

All notices to Beneficiary shall be in writing and are required to be sent by certified letter, overnight courier, or delivered in person to: Southern California Edison Company, Manager of Credit Risk and Collateral, 2244 Walnut Grove Avenue, GO1 Quad 1D, Rosemead, California 91770. Only notices to Beneficiary meeting the requirements of this paragraph shall be considered valid. Any notice to Beneficiary which is not in accordance with this paragraph shall be void and of no force or effect.

Banking charges shall be the sole responsibility of the Applicant.

This Letter of Credit sets forth in full our obligations and such obligations shall not in any way be modified, amended, amplified or limited by reference to any documents, instruments or agreements referred to herein, except only the attachment referred to herein; and any such reference shall not be deemed to incorporate by reference any document, instrument or agreement except for such attachment. Except in the case of an increase in the Available Amount, this Letter of Credit may not be amended or modified without the Beneficiary’s prior written consent.

The Bank engages with the Beneficiary that Beneficiary’s drafts drawn under and in compliance with the terms of this Letter of Credit will be duly honored if presented to the Bank on or before the Expiration Date.

Except so far as otherwise stated, this Letter of Credit is subject to the International Standby Practices ISP98 (also known as ICC Publication No. 590), or revision currently in effect (the “ISP”). As to matters not covered by the ISP, the laws of the State of California, without regard to the principles of conflicts of laws thereunder, shall govern all matters with respect to this Letter of Credit.

AUTHORIZED SIGNATURE for Bank

\_\_\_\_\_

(Name)

Title: \_\_\_\_\_

**ATTACHMENT A**  
*Drawing Certificate*

TO *[ISSUING BANK NAME]*

IRREVOCABLE NON-TRANSFERABLE STANDBY LETTER OF CREDIT

No. \_\_\_\_\_

DRAWING CERTIFICATE

Bank

Bank Address

Subject: Irrevocable Non-transferable Standby Letter of Credit

Reference Number: \_\_\_\_\_

The undersigned \_\_\_\_\_, an authorized representative of Southern California Edison Company (the “Beneficiary”), hereby certifies to *[Issuing Bank Name]* (the “Bank”), and \_\_\_\_\_ (the “Applicant”), with reference to Irrevocable Non-transferable Standby Letter of Credit No. {\_\_\_\_\_}, dated \_\_\_\_\_, (the “Letter of Credit”), issued by the Bank in favor of the Beneficiary, as follows as of the date hereof:

1. The Beneficiary is entitled to draw under the Letter of Credit an amount equal to \$\_\_\_\_\_, for the following reason(s) [check applicable provision]:
  - ]A. An Event of Default, as defined in that certain Renewable Power Purchase Agreement between Applicant and Beneficiary, dated as of *[Date of Execution]* (as may be amended from time to time, the “Agreement”), with respect to the Applicant has occurred and is continuing.
  - ]B. An Early Termination Date (as defined in the Agreement) has occurred or been designated as a result of an Event of Default (as defined in the Agreement) with respect to the Applicant for which there exist any unsatisfied payment obligations.
  - ]C. The Letter of Credit will expire in fewer than twenty (20) Business Days (as defined in the Agreement) from the date hereof, and Applicant has not provided Beneficiary alternative Development Security or Performance Assurance (as defined in the Agreement) acceptable to Beneficiary.

*The contents of this document are subject to restrictions on disclosure as set forth herein.*

- [ ]D. The Bank or Applicant has heretofore provided written notice to the Beneficiary of the Bank’s or Applicant’s intent not to renew the Letter of Credit following the present Expiration Date thereof, and Applicant has failed to provide the Beneficiary with a replacement letter of credit satisfactory to Beneficiary in its sole discretion within thirty (30) days following the date of the Notice of Non-Renewal.
- [ ]E. The Beneficiary has not been paid any or all of the Applicant’s payment obligations now due and payable under the Agreement.
- [ ]F. The Beneficiary is entitled to retain the entire Development Security: (i) because Commercial Operation Date has not occurred on or before the Commercial Operation Deadline, or any extended Commercial Operation Deadline as provided in the Agreement, or (ii) for any of the reasons set forth in Section 3.06(d) of the Agreement.
- [ ]G. The Beneficiary is entitled to retain a portion of the Development Security pursuant to Section 3.06(f) of the Agreement.

2. Based upon the foregoing, the Beneficiary hereby makes demand under the Letter of Credit for payment of U.S. DOLLARS AND \_\_\_\_/100ths (U.S.\$\_\_\_\_\_), which amount does not exceed (i) the amount set forth in paragraph 1 above, and (ii) the Available Amount under the Letter of Credit as of the date hereof.
3. Funds paid pursuant to the provisions of the Letter of Credit shall be wire transferred to the Beneficiary in accordance with the following instructions:

\_\_\_\_\_

\_\_\_\_\_

\_\_\_\_\_

Unless otherwise provided herein, capitalized terms which are used and not defined herein shall have the meaning given each such term in the Letter of Credit.

IN WITNESS WHEREOF, this Drawing Certificate has been duly executed and delivered on behalf of the Beneficiary by its authorized representative as of this \_\_\_\_ day of \_\_\_\_\_, \_\_\_\_\_.

Beneficiary: SOUTHERN CALIFORNIA EDISON COMPANY

*RAP ID #1242, Pacific Ultrapower Chinese Station*

By:

Name:

Title:

---

*\*\*\* End of EXHIBIT L \*\*\**

*The contents of this document are subject to restrictions on disclosure as set forth herein.*

---



## **EXHIBIT M**

### *CAISO Costs and CAISO Sanctions*

Seller is liable for CAISO Costs and CAISO Sanctions under the circumstances described in this Exhibit M.

1. Determining Applicability of CAISO Costs.

Seller shall be responsible for all CAISO Costs (a) for all Settlement Intervals where Energy Deviations exceed the Performance Tolerance Band and (b) as set forth in Section 1.05(c)(ii).

2. Performance Tolerance Band.

The “Performance Tolerance Band” will equal the quantity in any Settlement Interval, in kWh, that is the product of:

- (a) Three percent (3%) times
- (b) Contract Capacity divided by
- (c) The number of Settlement Intervals in the hour.

3. Seller’s Liability for CAISO Sanctions.

Seller will be liable to reimburse SCE for all CAISO Sanctions incurred by SCE as a result of Seller’s failure to adhere to its obligations under the CAISO Tariff or any CAISO directive, as such directive may be communicated to Seller by SCE, or as set forth in Sections 1.06(b)(ii), 3.12.(g) and 4.01(e).

4. Billing and Documentation of CAISO Costs and CAISO Sanctions.

- (a) The CAISO Costs and CAISO Sanctions will be available for billing approximately one hundred twenty (120) days following the last day of a calendar month in which the event giving rise to the sanction occurs, or thirty (30) days after the CAISO final settlement data is available to SCE, whichever is sooner.
- (b) SCE shall provide to Seller the applicable back-up data used for validating CAISO Costs and CAISO Sanctions.

---

\*\*\* End of EXHIBIT M \*\*\*

## **EXHIBIT N**

### *Actual Availability Report*

Pursuant to Section 3.22, Seller shall prepare an Actual Availability Report in accordance with the procedures described in this Exhibit N.

1. Availability Workbook.

Seller shall:

- (a) Collect the measurement data, listed in Item 2 below, in one (1) or more Microsoft Excel Workbooks (the “Availability Workbook”) provided in a form and naming convention approved by SCE; and
- (b) Electronically send the Availability Workbook to an address provided by SCE.

The Actual Availability Report must reflect the Actual Available Capacity as measured by Seller’s SCADA equipment.

2. Log of Availability.

The Availability Workbook must be created on a single, dedicated worksheet and shall be in the form of Attachment 1 to this Exhibit N.

The data presented in the Availability Workbook must not reflect any electric energy losses between the CAISO Approved Meter or Check Meter and the Delivery Point.

ATTACHMENT 1
Actual Availability Report

Actual Availability Report
[Month]
[NAME] Availability Report
[RAP ID]
All Amounts are in MWh
(Form of Microsoft Excel File Attachment to Email Notice)
Table with columns: Date, HE 1-24 and rows of [mm dd yy]

\*\*\* End of EXHIBIT N \*\*\*

The contents of this document are subject to restrictions on disclosure as set forth herein.

**EXHIBIT O**

[Intentionally Deleted.]

---

\*\*\* *End of EXHIBIT O* \*\*\*