

EXISTING ROW

FACING SOUTH

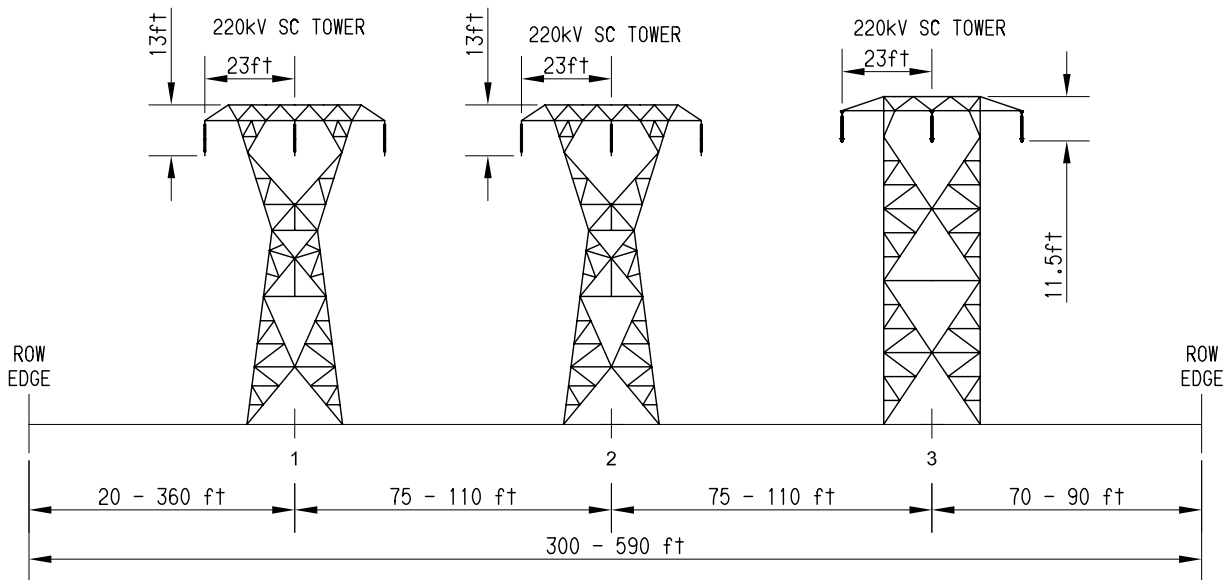

FUTURE ROW

FACING SOUTH

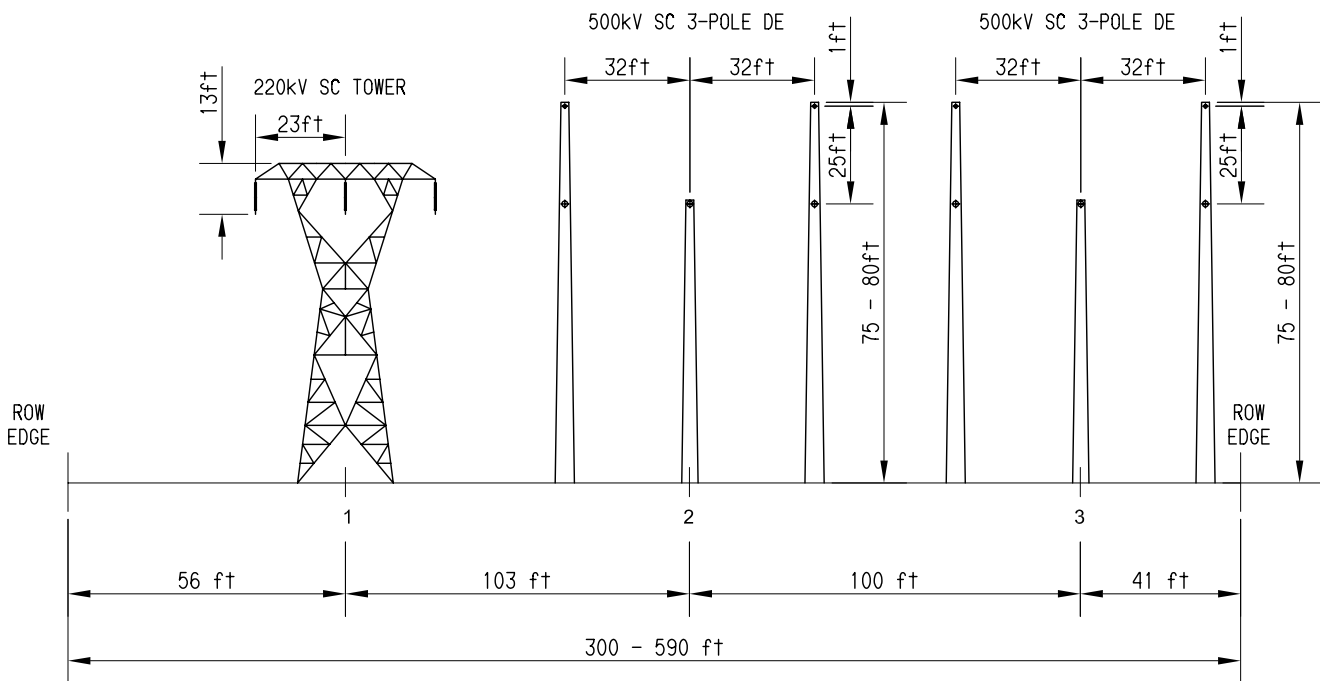

Source: SCE, 2007c.



NOTE:
 This drawing represents potential changes
 between existing and future ROW cross sections.

Figure 2.2-12
 Segment 6 ROW Cross-Section
 (S6 MP 2.2 to S6 MP 2.45)