

EXISTING ROW

FACING SOUTH

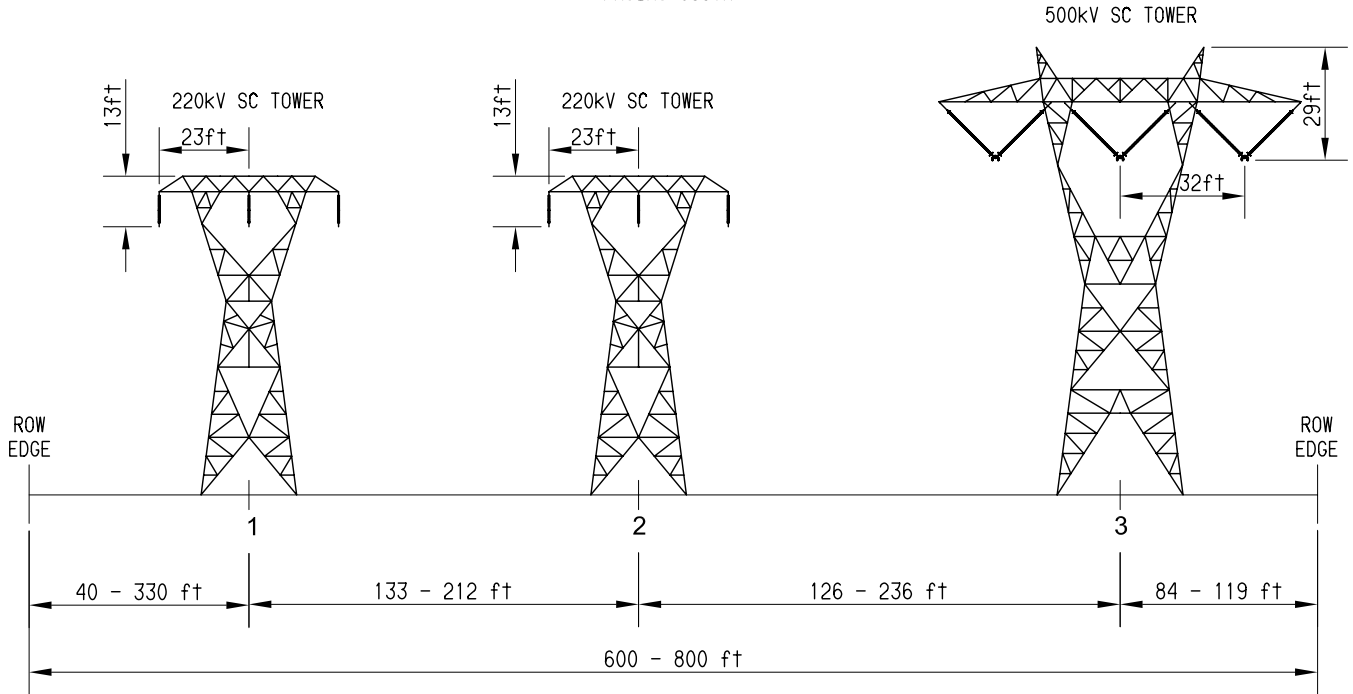

FUTURE ROW

FACING SOUTH

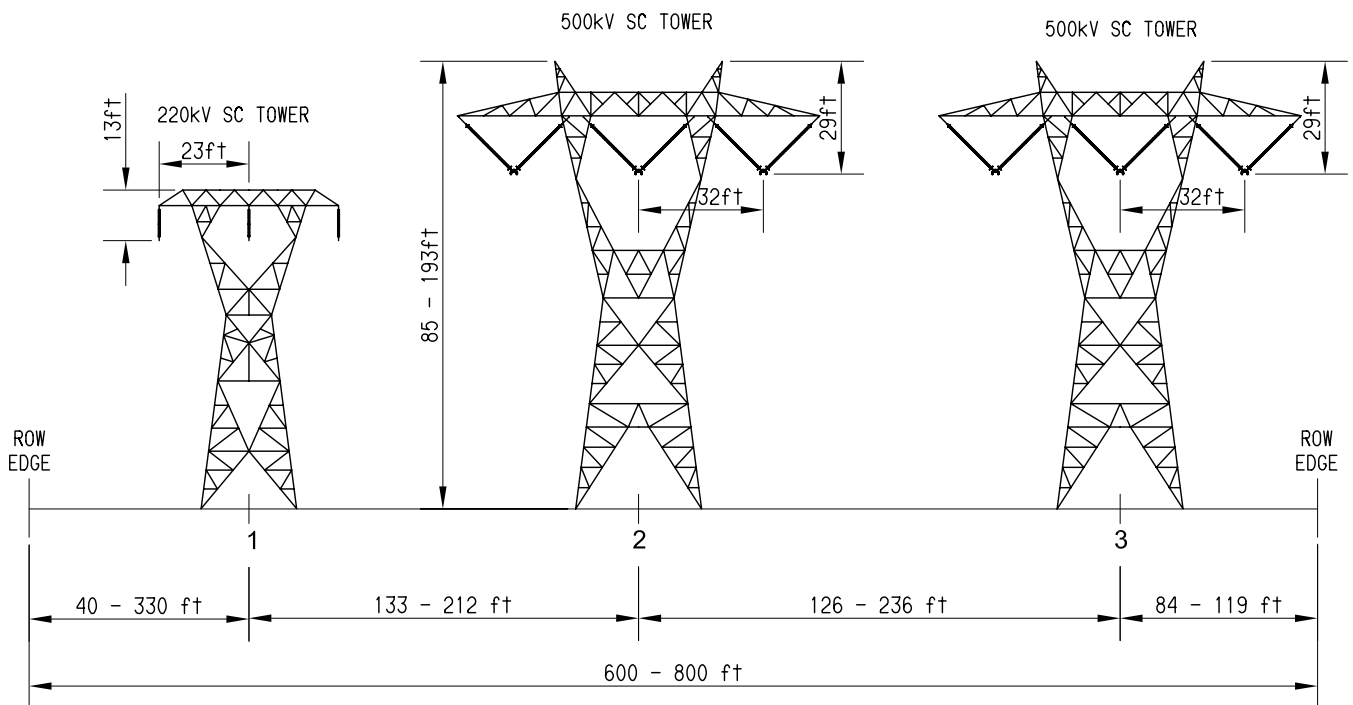

Source: SCE, 2007c.



NOTE:  
This drawing represents potential changes  
between existing and future ROW cross sections.

Figure 2.2-18  
Segment 6 ROW Cross-Section  
(S6 MP 9.5 to S6 MP 26.9)