

EXISTING ROW

FACING EAST

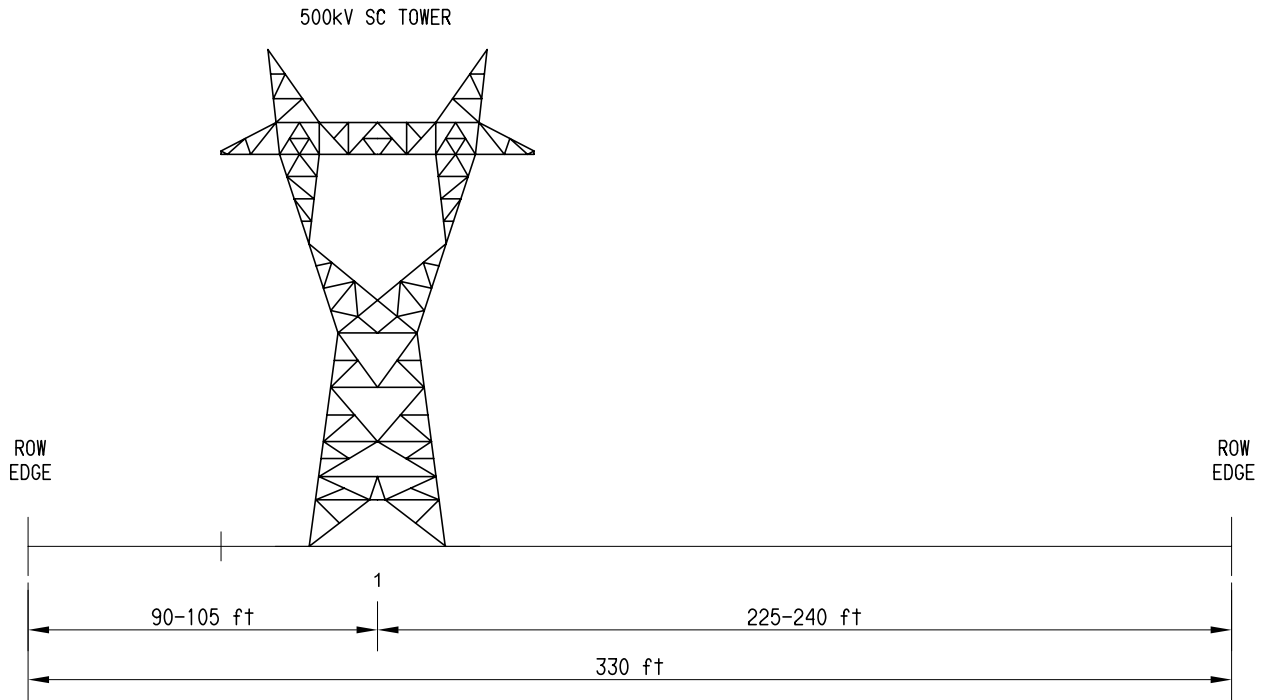

FUTURE ROW

FACING EAST

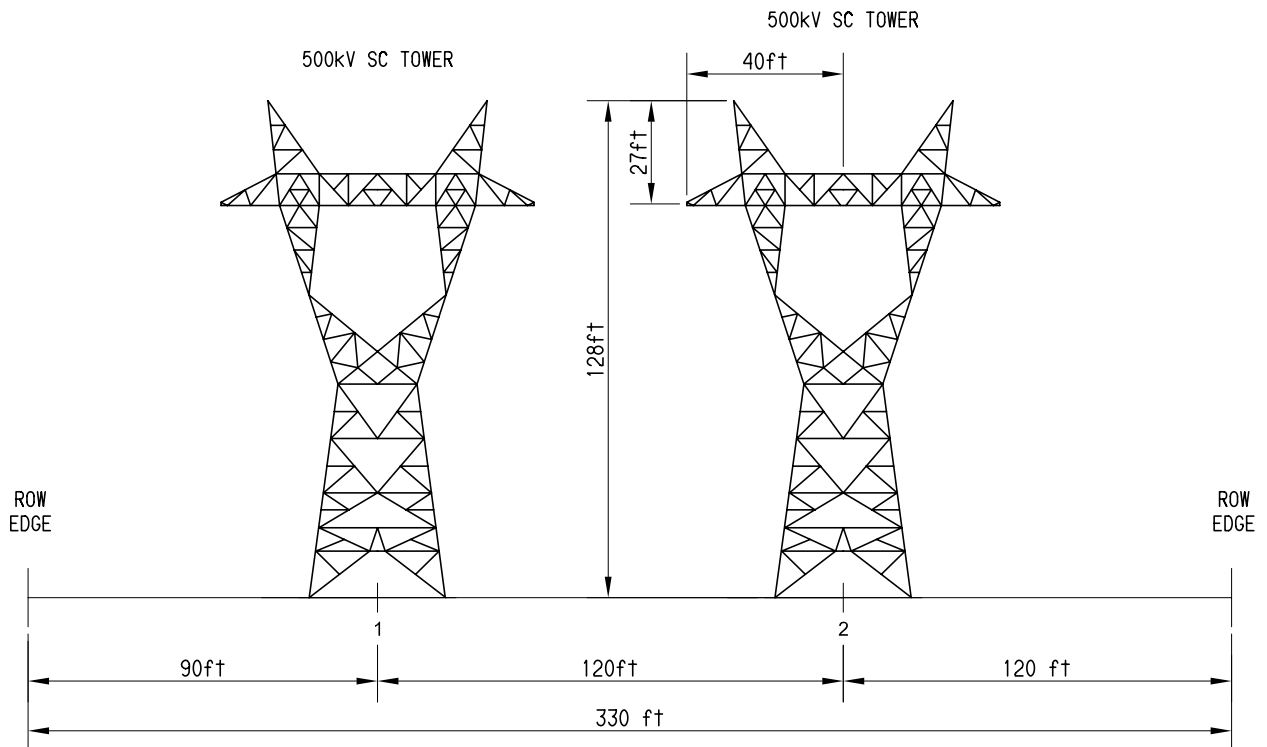

Source: SCE, 2007d.



NOTE:
 This drawing represents potential changes
 between existing and future ROW cross sections.

Figure 2.2-52
Segment 8 ROW Cross-Section
(S8A MP 34.4 to S8A MP 34.5)