

EXISTING ROW

FACING SOUTH

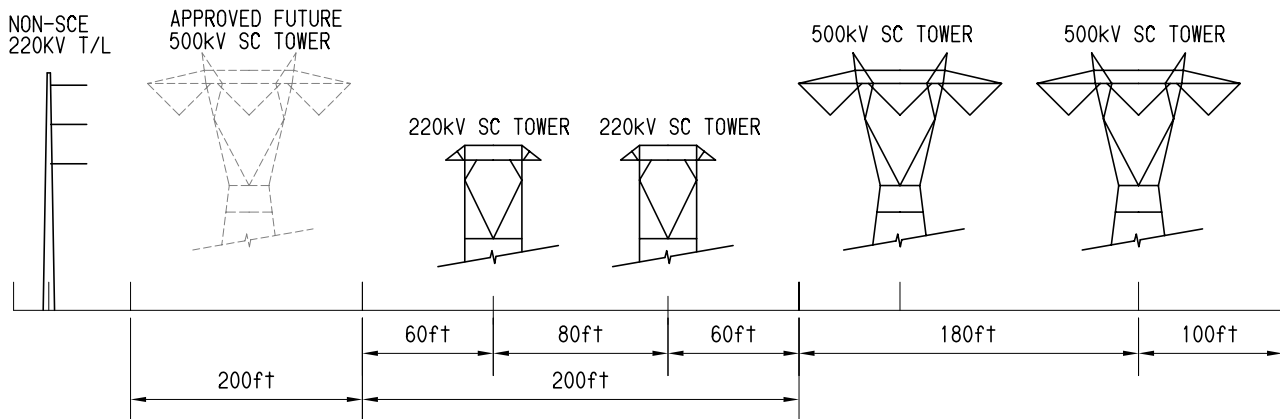

FUTURE ROW

FACING SOUTH

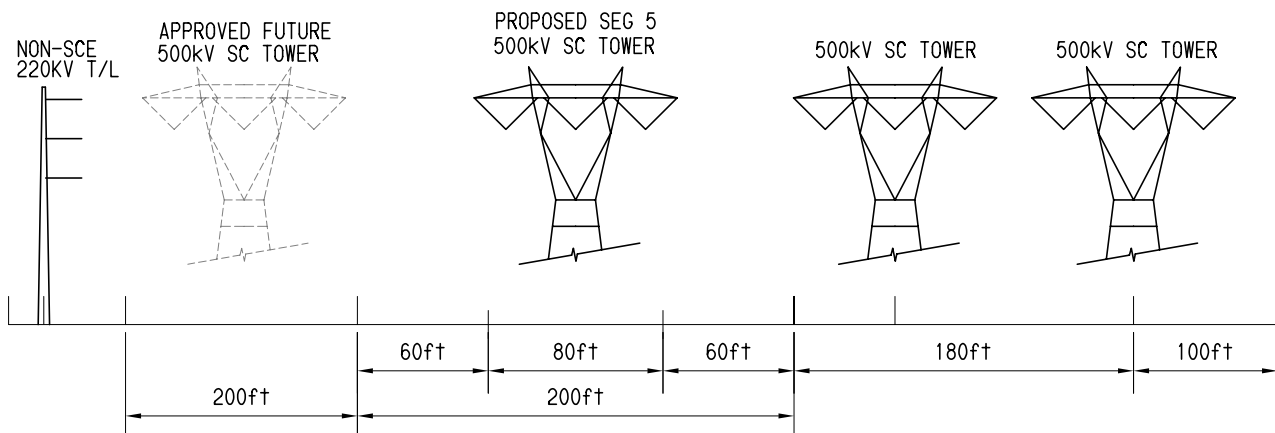

NOTE:
 This drawing represents potential changes
 between existing and future ROW cross sections.

Source: SCE, 2007c.

Figure 2.2-9
Segment 5 ROW Cross-Section
(S5 MP 15.9 to S5 MP 17.8)